



(D) Montageanleitung

(GB) Assembly instructions

(FR) Notice de montage

(TR) Montaj talimatı

(IT) Istruzioni di montaggio

(NL) Handleiding voor de montage

(RU) Инструкция по монтажу

(CZ) Montážní návod

(HU) Szerelési útmutató

(RO) Instrucțiuni de montaj

(PL) Instrukcja montażu

(SK) Návod na montáž

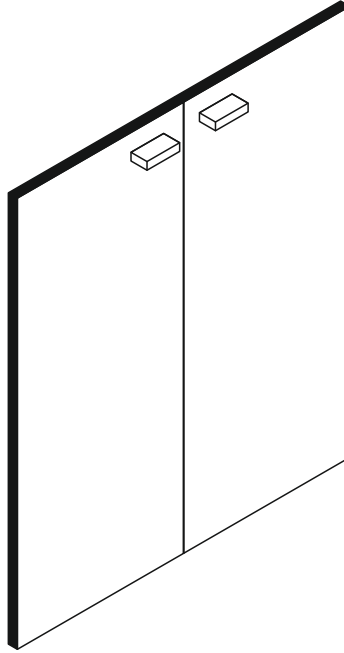

0202_2T Türen



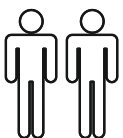
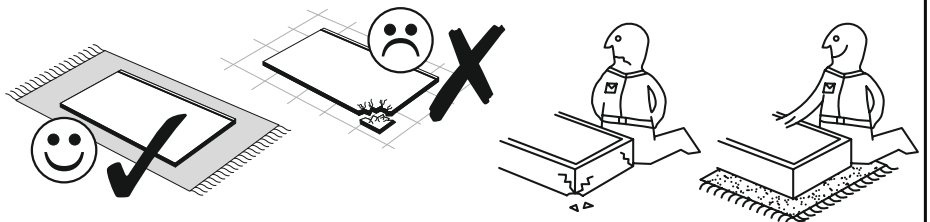
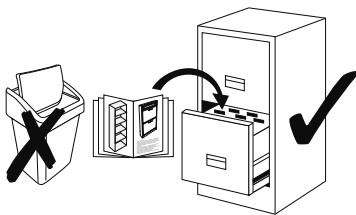
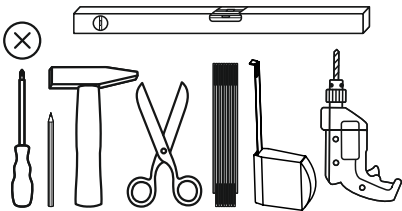

REPC-Nr.:

Service • Assistenza • Dienstverlening • Serwis
Servis • Szerviz • Сервисная служба



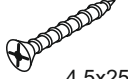

Colli 1/1: ① Beutel 1/2, 2/2

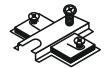
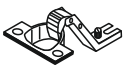
Beutel 1/2

1-37	 4,5x25	1-80	 3,5x13	1-329	 M4x22	3-07		3-11		3-43	
1x		8x		4x		2x		4x		4x	15er

Beutel 2/2

3-130		6-401	
4x		2x	

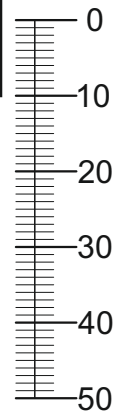

Colli 1/1

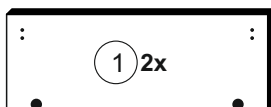

1036 x 381

1

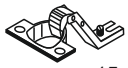
1-80		3-43		1
8x	3,5x13	4x	15er	

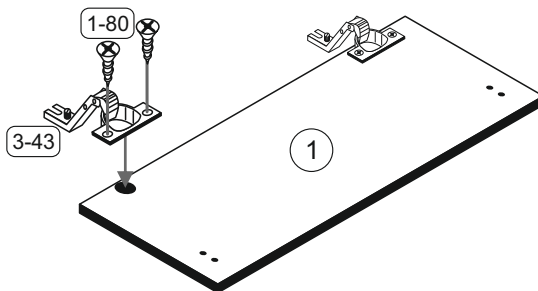

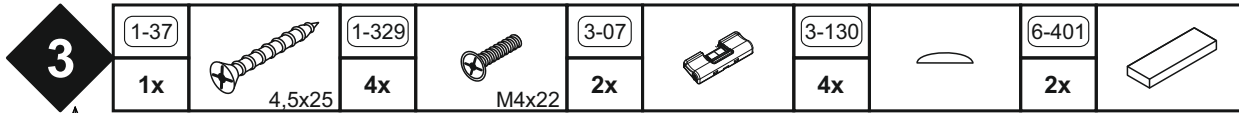
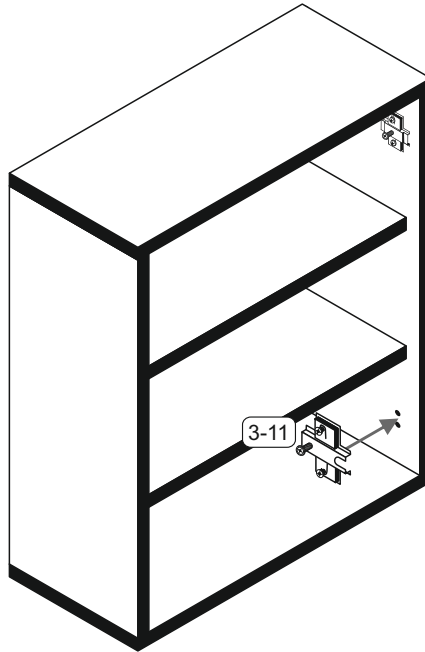
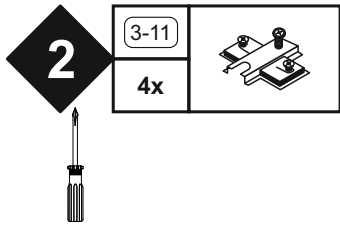

Montage der Türdämpfung

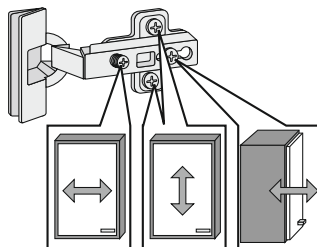
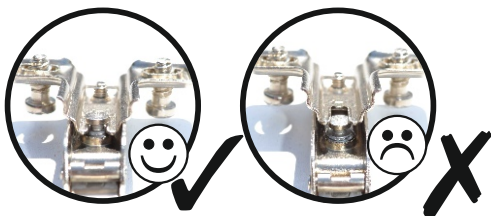
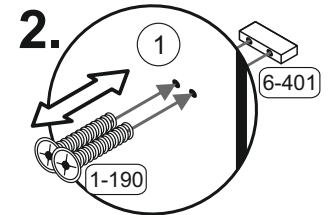
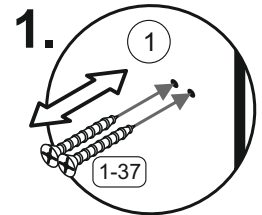
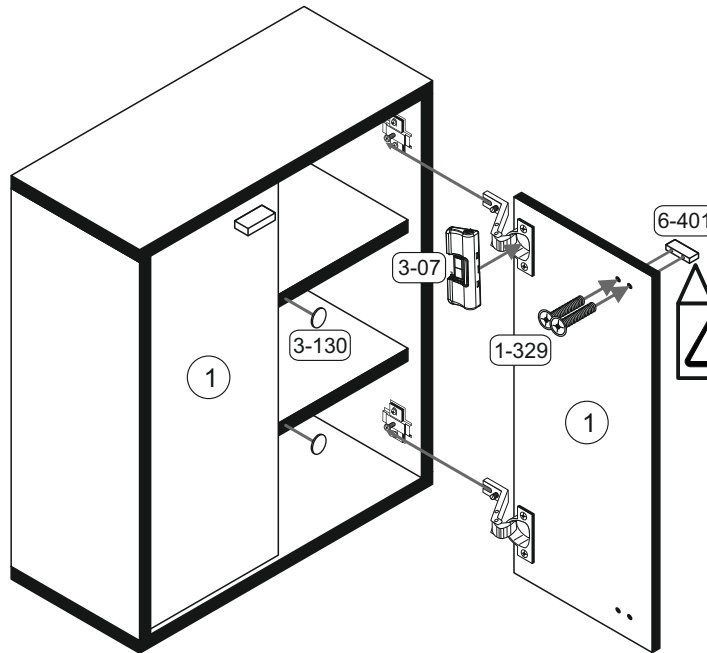
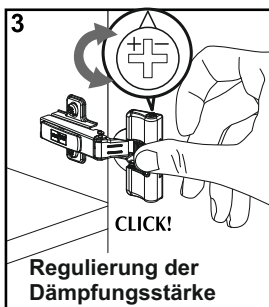
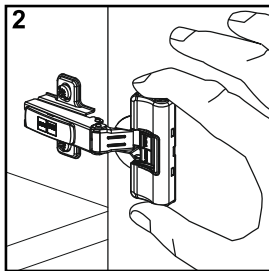
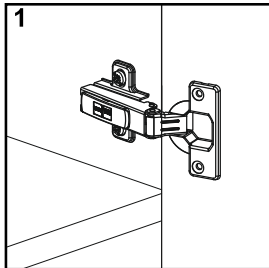

- Türen einstellen (Scharniere justieren)
- Adjusting the doors (adjusting the hinges)
- Régler les portes (ajuster les charnières)
- Sistemare le porte (regolare le cerniere)
- Deuren instellen (scharnieren afstellen)
- Nastawić drzwi (wyregulować zawiasy)
- Vyrovnejte dvířka (seřid'te závěsy)
- Nastavenie dverí (nastavenie závesov)
- Állítsa be az ajtókat (állítsa be a zsanérokot)
- Reglare uși (ajustare balamale)
- Kapların ayarlanması (menteselerin seviye ayarı)
- Регулировка дверей (регулировка шарнира)