

2473

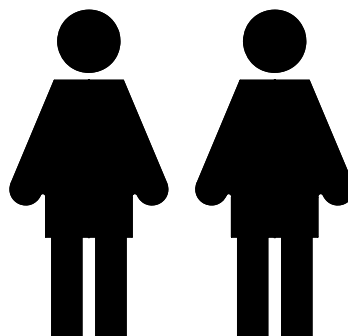
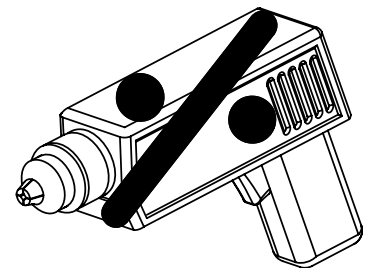
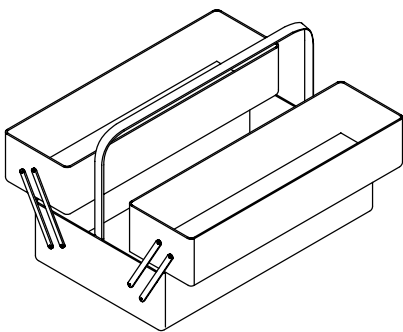
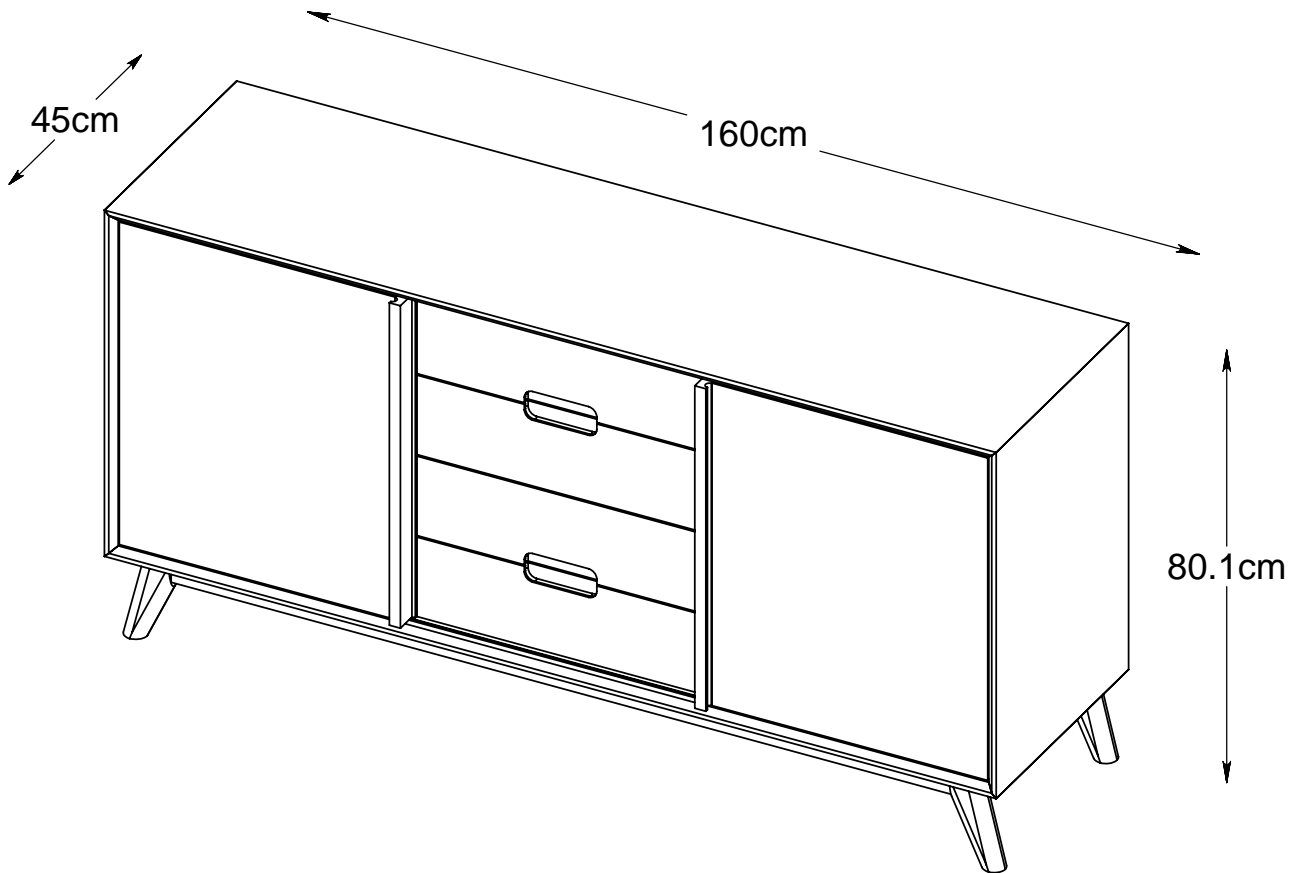

WICHTIG - FÜR SPÄTERE VERWENDUNG
AUFBEWAHREN - SORGFÄLTIG LESEN

IMPORTANTE, conservare per utilizzi futuri,
leggere attentamente.

VIGTIGT - Samlevejledningen skal opbevares
i arkiv til senere brug - Skal gennemlæses nøje

NOTICE - These instructions must be saved
for future use - Instructions must be followed

IMPORTANT - Veuillez conserver
la notice de montage dans le cadre
d'une prochaine utilisation.
Parcourir cette notice avec attention

1

