

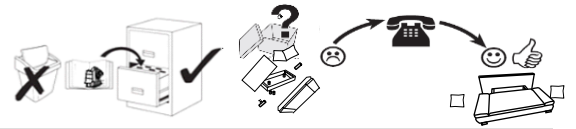

05/04.2022



- GB** ASSEMBLY INSTRUCTIONS  
INSTRUKTION MANUAL
- DE** MONTAGEANLEITUNG  
BEDINUNGSANLEITUNG
- HU** SZERELÉSI ÚTMUTATÓ  
HASZNÁLATI UTASÍTÁS
- FR** NOTICE DE MONTAGE  
MANUEL D'INSTRUCTION
- SI** NAVODILA ZA MONTAŽO  
NAVODILA ZA UPORABO
- HR** UPUTE ZA MONTAŽU  
UPUTE ZA UPOTREBU

- SK** MONTÁŽNY NÁVOD  
NÁVOD NA OBSLUHU
- PL** INSTRUKCJA MONTAŻU  
INSTRUKCJA OBSŁUGI
- CZ** MONTÁŽNÍ NÁVOD  
NÁVOD K OBSLUZE
- TR** MONTAJ TALIMATI  
KILAVUZUNU
- ES** INSTRUCCIONES DE MONTAJE  
MANUAL DEL USUARIO

- IT** ISTRUZIONI DI MONTAGGIO  
MANUALE DI ISTRUZIONI
- RU** ИНСТРУКЦИЯ ПО МОНТАЖУ  
ИНСТРУКЦИЯ
- RO** INSTRUCȚIUNI DE INSTALARE  
INSTRUCȚIUNI DE UTILIZARE
- NL** HANDLEIDING VOOR DE MONTAGE  
GEBRUIKAANWIJZING
- PT** INSTRUÇÕES DE MONTAGEM  
MANUAL DO USUÁRIO

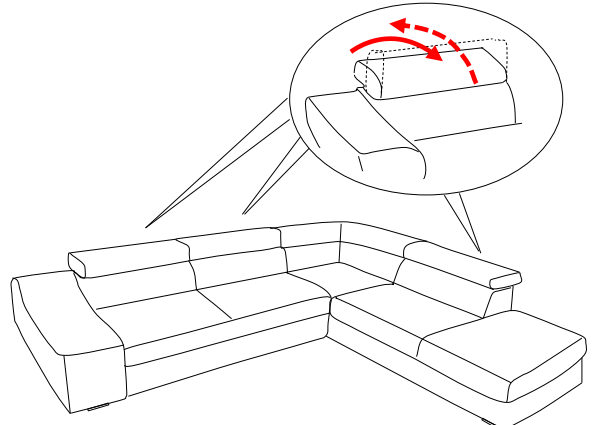
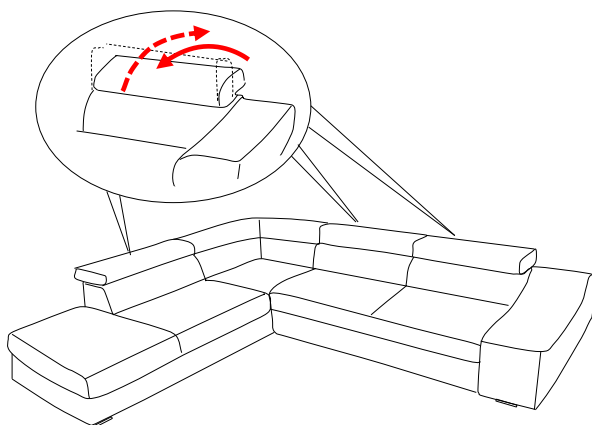
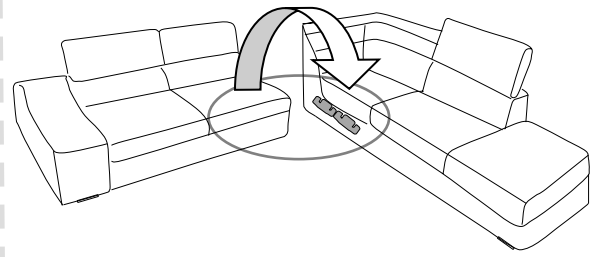
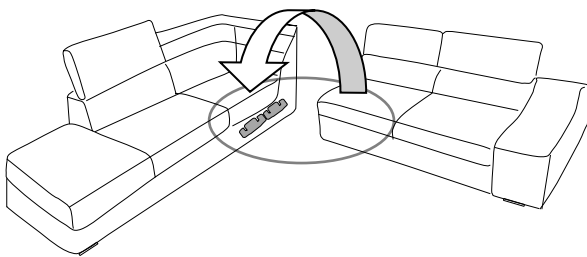
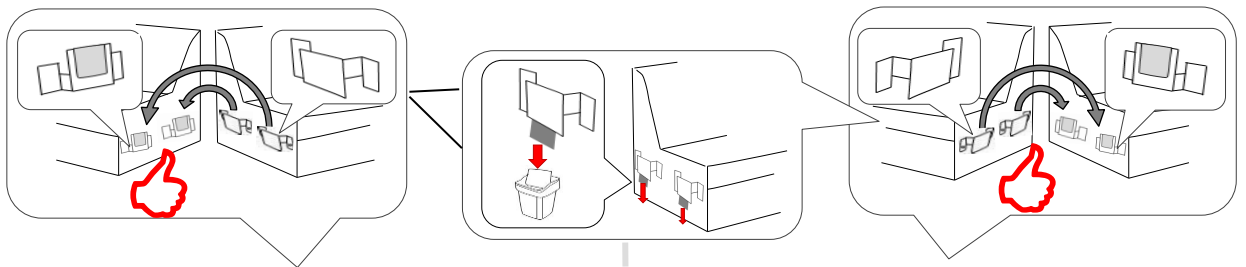
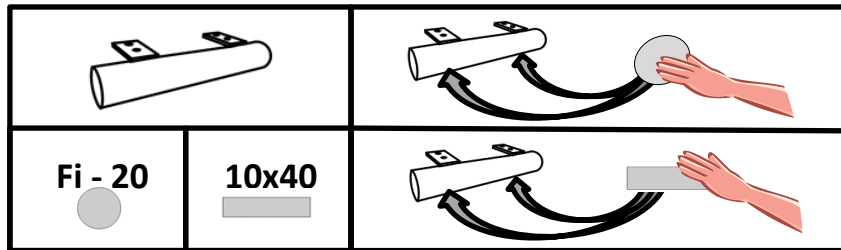
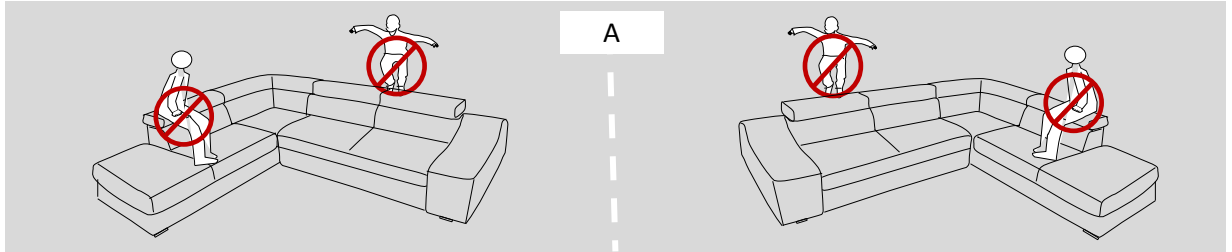

Broadway  
Catwalk

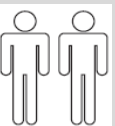

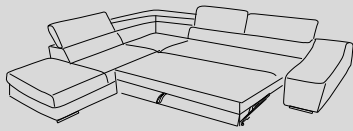

B



1

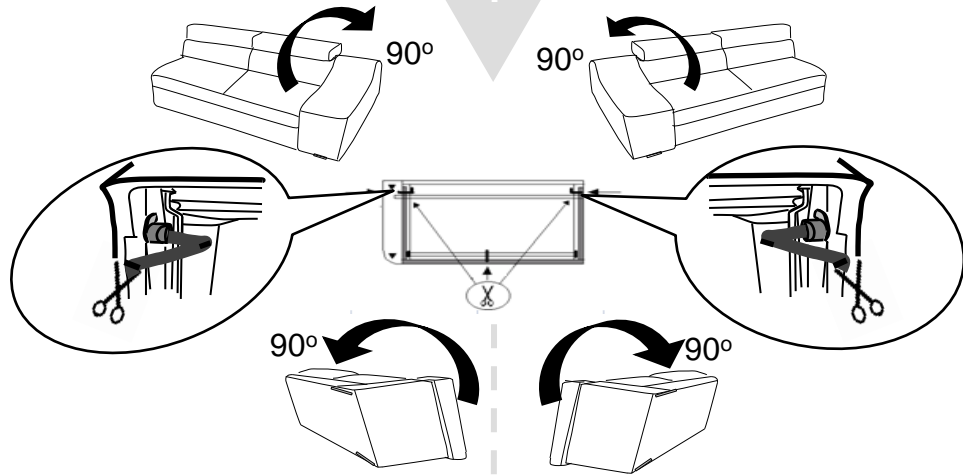

2

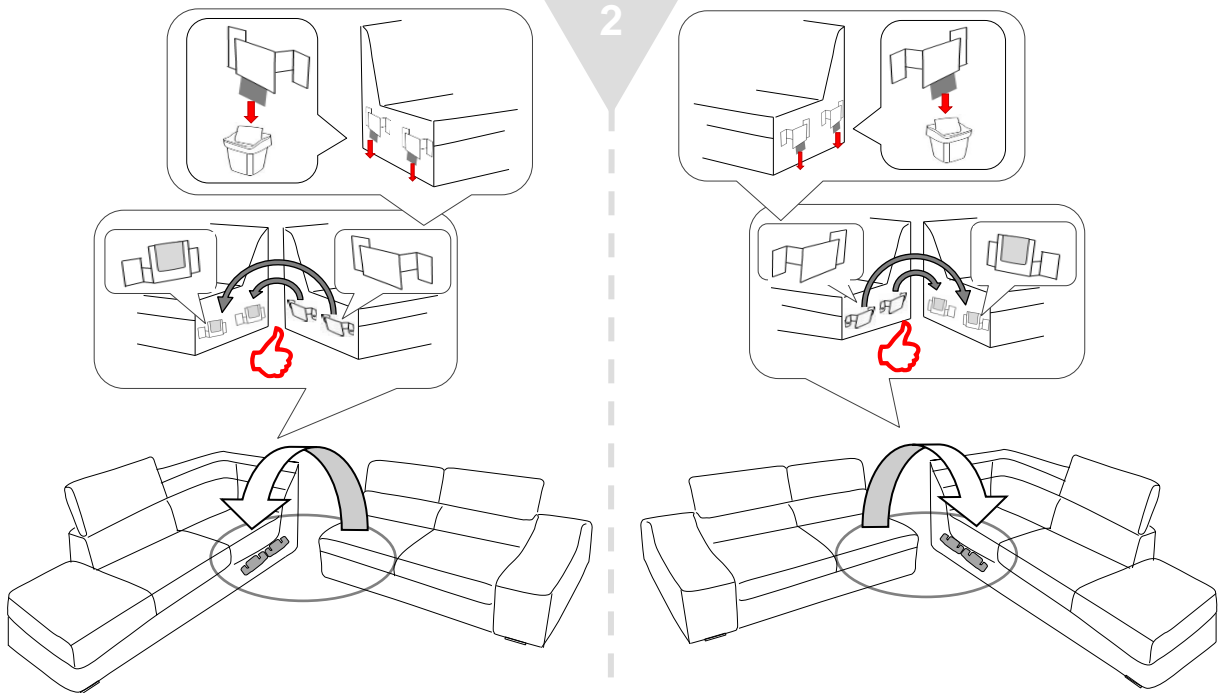

3

