

(D) Montageanleitung

(GB) Assembly instructions

(CZ) Montážní návod

(SK) Návod na montáž

(FR) Notice de montage

(IT) Istruzioni di montaggio

(HU) Szerelési útmutató

(RU) Инструкцини де монтаж

(NL) Handleiding voor de montage

(PL) Instrukcja montażu

(TR) Montaj talimati

(RU) Инструкция по монтажу



"HILTON"



E

D

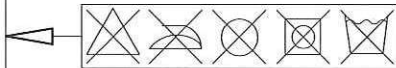

D

E

E

C

A

B

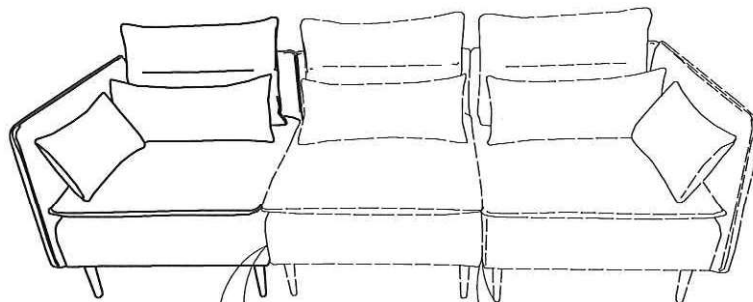
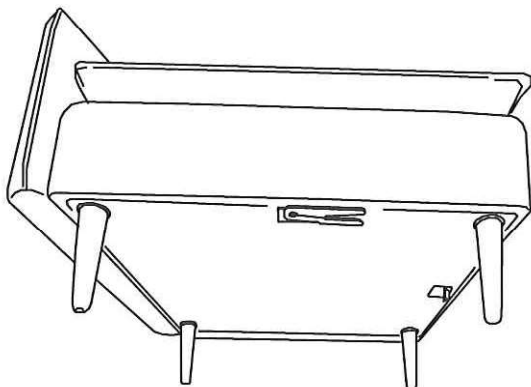
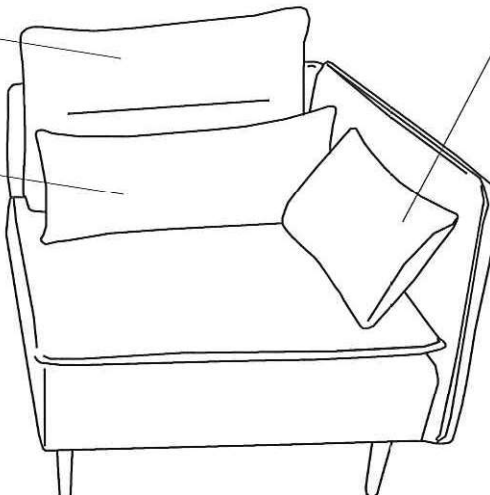
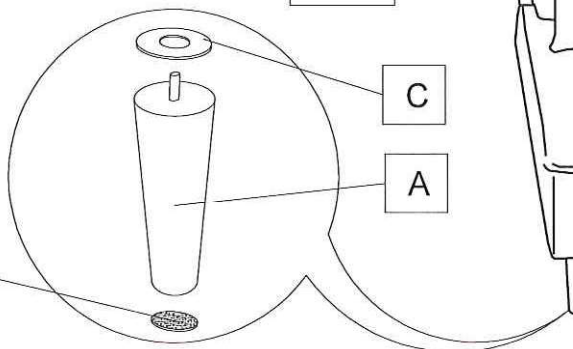

A



x4

B



x4

C

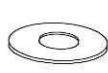

x4

D

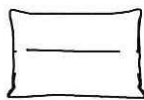

x1

E

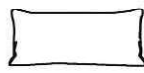

x2

Service \* Assistenza \* Dienstverlening \* Serwis \* Servis \* Szerviz \* Сервисная служба

Name \* Nom \* Nome \* Naaz \* Nazwa \* Jméno  
 Názov \* Név \* Denumire \* Isim \* Название

"HILTON"

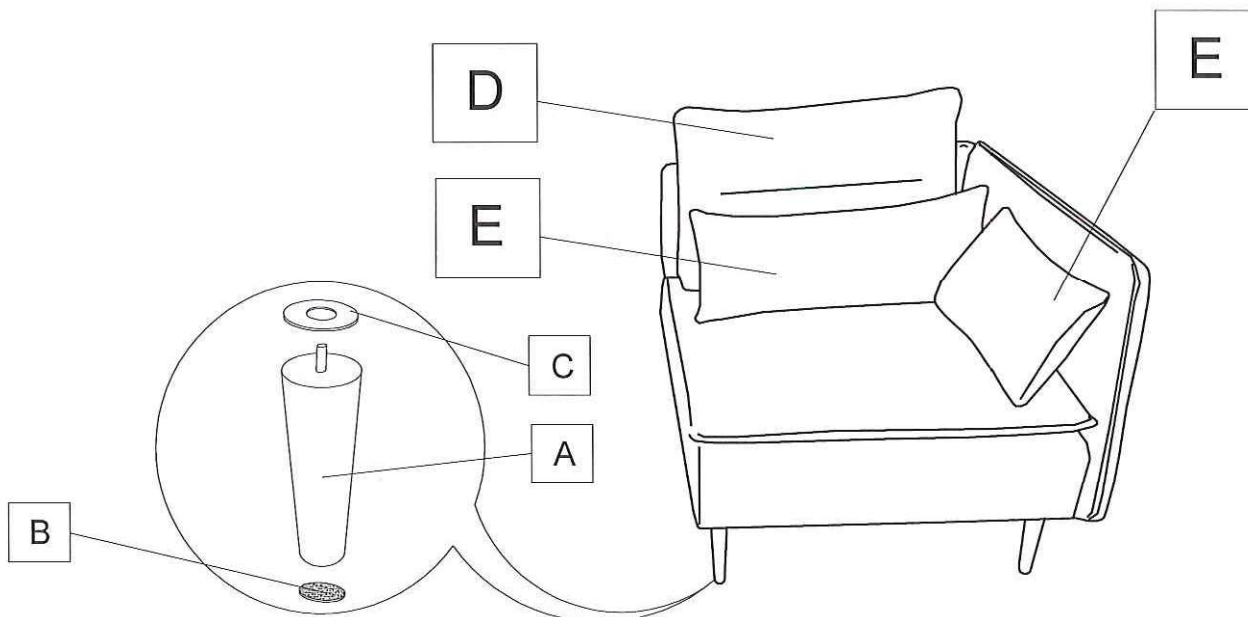
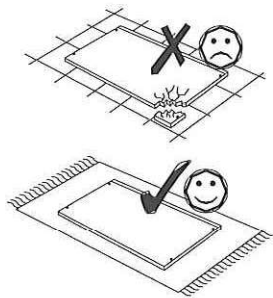
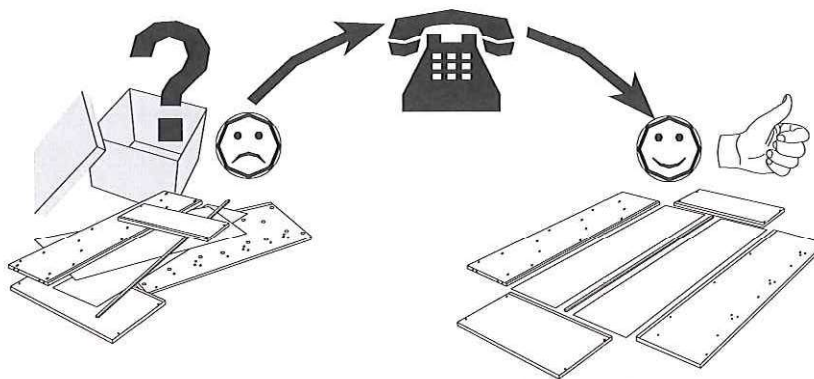
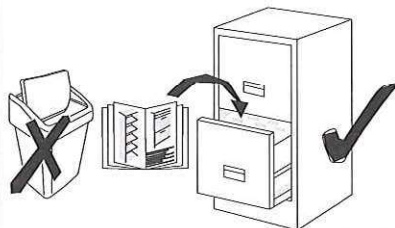

A	B	C	D	E
X....	X....	X....	X....	X....