

MONTAGEANLEITUNG ASSEMBLY INSTRUCTION

“Maxi”

ART.-NR. 500 660



ROLAND WERK GmbH

Industriestraße 16

49681 Garrel





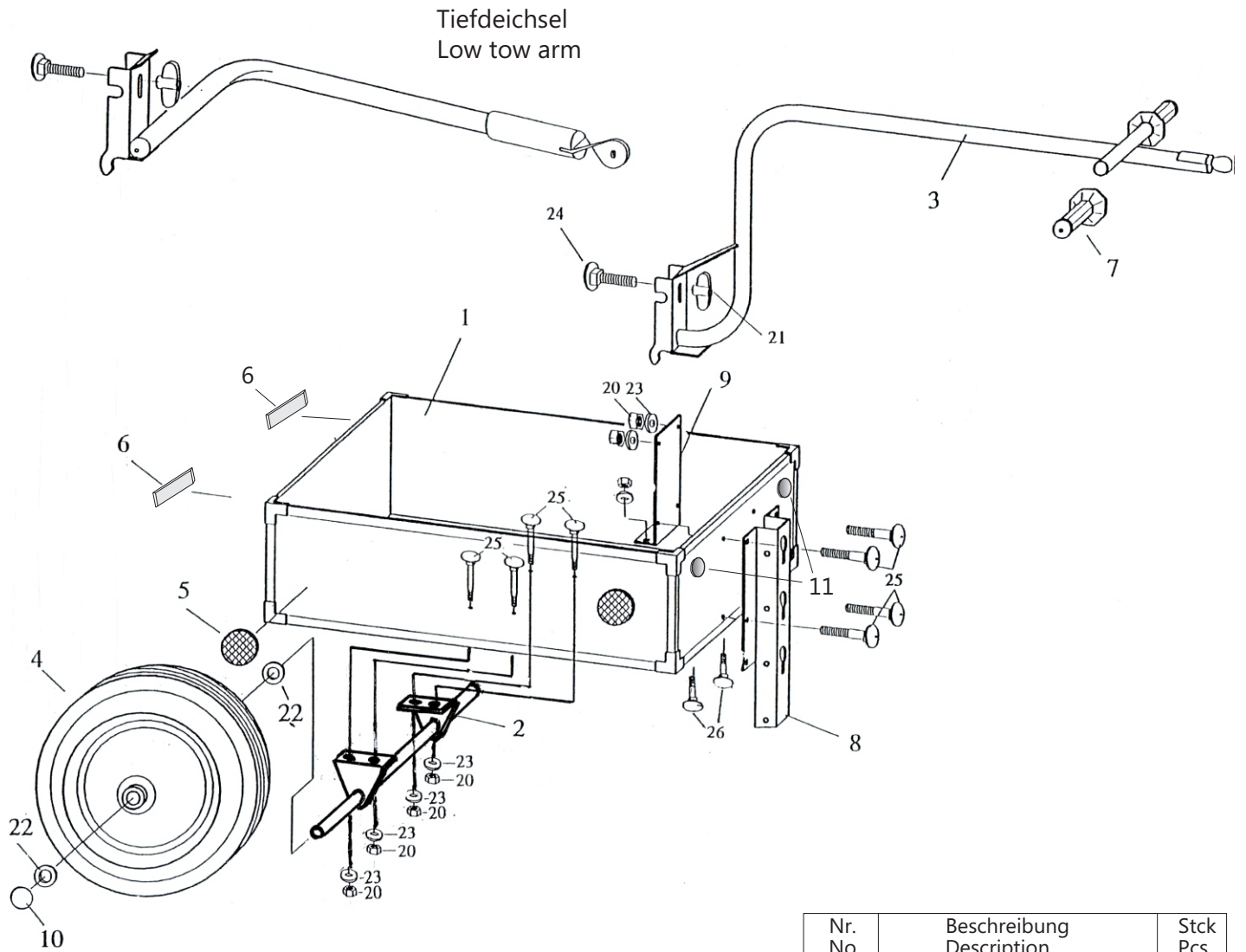

Tel.: 0 44 74 / 94 83-0

Fax: 0 44 74 / 94 83-33

www.roland-werk.de

MONTAGEANLEITUNG ASSEMBLY INSTRUCTION



<p>20</p>  10 x Mutter Nut M6	<p>21</p>  1 x Flügelmutter Wing nut M8	<p>22</p>  4 x Scheibe Washer \varnothing 21	<p>23</p>  10 x Scheibe Washer \varnothing 6.4
<p>24</p>  1 x Schraube Screw M8 x 25	<p>25</p>  8 x Schraube Screw M6 x 25	<p>26</p>  2 x Schraube Screw M6 x 20	

Nr. No.	Beschreibung Description	Stck Pcs
1	Kasten Box	1
2	Achse Axle	1
3	Deichsel Tow arm	1
4	Scheibenräder Disk wheels	2
5	Reflektor gelb Reflector yellow	4
6	Z-Reflektor rot Z-Reflector red	1
7	Kunststoffgriffe Plastic handle bars	2
8	Deichselaufnahme Tow arm adapter	1
9	Verstärkungswinkel Reinforcing elbow	1
10	Stahlkappe Steel bar	2
11	Reflektor weiß Reflector white	2