

MORRIS  
8141/2503  
2501/8142

- |           |  |           |   |
|-----------|--|-----------|---|
| <b>D</b>  | MONTAGEANLEITUNG<br>BEDIENUNGSANLEITUNG                | <b>GB</b> | ASSEMBLY INSTRUCTIONS<br>INSTRUCTION MANUAL         |
| <b>NL</b> | HANDLEIDING VOOR DE MONTAGE<br>GEBRUIKSAANWIJZING      | <b>PL</b> | INSTRUKCJA MONTAŻU<br>INSTRUKCJA OBSŁUGI            |
| <b>TR</b> | MONTAJ TALIMATI<br>KULLANIM KLAVUZU                    | <b>RU</b> | ИНСТРУКЦИЯ ПО МОНТАЖУ<br>ИНСТРУКЦИЯ ПО ЭКСПЛУАТАЦИИ |
| <b>RO</b> | INSTRUCȚIUNI DE INSTALARE<br>INSTRUCȚIUNI DE UTILIZARE | <b>IT</b> | ISTRUZIONI DI MONTAGGIO<br>MANUALE DI ISTRUZIONI    |
| <b>FR</b> | NOTICE DE MONTAGE<br>MANUEL INSTRUCTIONS               | <b>SK</b> | MONTÁŽNY NÁVOD<br>NÁVOD NA POUŽITIE                 |
| <b>HU</b> | KÖZGYŰLÉS UTASÍTÁSOK<br>KEZELÉSI UTASÍTÁS              | <b>CZ</b> | MONTÁŽNÍ NÁVOD<br>NÁVOD K POUŽITÍ                   |
| <b>SI</b> | NAVODILA ZA MONTAŽO<br>NAVODILA ZA UPORABO             | <b>PT</b> | INSTRUÇÕES DE MONTAGEM<br>MANUAL DO USUÁRIO         |
| <b>ES</b> | INSTRUCCIONES DE MONTAJE<br>MANUAL DEL USUARIO         | <b>HR</b> | UPUTE ZA MONTAŽU<br>UPUTE ZA UPOTREBU               |

**F/B**

230105

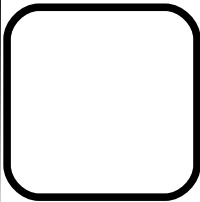
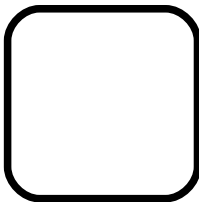

0019

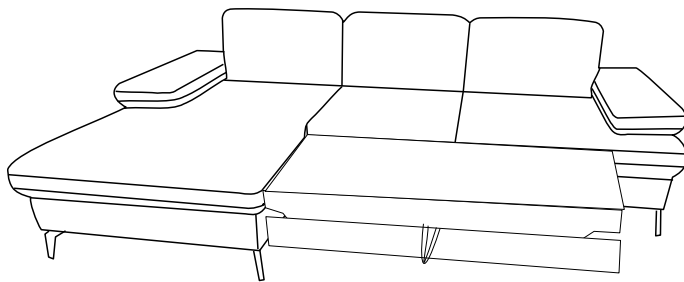
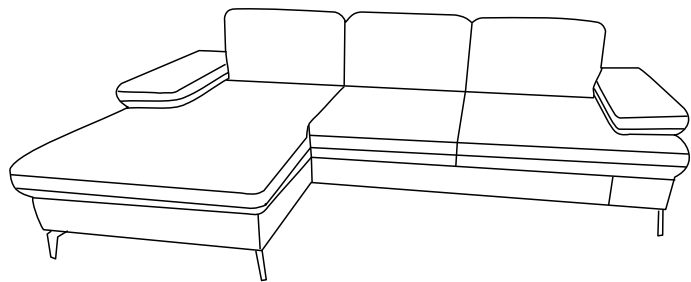

0019

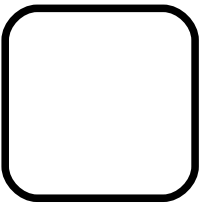
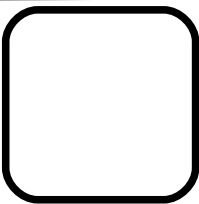

0089

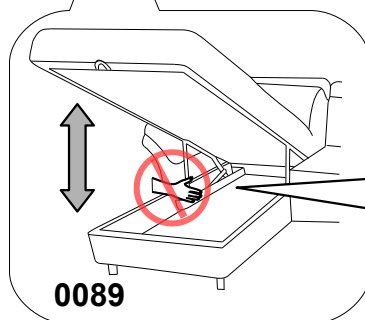
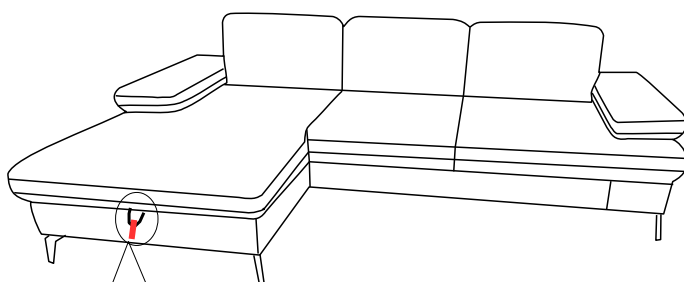
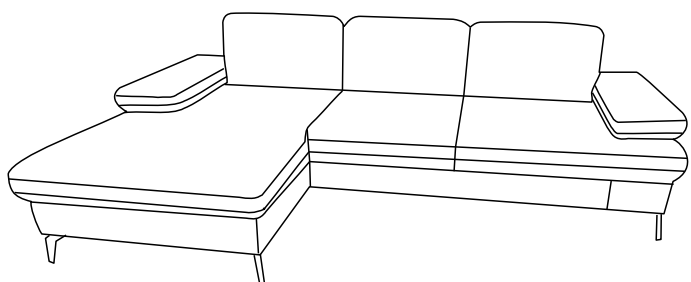
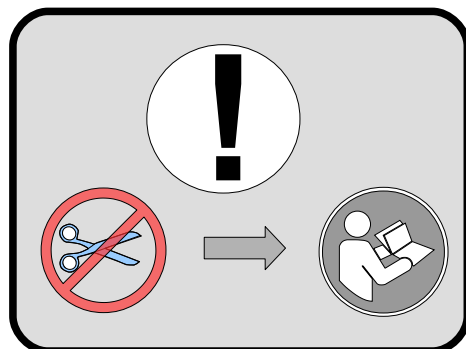

0089

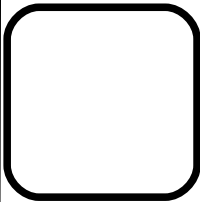
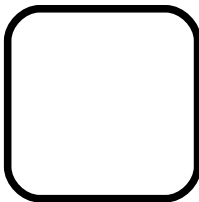

0037

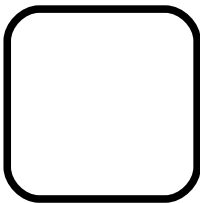
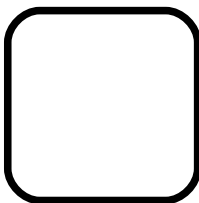
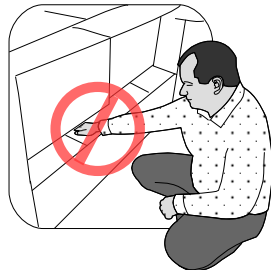
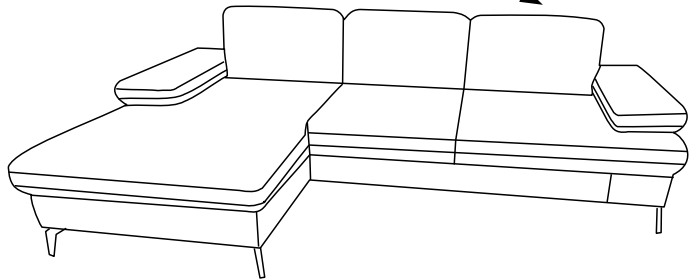
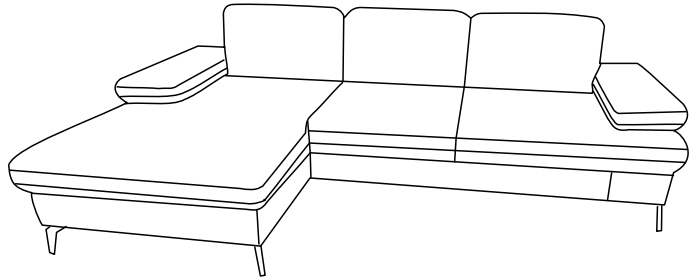
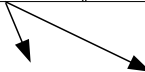
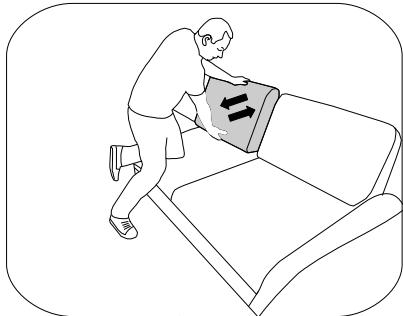

0090

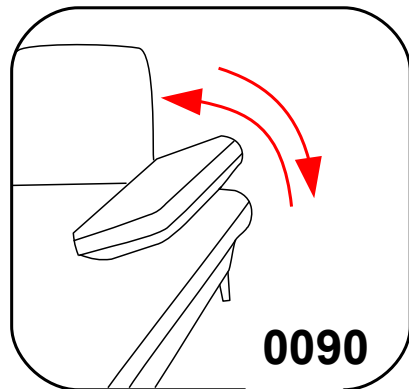

0090

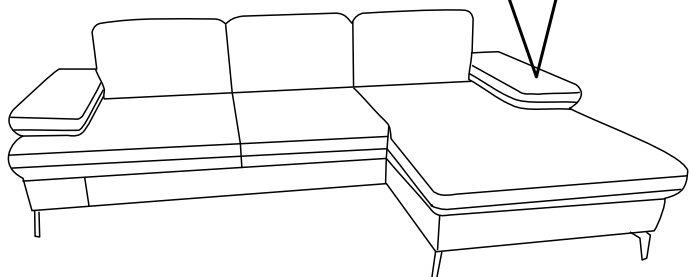
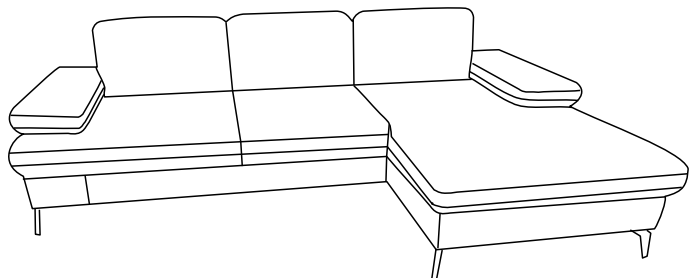

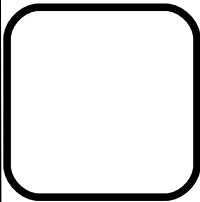
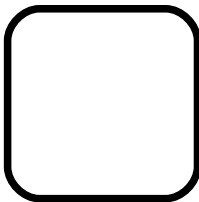

0090

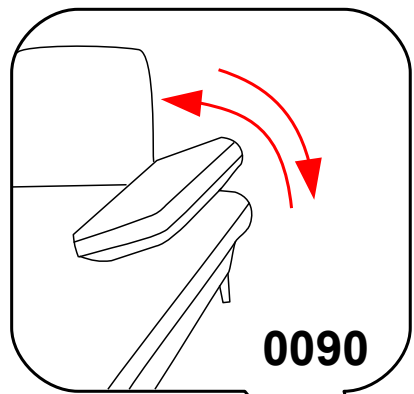

0090

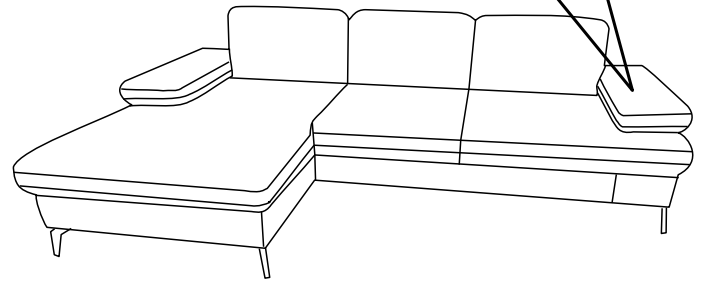
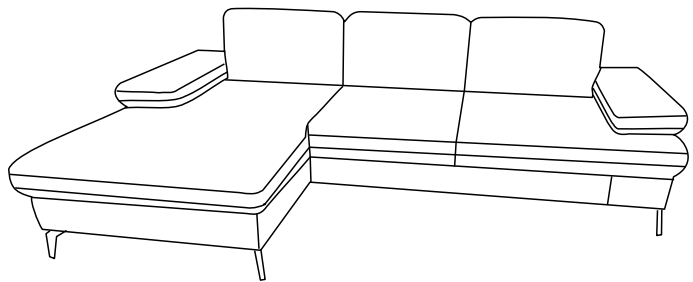

L

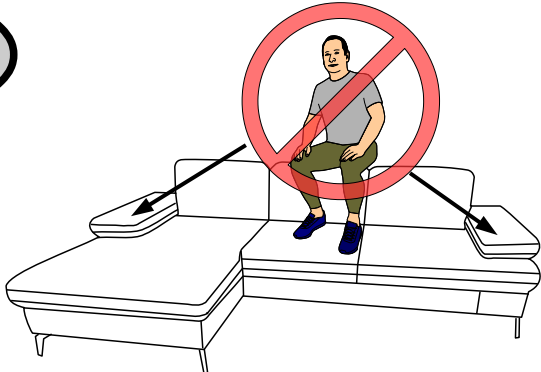

R

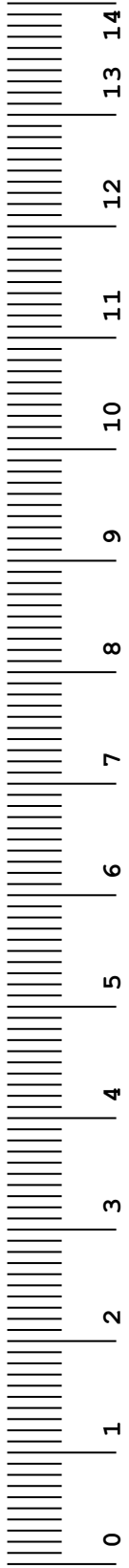
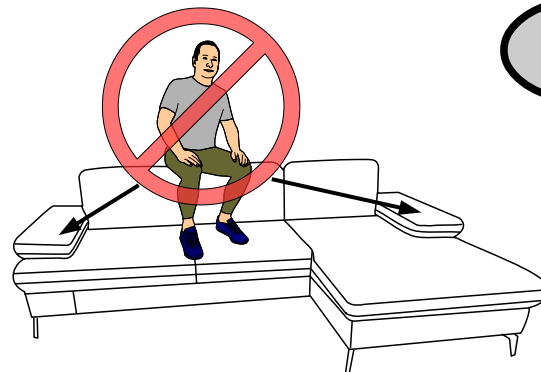

<b>g</b> H-120/150  X2	<b>v</b> H-120/150  X1	<b>i</b> L-4  X1	<b>S</b> H-120/150  X3	<b>q</b> M6*25 [mm]  X12
------------------------------	------------------------------	------------------------	------------------------------	--------------------------------

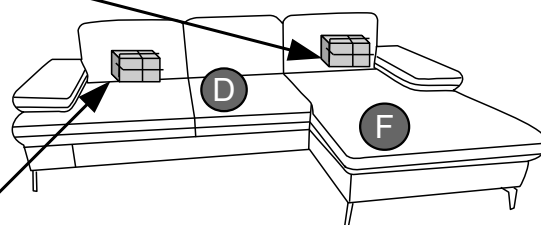
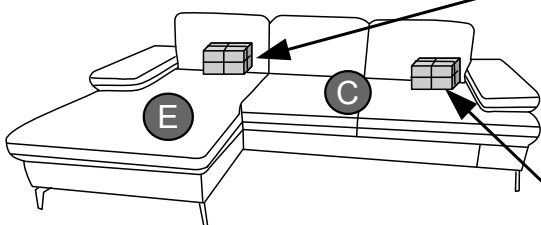

<b>g</b> H-120/150  X2	<b>i</b> L-4  X1	<b>S</b> H-120/150  X2	<b>q</b> M6*25  X8
------------------------------	------------------------	------------------------------	--------------------------

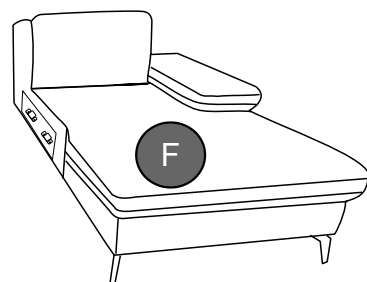
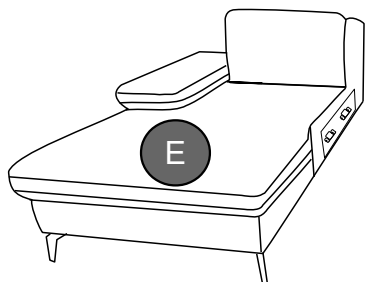
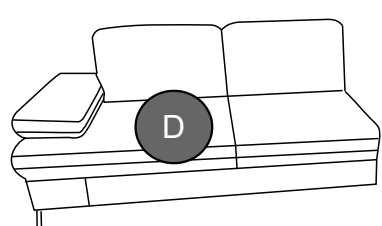
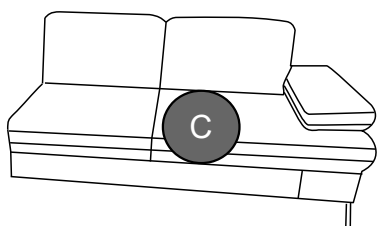

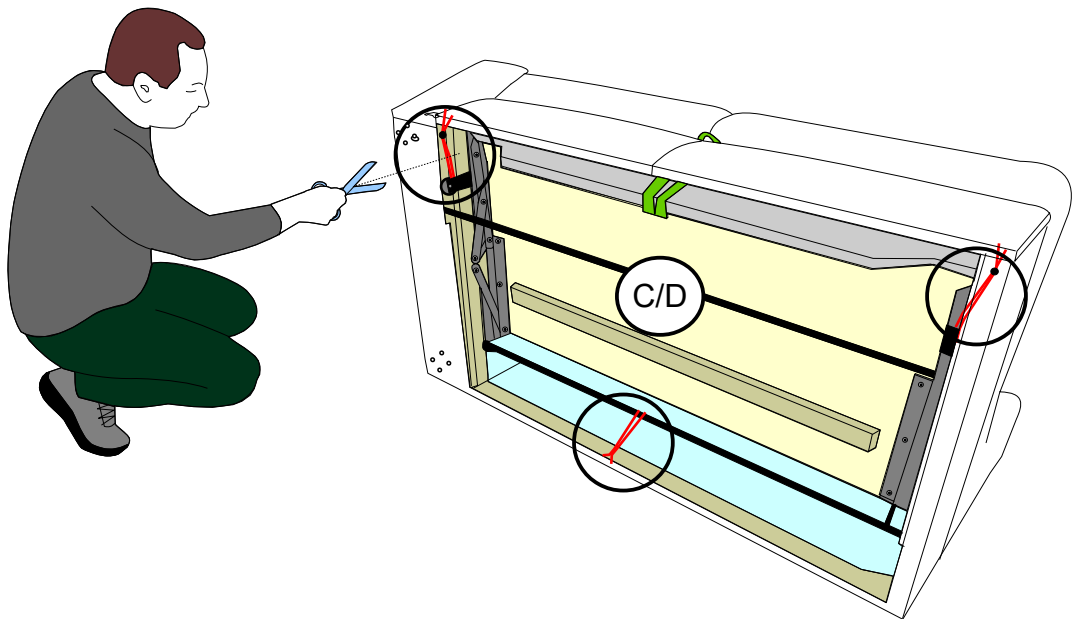
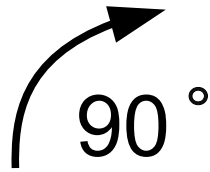
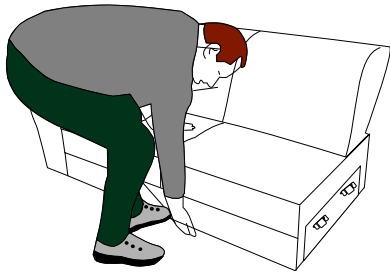

0019

**g** H-120/150

X4

**v** H-120/150

X1

**i** L-4

X1

**S** H-120/150

**s**<sub>1</sub>

X5

**q** M6\*25

X20

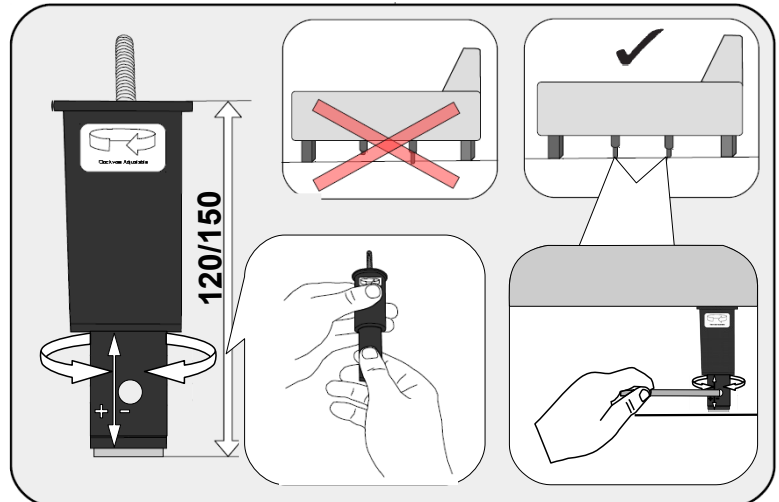
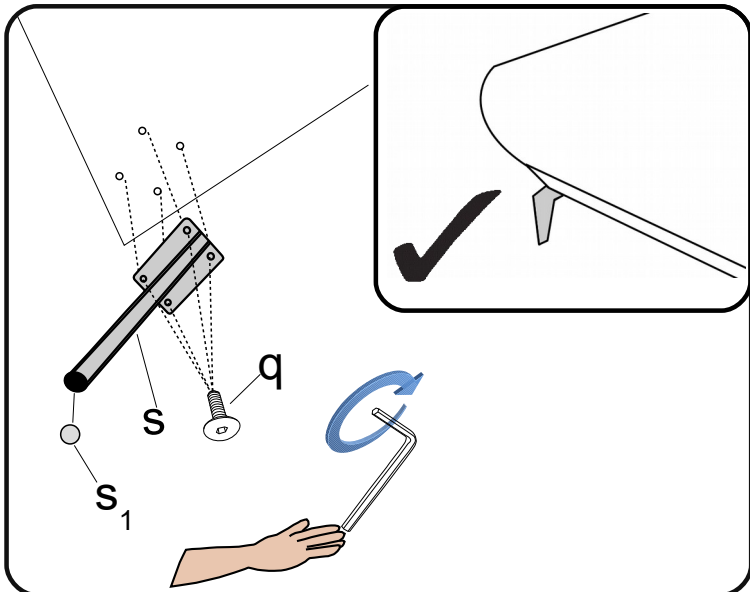
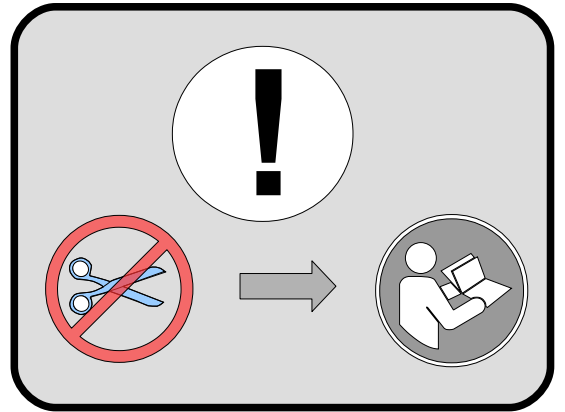
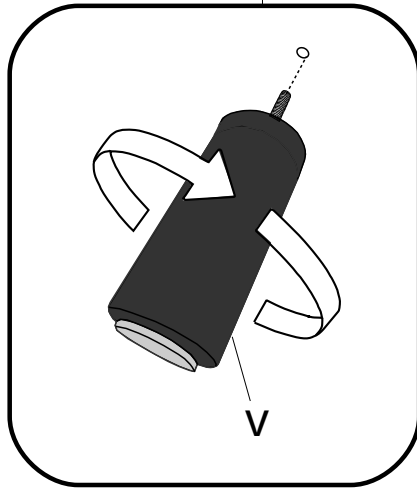
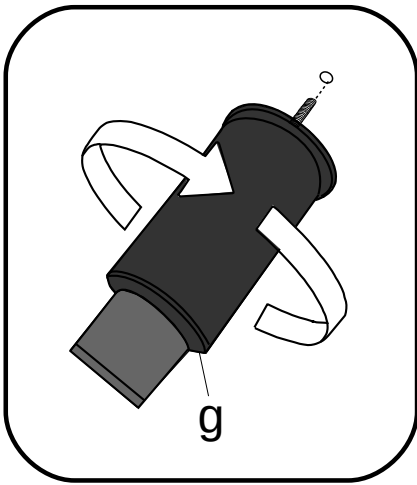
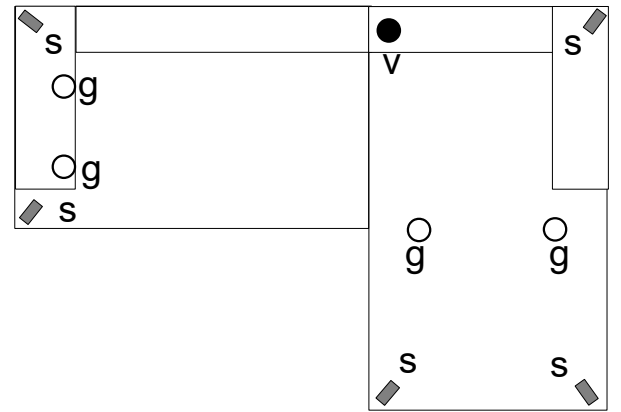
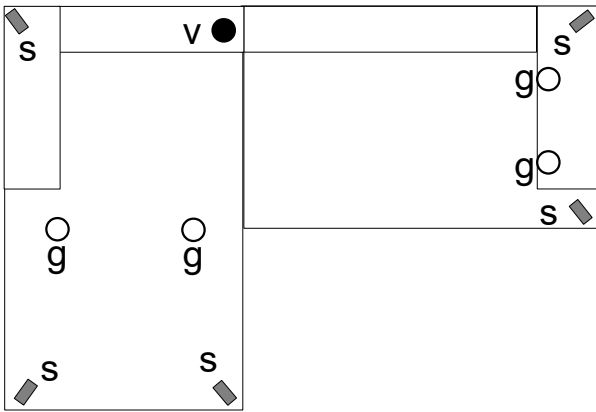
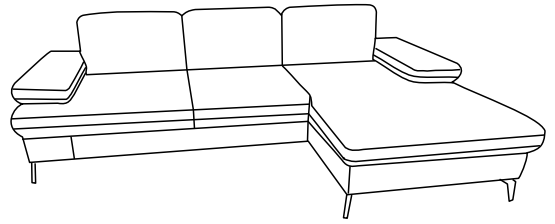
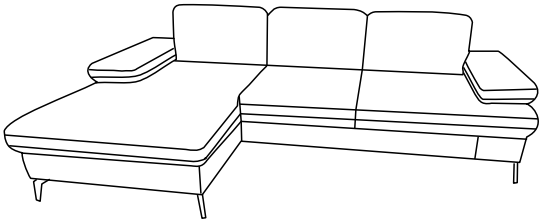

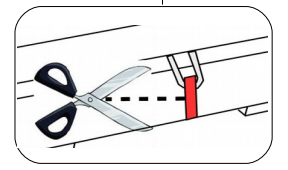
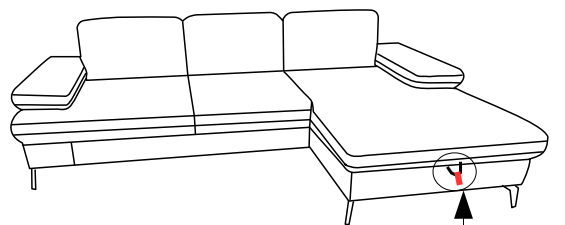
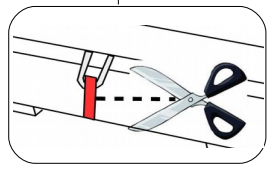
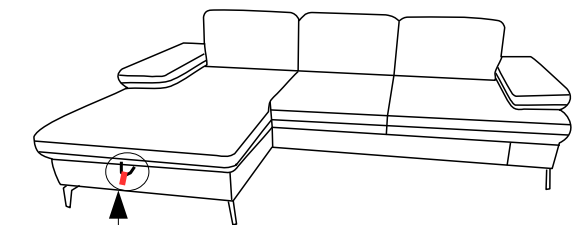
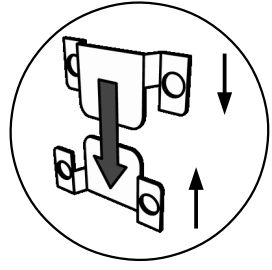
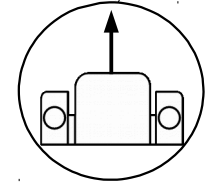
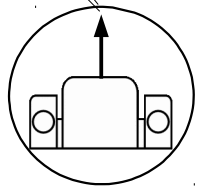
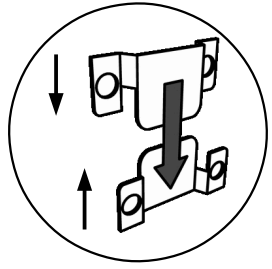
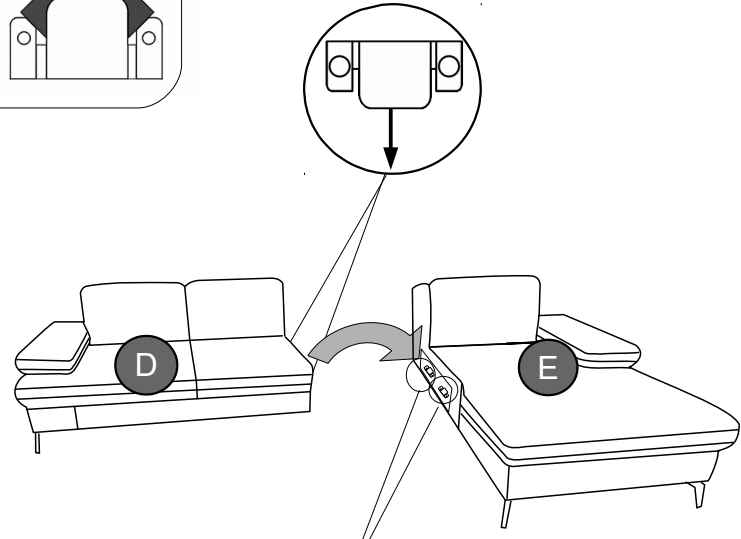
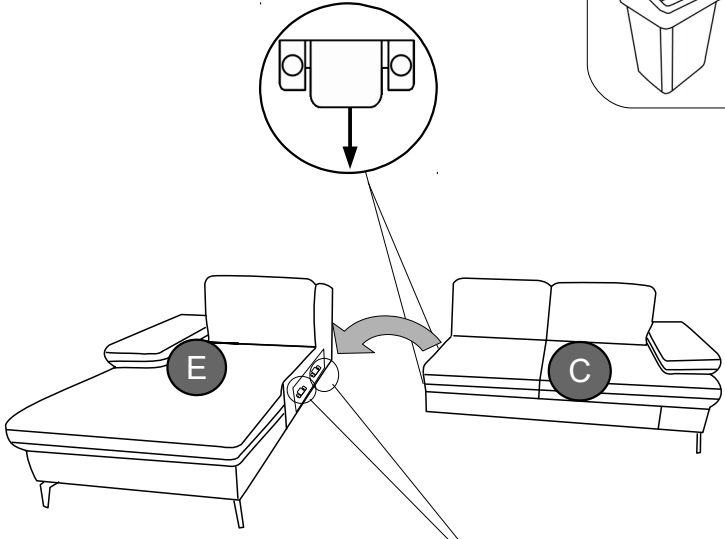
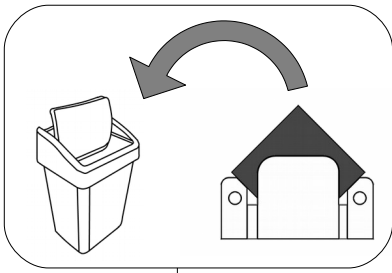



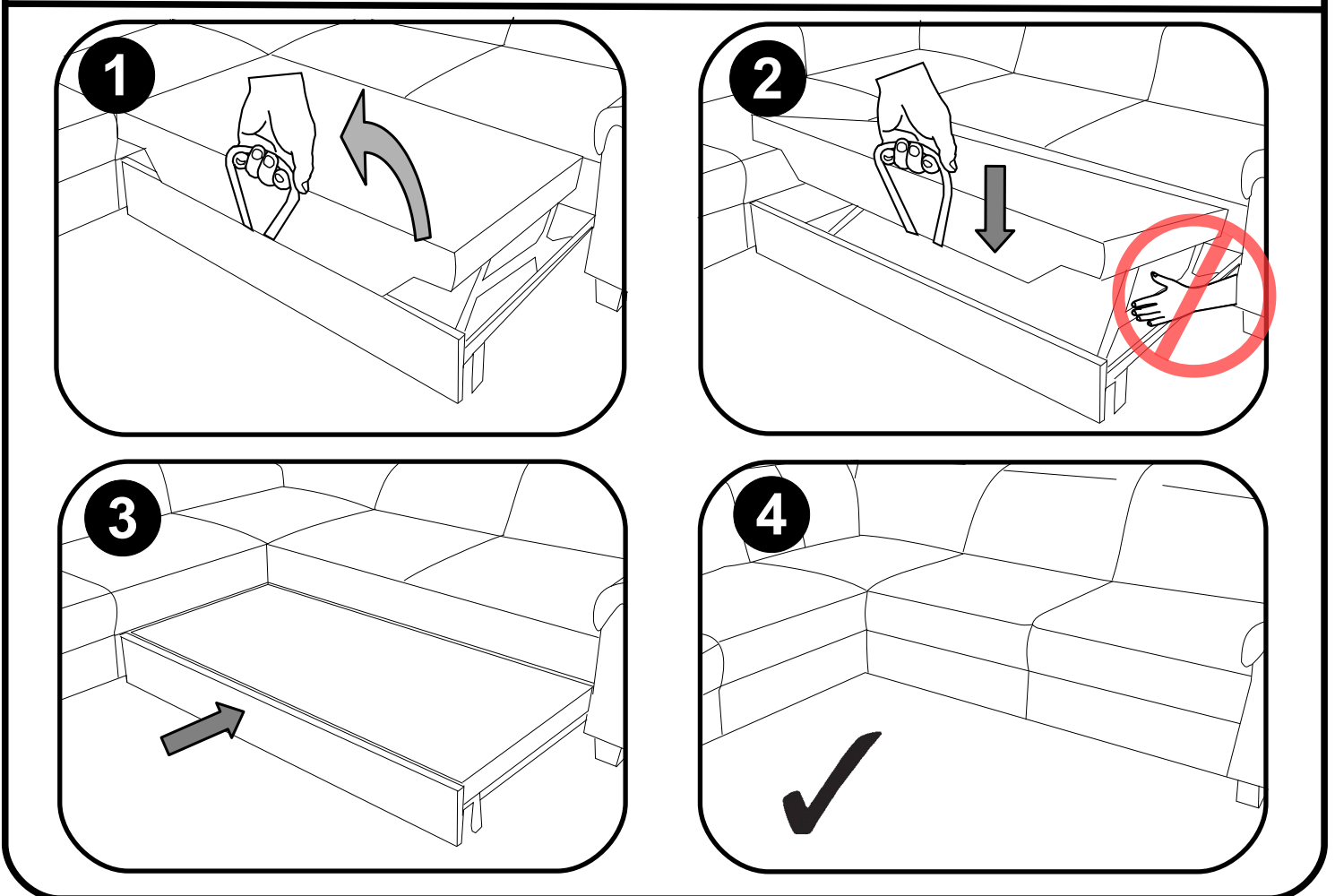
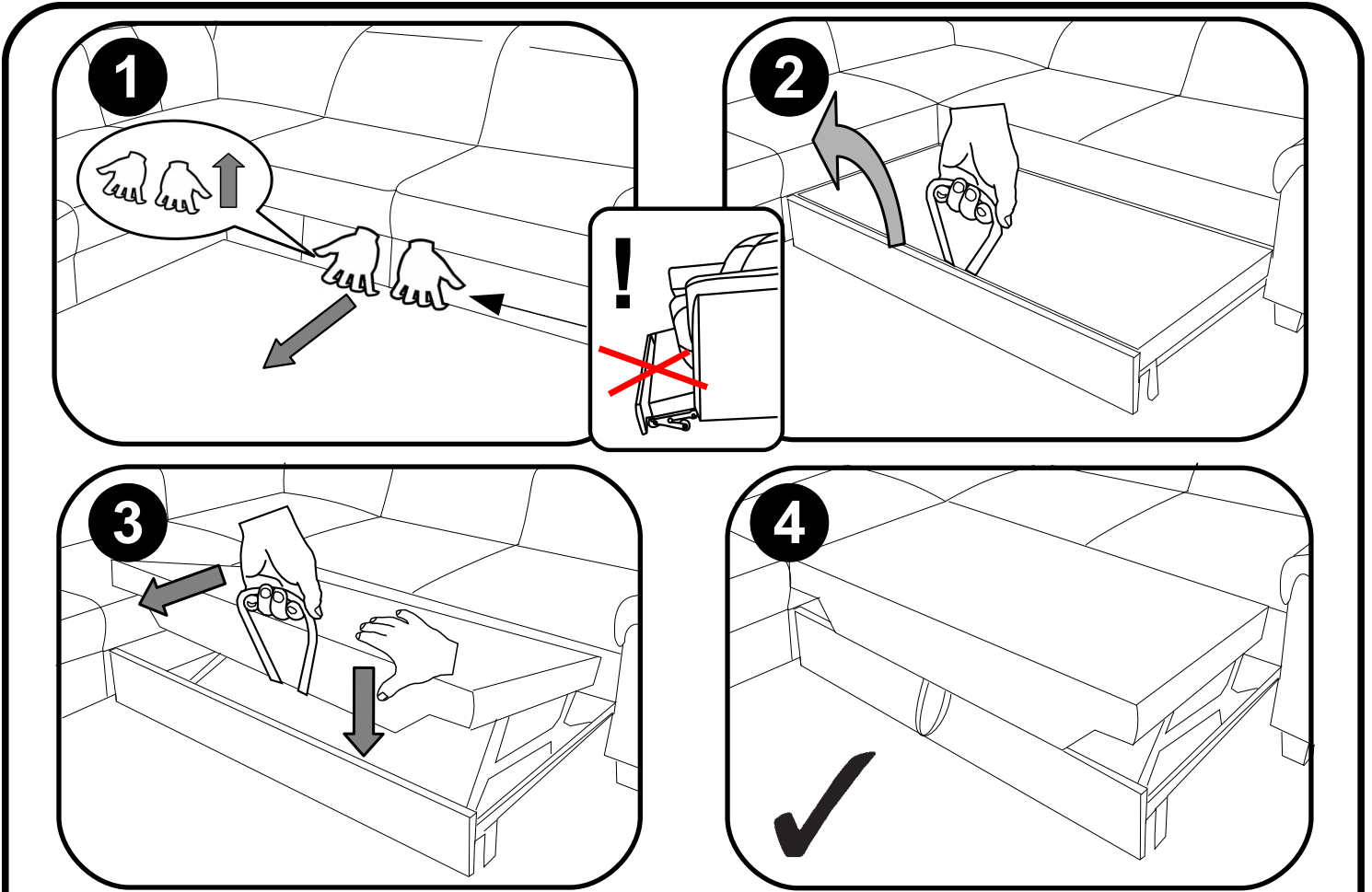
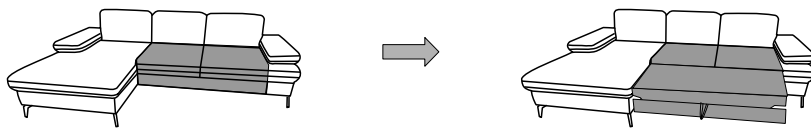

Service · Dienstverlening · Servis · Servis · Сервисная служба · Serviciu · Services · Servizio  
 ·Servisný list · Szolgáltatás · Servisní list

Name · Naam · Nazwa · İsim · Название · Nume · Nome · Názov · Názov ·  
 Název · Neve  
**MORRIS**  
 Тип · Type · Tip · Тип · Tipo · Típus

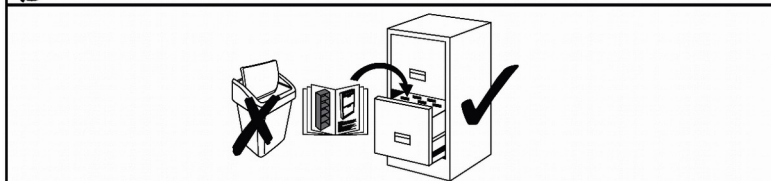
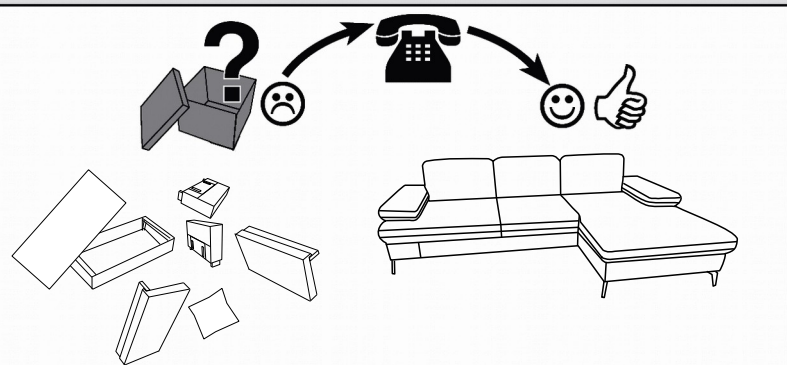

**L**

**R**

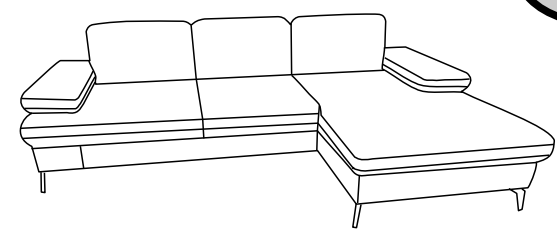
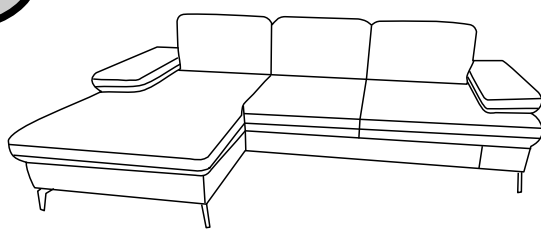
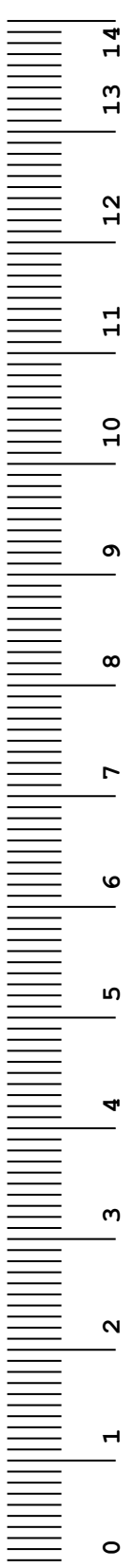

<b>g</b> H-120/150 	<b>v</b> H-120/150 	<b>S</b> H-120/150  S <sub>1</sub>	<b>q</b> M6*25 [mm] 
------------------------	------------------------	--	-------------------------

