

WH400 0800/0900/1000 (L/R)

Achtung! Gläser niemals ungeschützt auf den Boden stellen.
Verletzung der Glaskante führt zu Glasbruch.

Caution! Never put glass walls on the floor without protection.
Damaging the glass edges results in breaking of the glass.

Attention! Jamais placer des parois de douche en verre au sol sans protection. Des verres endommagés casseront.

Mögliche Einsatzgebiete des Elements WH400:

(MAL = Montageanleitung)

Nische, WH400+WHAN1928



Fronteinstieg, WH400+WH001

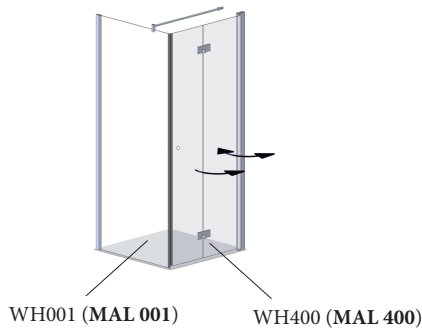

Eckeneinstieg, 2x WH400

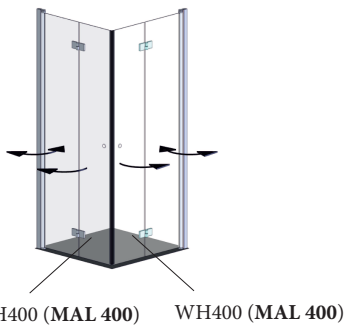

Die abgebildeten Formen der Profile und Griffe dienen der schematischen Darstellung und entsprechen nicht dem tatsächlichen Lieferumfang!

CE

Mitgeliefertes Montagematerial
supplied assembly material
matériaux pour assemblage

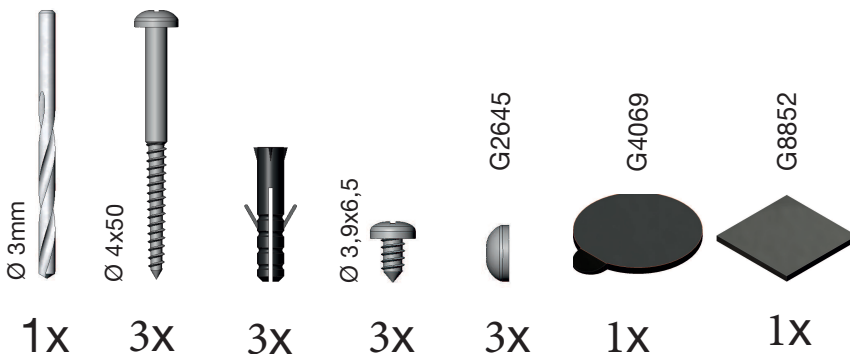

Zum Aufbau benötigen Sie
for mounting you need
pour l'installation il vous faut



5 Jahre
Garantie

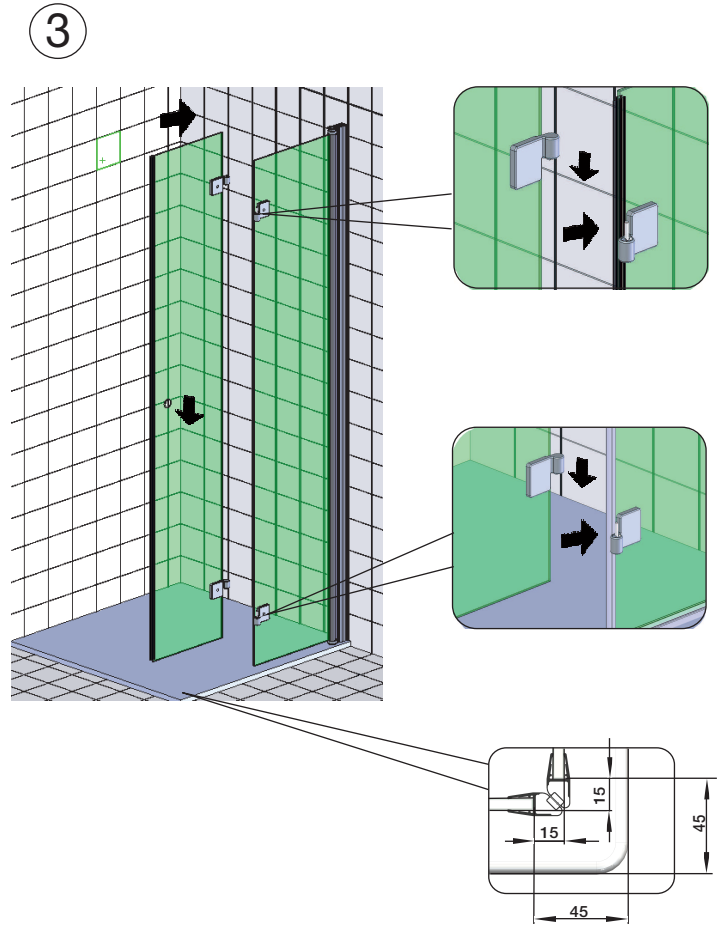
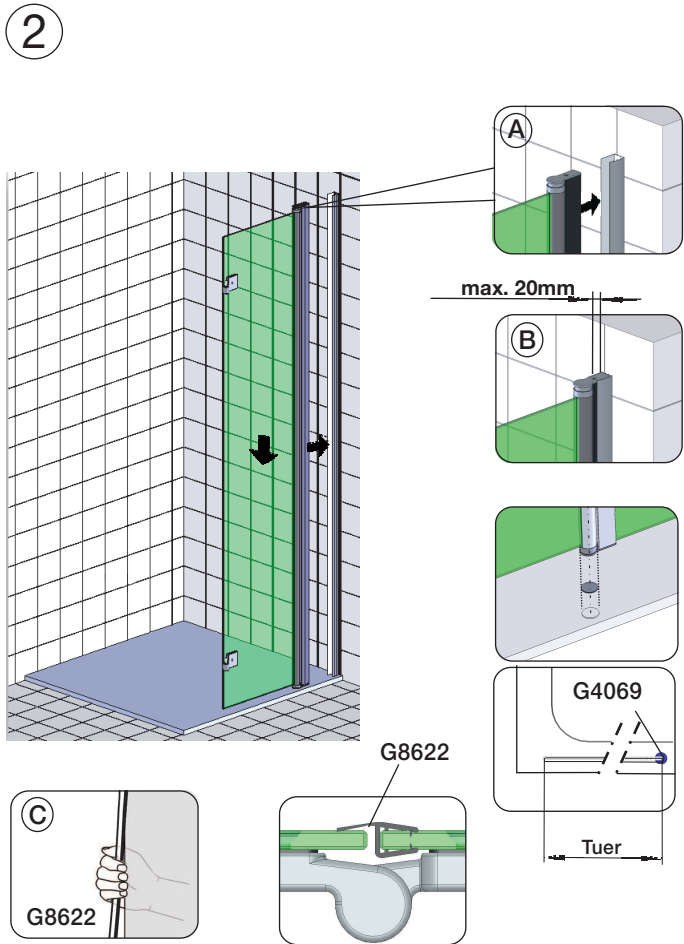
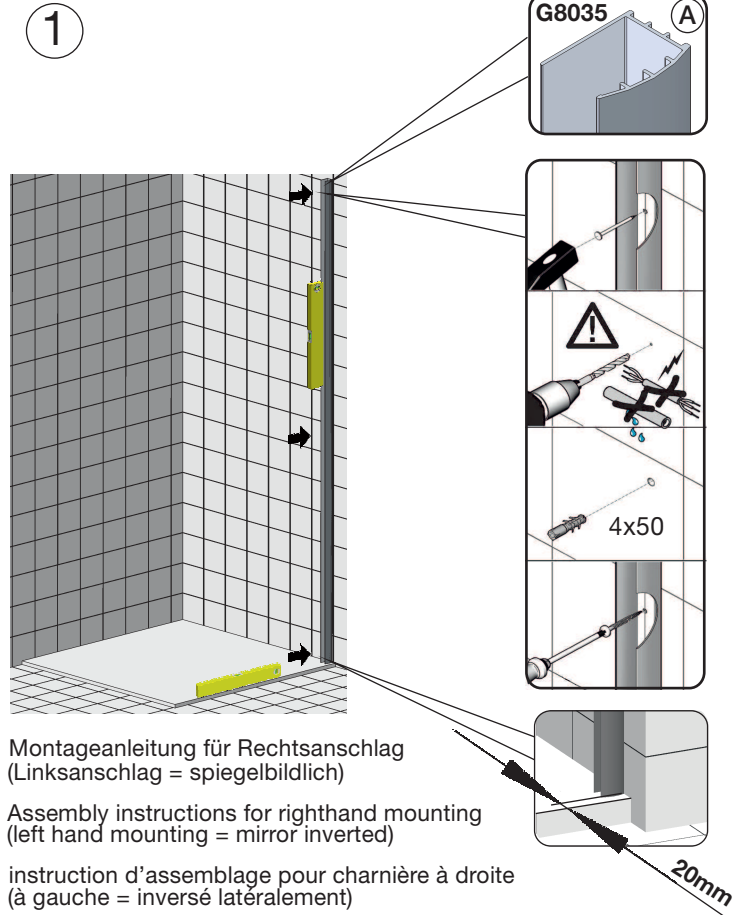
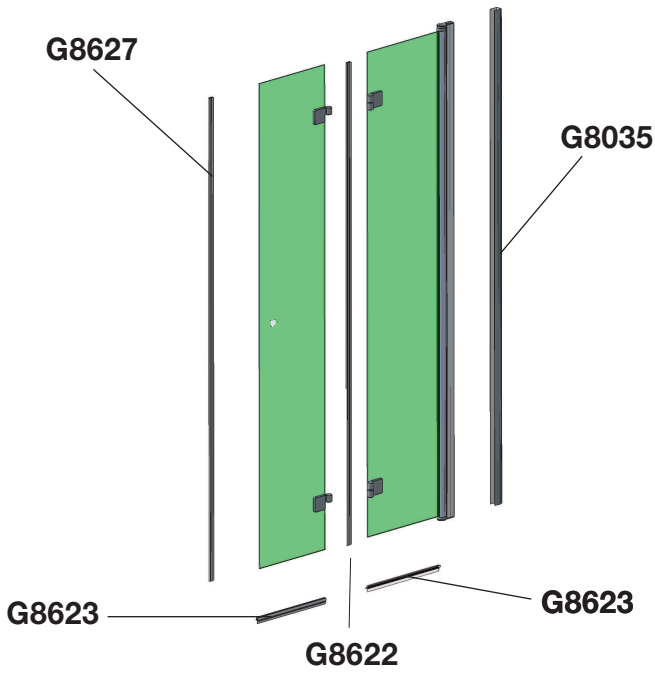

4

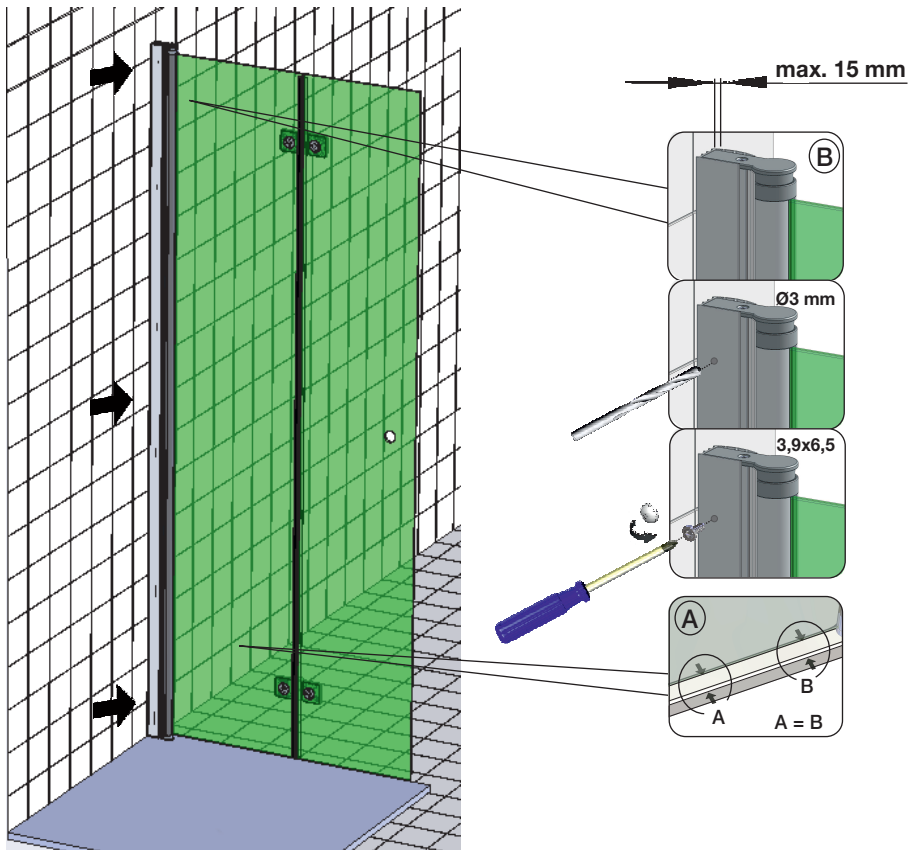

5

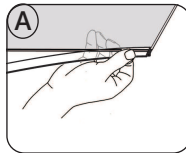
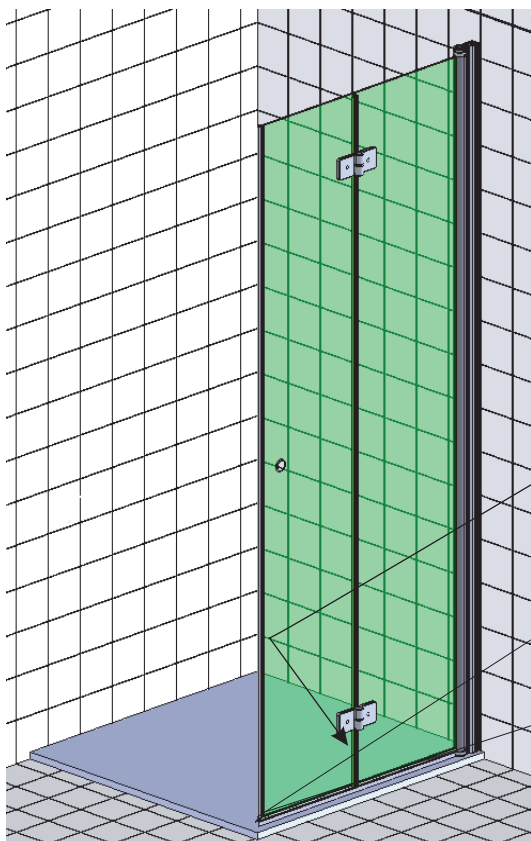

G8623

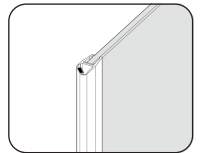
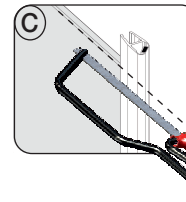
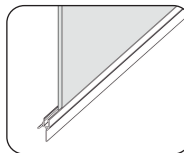

G8627

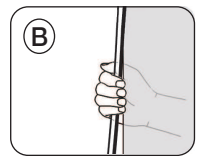

G8627

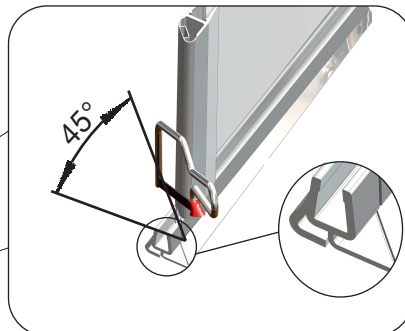

6

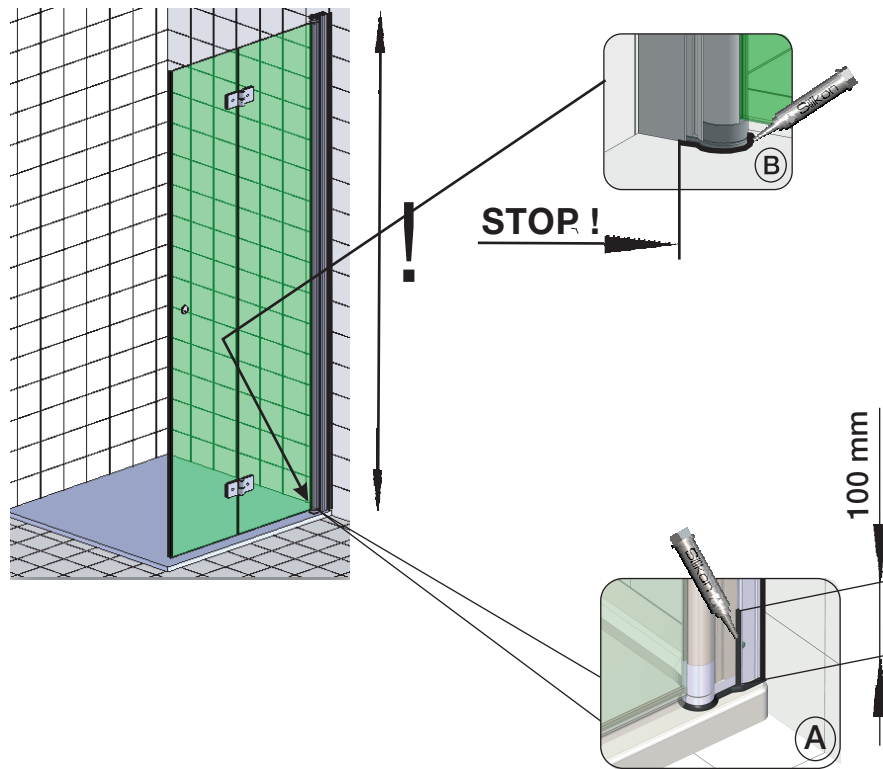

Nischenmontage / MOUNTING WALL TO WALL

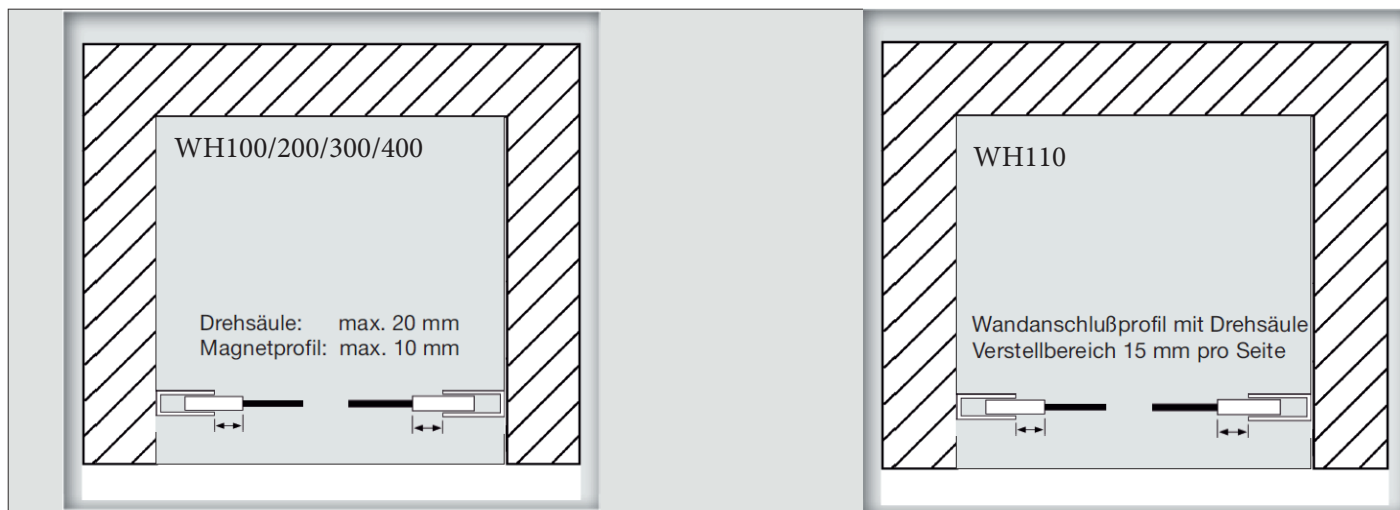

Montage Fronteinstieg mit Seitenteil / Eckeinstieg / MOUNTING FRONT ENTRY/CORNER ENTRY

Montage auf Duschtasse

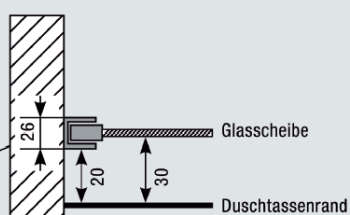
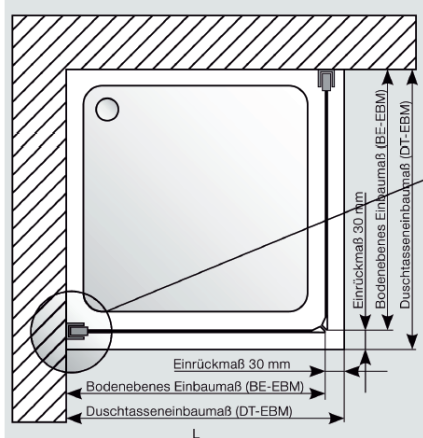

DT	DT-EBM	BE-EBM
800	785-805	755-775
900	885-905	855-875
1000	985-1005	955-975
1200	1185-1205	1155-1175
1400	1385-1405	1355-1375

Montage Bodeneben

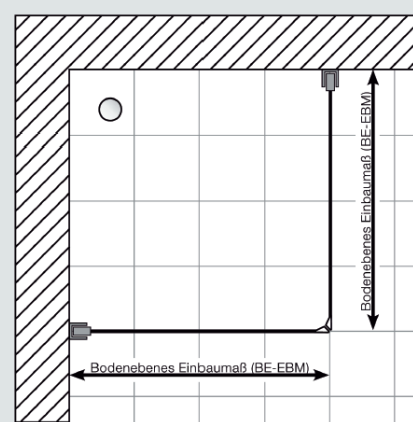

Detail WH110 mit WHFST / DETAIL WH110 with WHFST

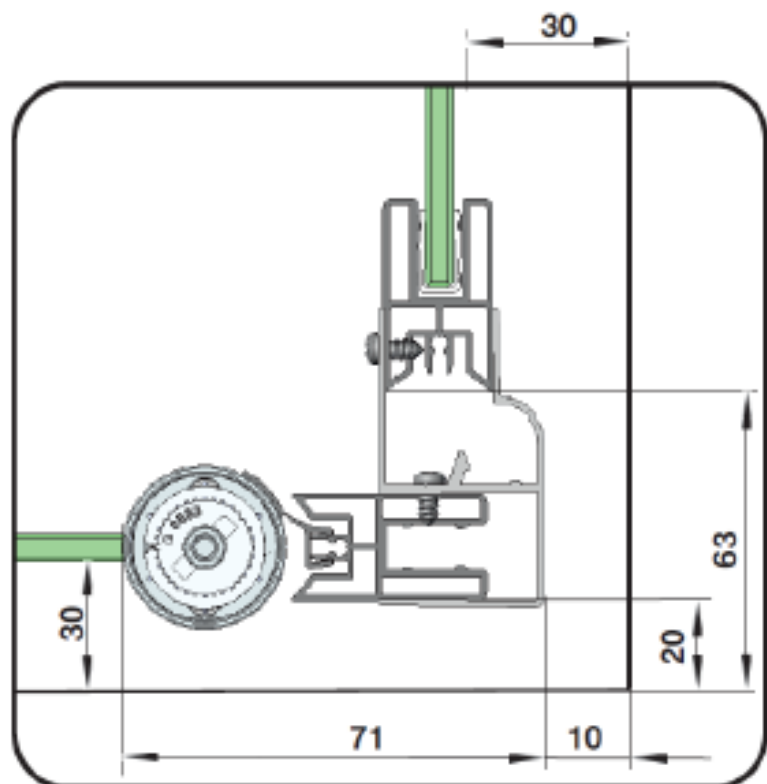

EG-Konformitätserklärung
EC Declaration of Conformity

Hersteller/ Name und Adresse: GEO Produkte GmbH
Manufacturer/ name and address: Friedrichsfelder Straße 27
68723 Schwetzingen

Wir erklären in alleiniger Verantwortung:
We declare under our sole responsibility:

Produktbenennung: Duschabtrennung mit ESG
oder Kunststoffglas
product designation: shower enclosure with
tempered glass and acrylic-glass

Typ / Modell: alle Modelle
type / model: all models

stehen in Übereinstimmung mit den Bestimmungen der im Folgenden
genannten Richtlinie und Standards:
*are in conformity with the provisions of the following regulations and
standards:*

EN 14428:2004 + A1:2008



GEO Produkte GmbH
Friedrichsfelder Straße 27
68723 Schwetzingen /Germany
Tel. +49(0)6202 20930
FAX +49(0)6202 209399

13

DE2013/01

www.geoprodukte.com/service/leistungserklärung.html/

EN 14428

Duschabtrennung mit Einscheiben Sicherheitsglas oder Kunststoffglas
Shower wall made of *ESG tempered safety glass or sythetic glass*

Reinigbarkeit:
cleanability: Bestanden
passed

Bruch Eigenschaften:
impact resistance: Bestanden
passed

Dauerhaftigkeit:
durability: Bestanden
passed