







<p>A</p>  <p>120PCS</p>	<p>B</p>  <p>120PCS</p>	<p>C</p>  <p>30PCS</p>	<p>D</p>  <p>16PCS</p>
<p>E</p>  <p>2SET</p>	<p>F</p>  <p>9PCS</p>		



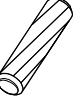

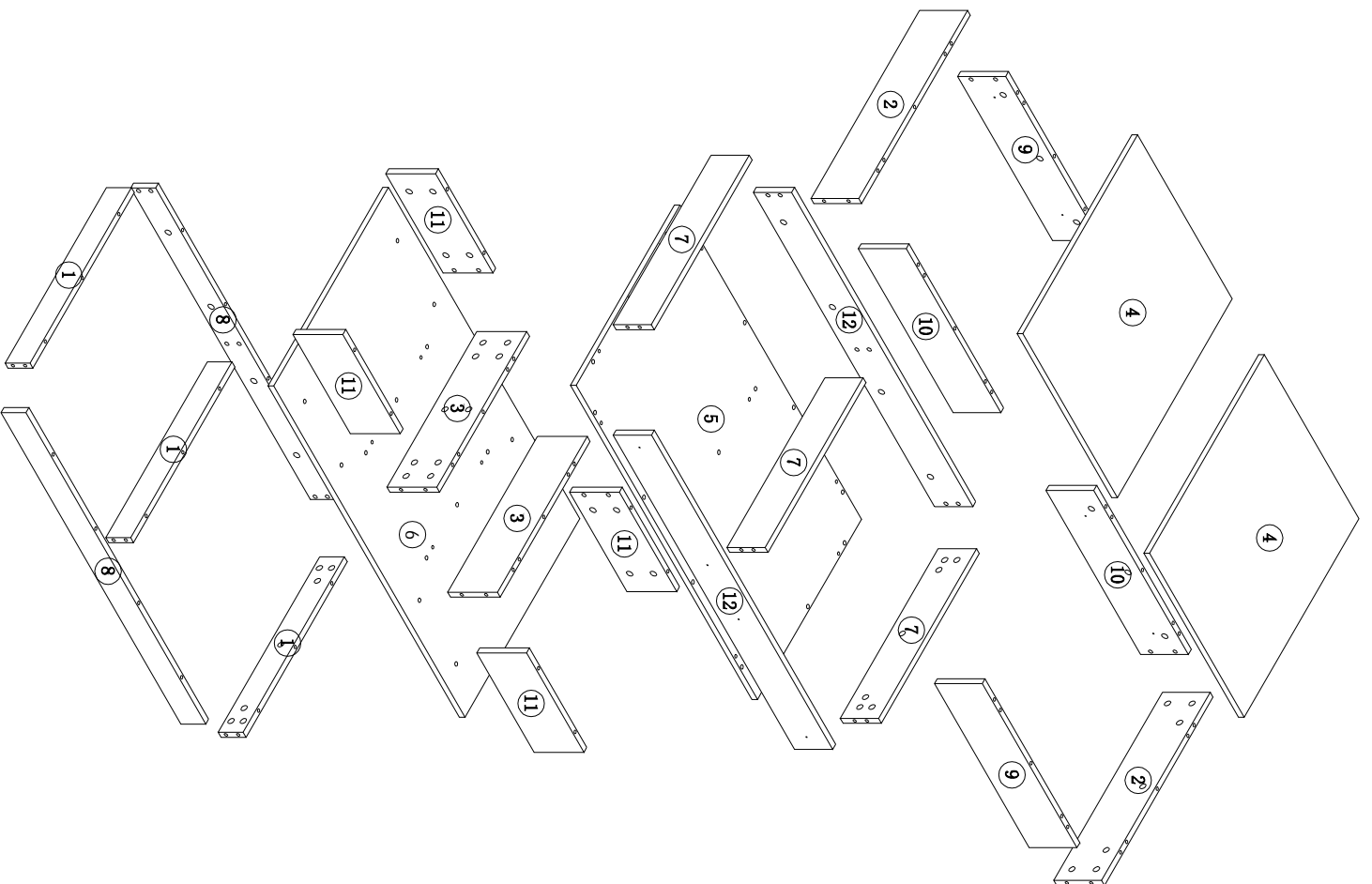
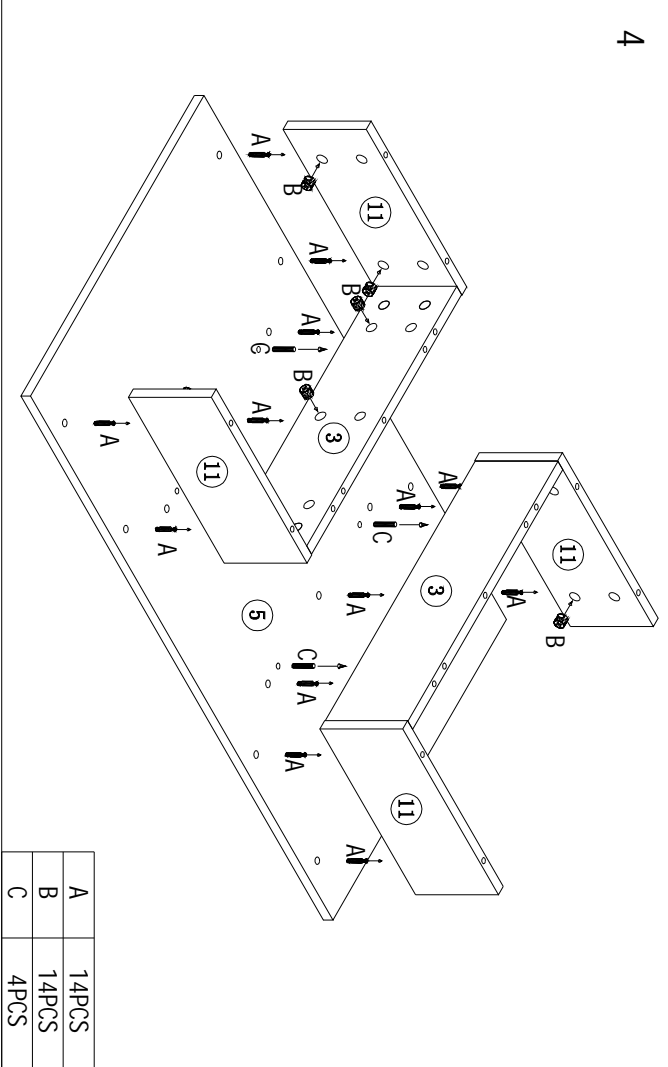
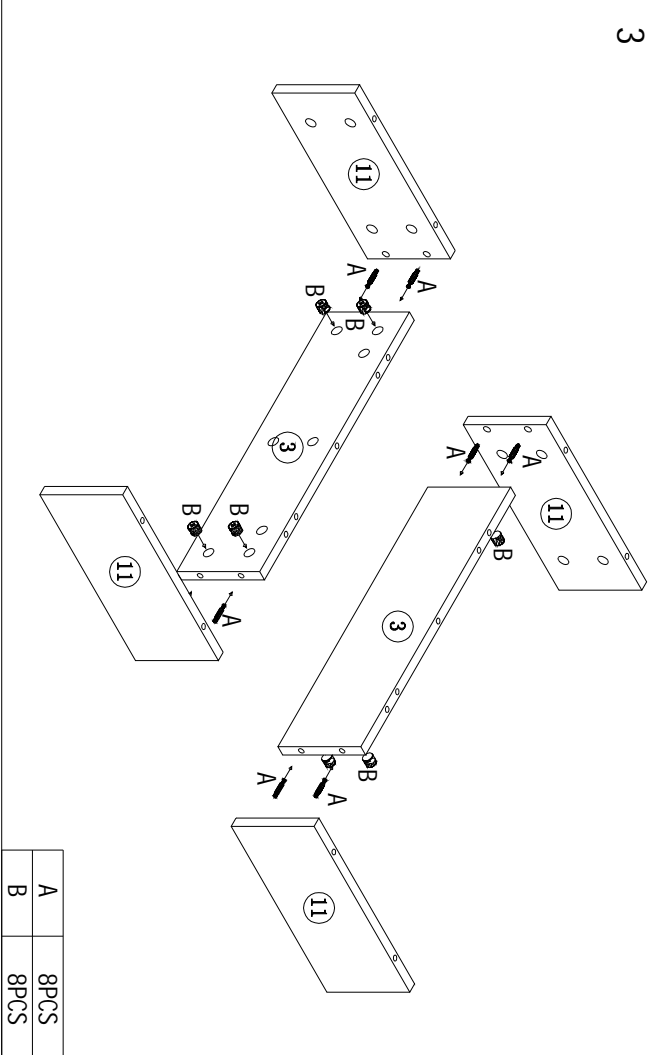
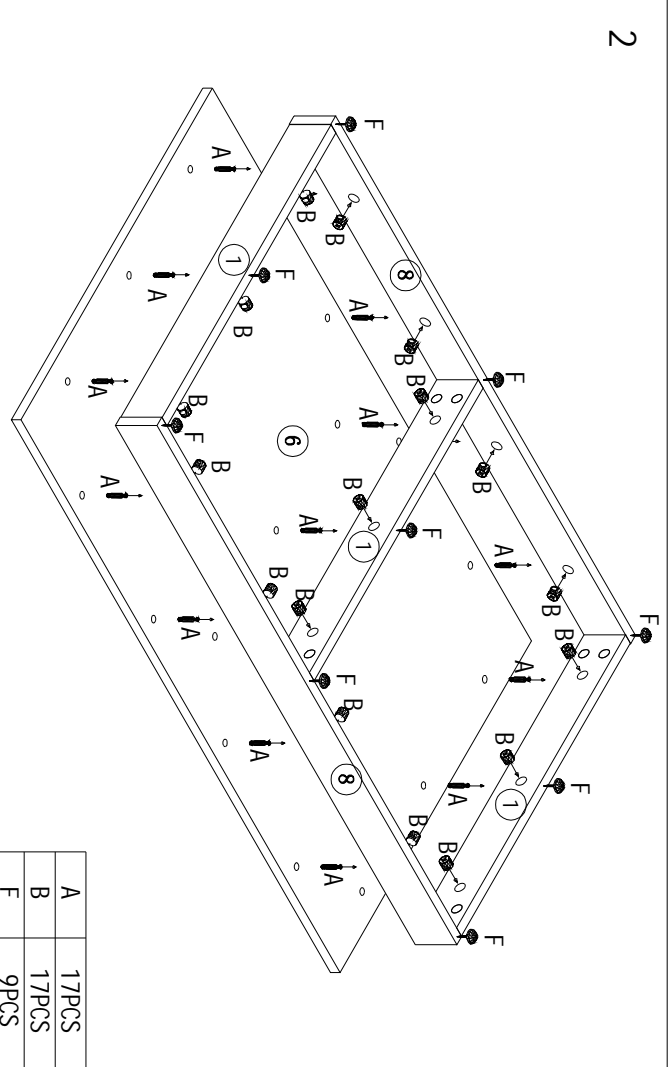
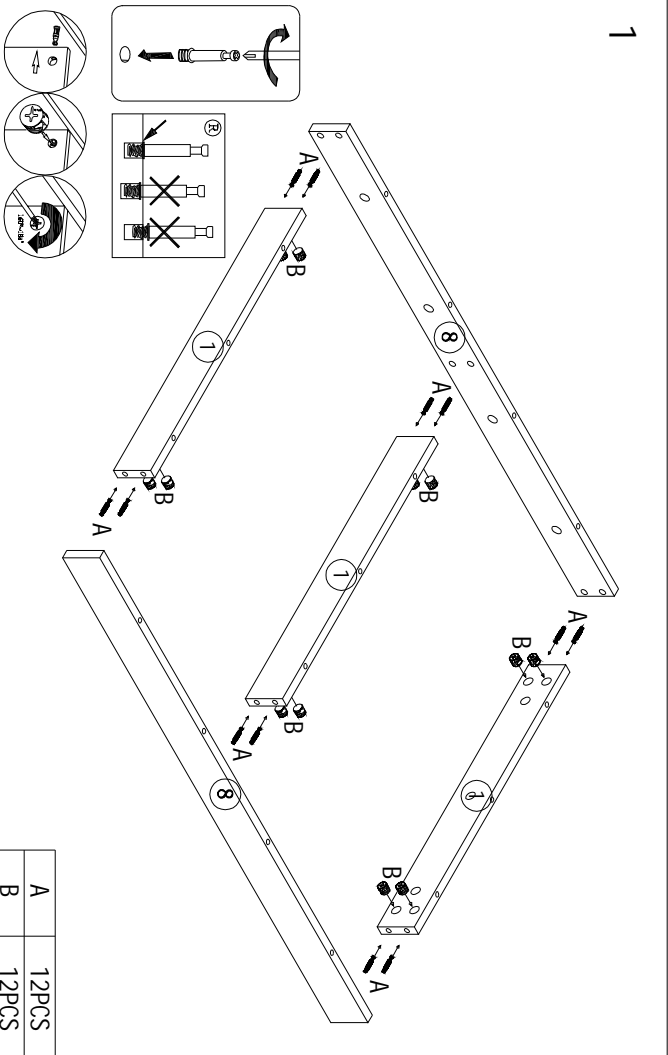
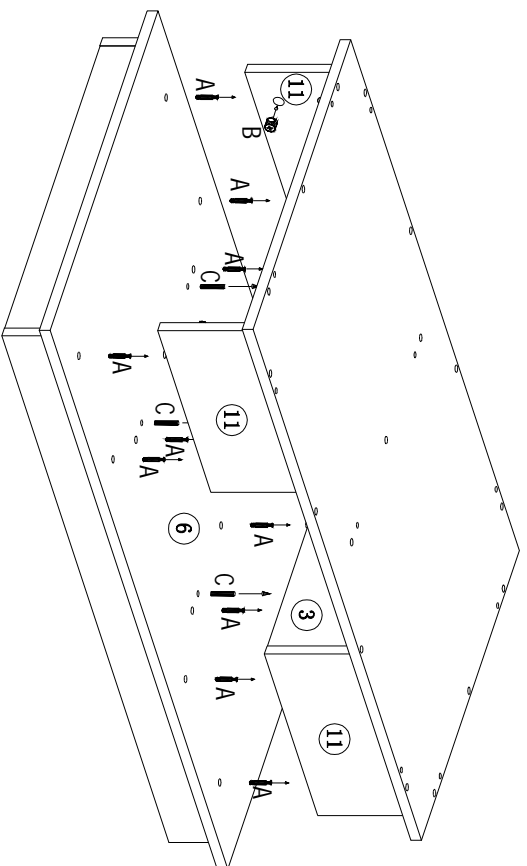

A	14PCS
B	14PCS
C	4PCS

5

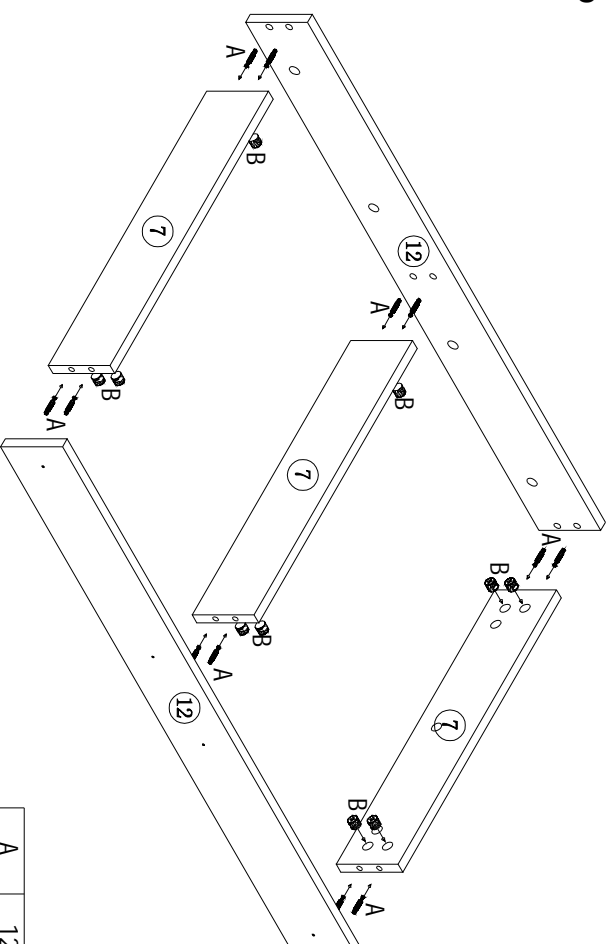

A	12PCS
B	12PCS

6

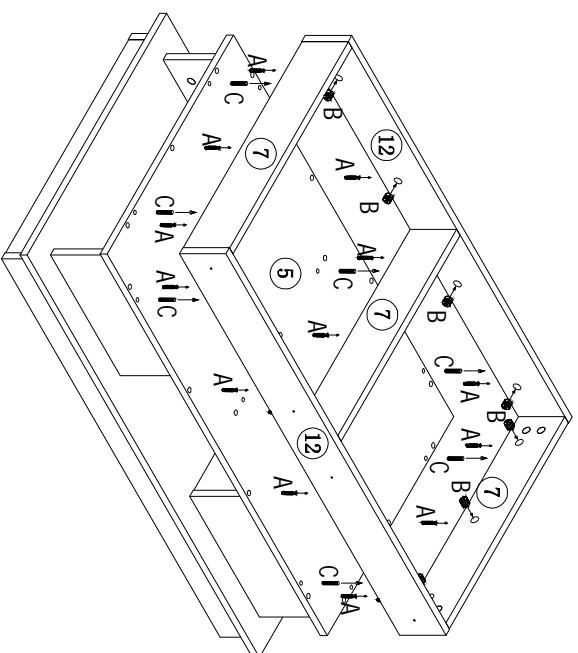

A	17PCS
B	17PCS
C	10PCS

7

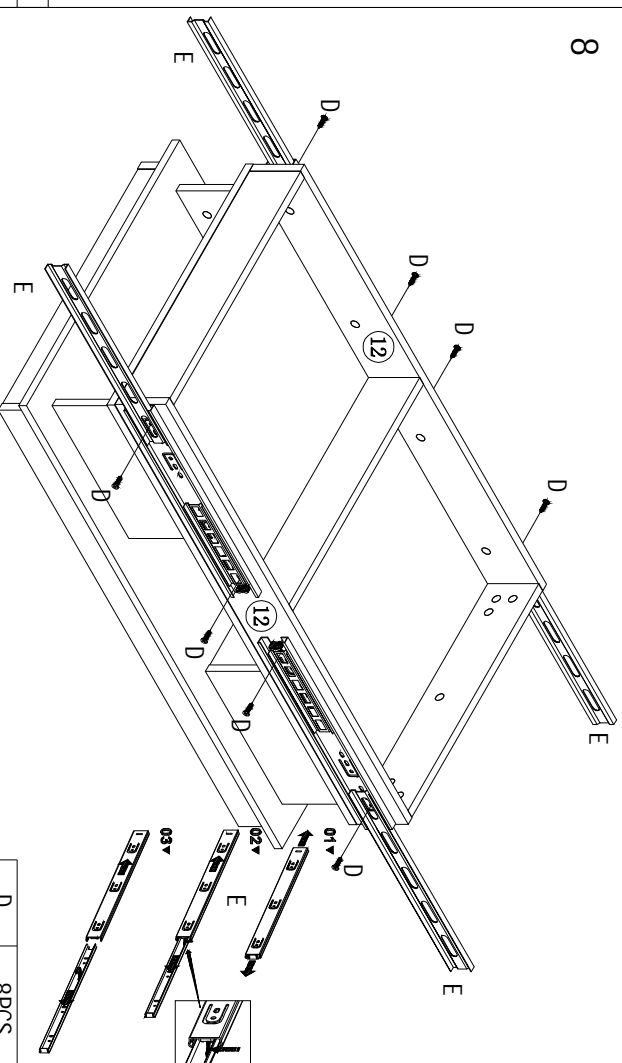

D	8PCS
E	4PCS

8

9

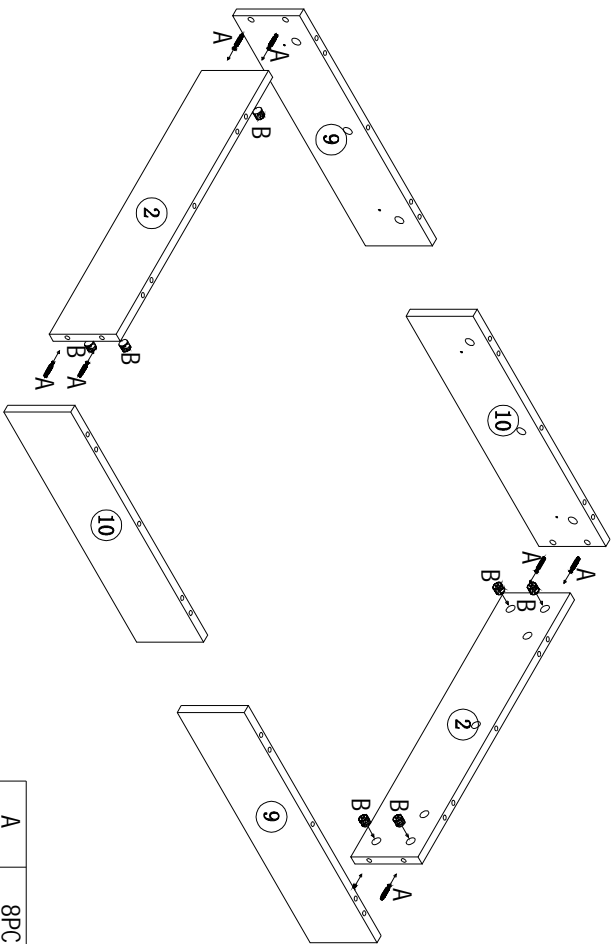

A	8PCS
B	8PCS

10

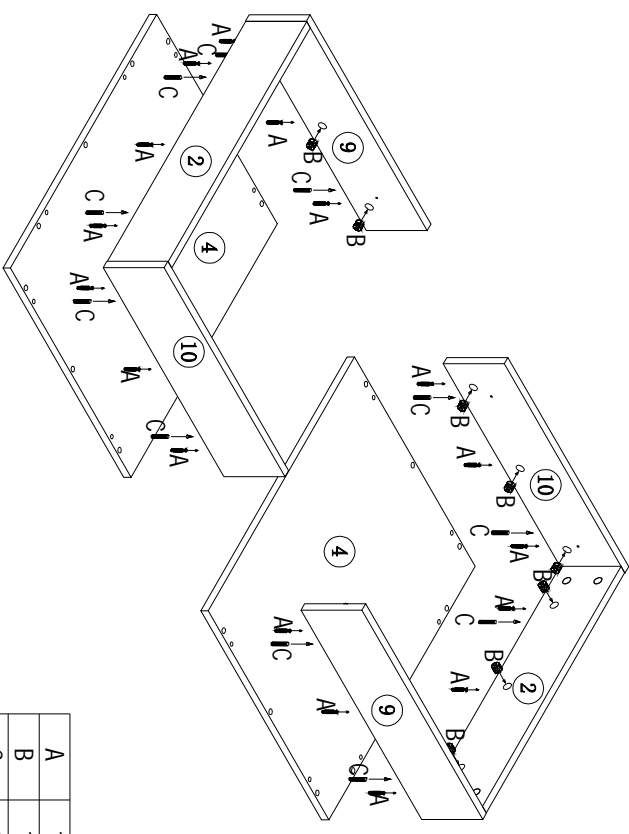

A	18PCS
B	18PCS
C	12PCS

11

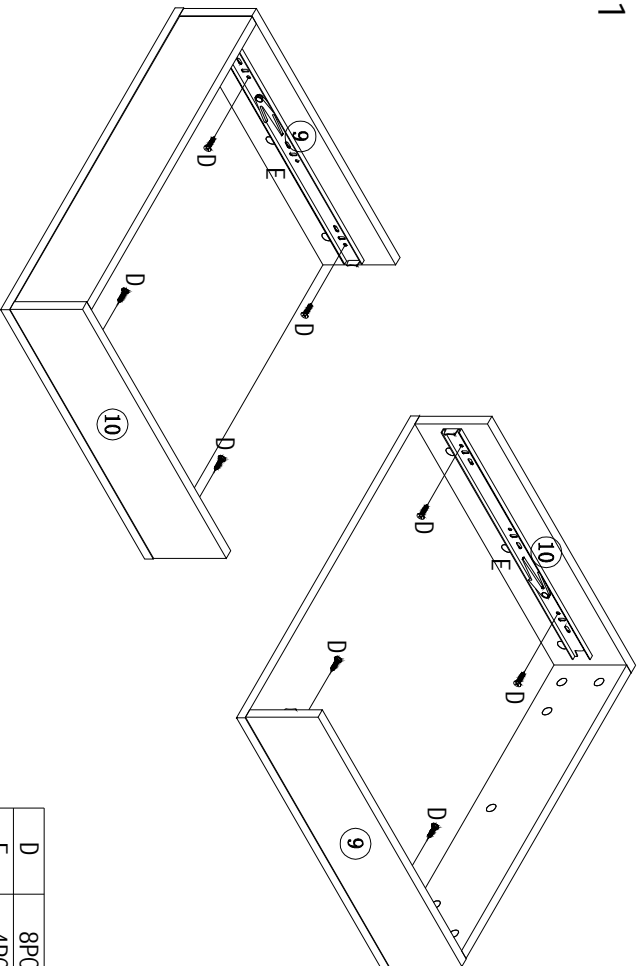

D	8PCS
E	4PCS

12

