

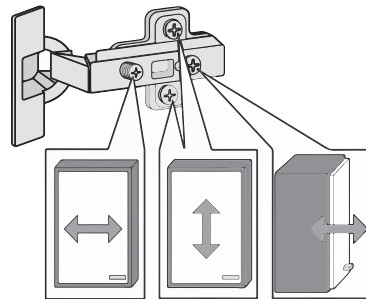

87243.530

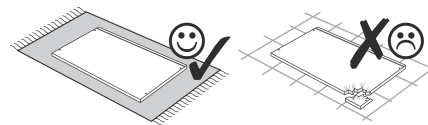

1 8 x 2827	2 8 x	3 8 x 30 24 x 2861	4 Leim 1 x 2863	5 5 x 1503
6 5 x 1611	7 3,5 x 15 14 x 2804	8 2 x	9 4 x	10 5mm 4 x 2855
11 4 x 2865	12 2 x 2527	13 4 x 45 2 x 2814	14 6 x 34 2 x 2844	15 4 x 9 5 x 30 2 x 1 x
16 2 x 2532	17 1 x 4940			

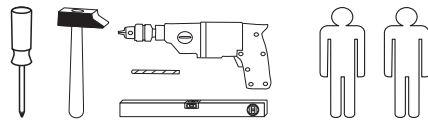
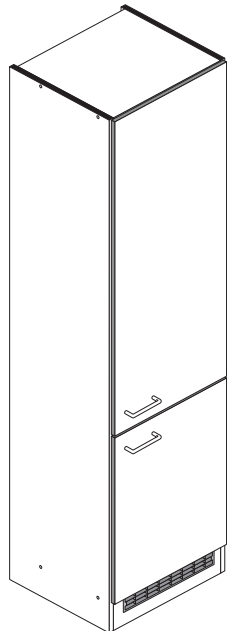
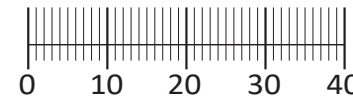

Das beigefügte Wandbefestigungsmaterial (Dübel und Schrauben) eignet sich nur für festes Mauerwerk (z.B.: Beton- oder Ziegelwände). Für andere Wandaufbauten sind eventuell Spezialdübel und andere Schrauben notwendig. Ziehen Sie gegebenenfalls eine Fachkraft zu Rate.

De begeleidende wandmontage hardware (pluggen en schroeven) is alleen geschikt voor massief metselwerk (bijvoorbeeld beton of bakstenen muren). Voor andere muur structuren zijn eventueel bijzondere ankerbouten en andere noodzakelijke. Draai indien nodig, een deskundige.

Приложенный материал для крепления к стене (дюбели и винты) пригоден только для жестких кладок (например, бетонные или кирпичные стены). Для других настенных конструкций необходимы смотря по обстоятельствам специальные дюбели и другие винты. При необходимости проконсультируйтесь у специалиста.

Le mur d'accompagnement matériel de montage (chevilles et les vis) è'e adatto solo per muratura piena (ad esempio calcestruzzo o muratura). Per le altre strutture murarie sono forse speciali bulloni di ancoraggio e necessari di altri. Serrare se necessario, un esperto.

Załączony materiał do mocowania do ściany (kolki rozprężne i wkręty) nadaje się tylko do ścian murowanych (np. z betonu lub cegiel). Do ścian wykonanych w innych technologiach konieczne być mogą specjalne kolki rozprężne i inne wkręty. W razie potrzeby skorzystaj z fachowej pomocy

Il muro di accompagnamento hardware di montaggio (tasselli e viti) è'e adatto solo per muratura piena (ad esempio calcestruzzo o muratura). Per le altre strutture murarie sono forse speciali bulloni di ancoraggio e necessari di altri. Serrare se necessario, un esperto.

The accompanying wall mounting hardware (anchors and screws) is suitable only for solid masonry (eg concrete or brick walls). For other wall structures are possibly special anchor bolts and other necessary. Tighten if necessary, an expert.

Ekteki duvarar sabit montaj malzemeleri (dübel ve vidalar), sadece sağlam duvarlar için (örnek: beton veya tuğla) elverişlidir. Başka duvarlar için özel dübeller ve farklı vidalar gerekebilir. Gerektiğinde bir uzmana danışınız.

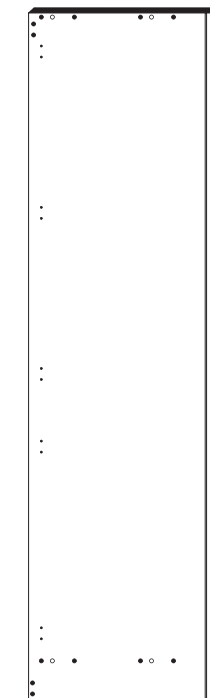

20 1 x

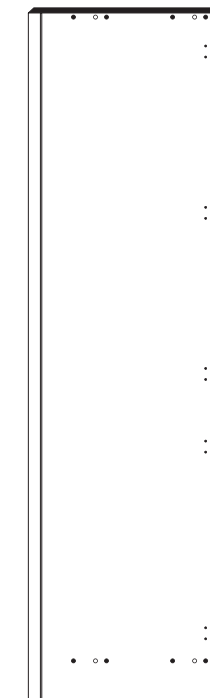

21 1 x

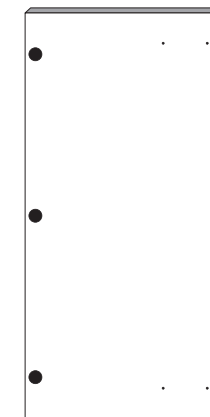

22 1 x

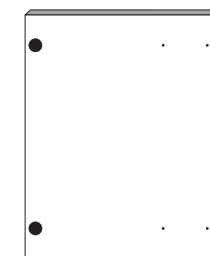

23 1 x

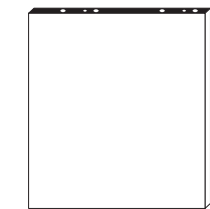

24 2 x



25 1 x

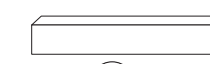

26 1 x

1

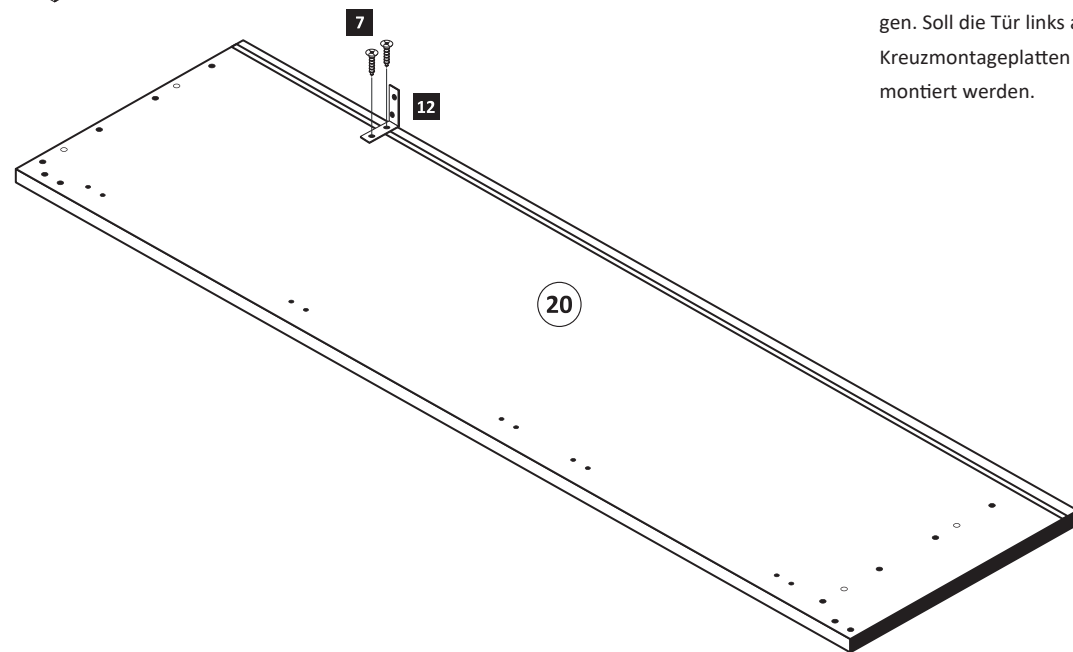
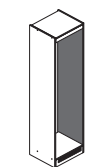

6 5 x 1611	7 3,5 x 15 4 x 2804	12 2 x 2527
---------------	---------------------------	----------------

Bitte beachten !
In dieser Aufbauanleitung ist die Tür rechts angeschlagen. Soll die Tür links angeschlagen werden, müssen die Kreuzmontageplatten 6 auf das linke Seitenteil 20 montiert werden.

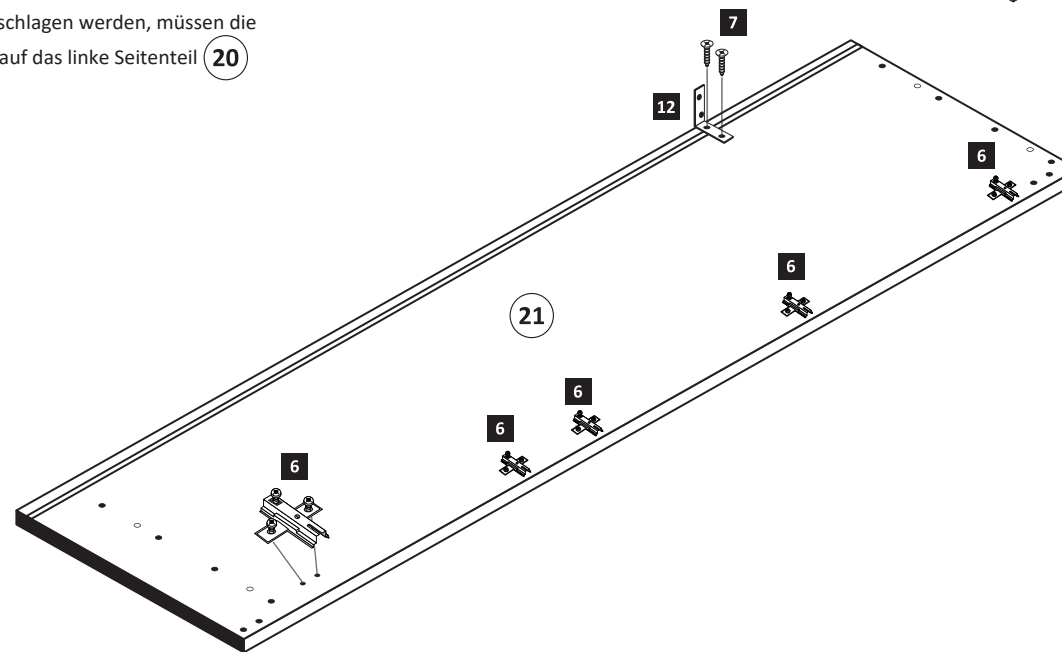

2

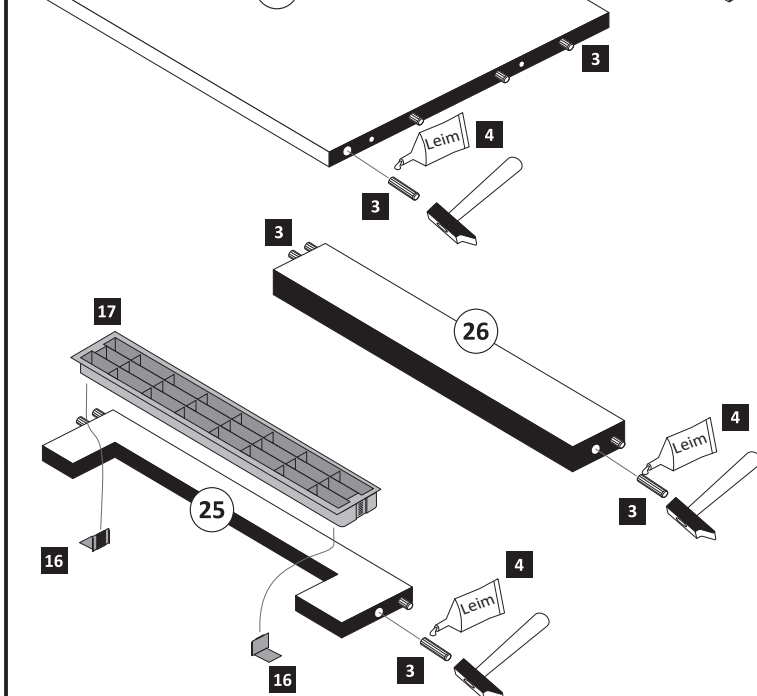

3 8 x 30 24 x 2861	4 Leim 1 x 2863	16 2 x 2532	17 1 x 4940
--------------------------	-----------------------	----------------	----------------

3

1 8 x 2827 2 8 x

4 Leim

24 26 21 20 25

1 2 1 2 1 2 1 2

Leim

24 25

1 2 1 2

4 Leim

1 x 2863

20 min.

D Leim
GB Glue
NL Lijm
PL Klej
TR Tutkal
F Colle
I Colla

5

5 3 x 1503 7 3,5 x 15 11 6 x 2804 2 x 2865

22 11

2. $\varnothing 5\text{ mm}$

1.

ACHTUNG !
Montagebeispiel Rechtsanschlag
Bei Linksanschlag andere
Griffbohrungen durch bohren !

4

5 2 x 1503 7 3,5 x 15 11 4 x 2804 2 x 2865

23 11

2. $\varnothing 5\text{ mm}$

1.

ACHTUNG !
Montagebeispiel Rechtsanschlag
Bei Linksanschlag andere
Griffbohrungen durch bohren !

6

8 2 x 9 4 x 5mm 4 x 2855

22 23 8 8

10 9 9

7

13 4 x 45 2 x 2814 14 6 x 34 2 x 2844

20 21 12 13 14

8

15 4 x 9 5 x 30 2 x 1 x

a b

1. 2. $\varnothing 5\text{ mm}$

15



87243.530

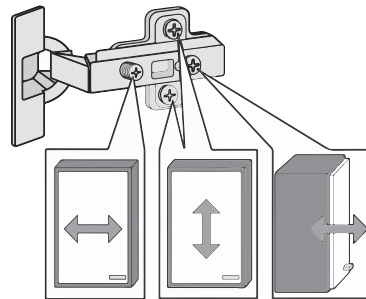
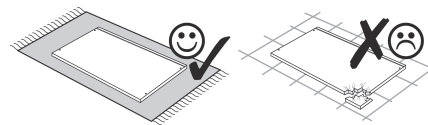
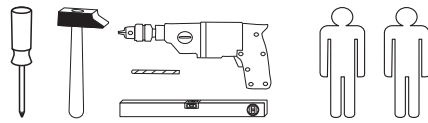
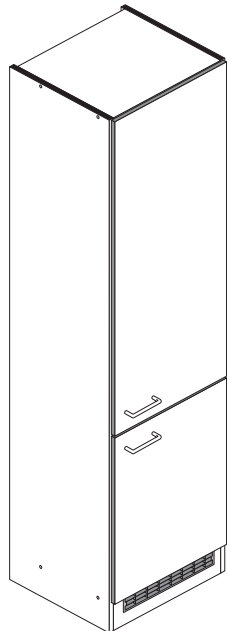

1 8 x 2827	2 8 x	3 8 x 30 24 x 2861	4 Leim 1 x 2863	5 5 x 1503
6 5 x 1611	7 3,5 x 15 14 x 2804	8 2 x	9 4 x	10 5mm 4 x 2855
11 4 x 2865	12 2 x 2527	13 4 x 45 2 x 2814	14 6 x 34 2 x 2844	15 4 x 9 5 x 30 2 x 1 x
16 2 x 2532	17 1 x 4940			

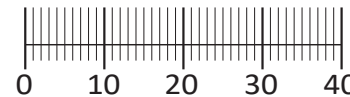

Das beigefügte Wandbefestigungsmaterial (Dübel und Schrauben) eignet sich nur für festes Mauerwerk (z.B.: Beton- oder Ziegelwände). Für andere Wandaufbauten sind eventuell Spezialdübel und andere Schrauben notwendig. Ziehen Sie gegebenenfalls eine Fachkraft zu Rate.

De begeleidende wandmontage hardware (pluggen en schroeven) is alleen geschikt voor massief metselwerk (bijvoorbeeld beton of bakstenen muren). Voor andere muur structuren zijn eventueel bijzondere ankerbouten en andere noodzakelijke. Draai indien nodig, een deskundige.

Приложенный материал для крепления к стене (дюбели и винты) пригоден только для жестких кладок (например, бетонные или кирпичные стены). Для других настенных конструкций необходимы смотря по обстоятельствам специальные дюбели и другие винты. При необходимости проконсультируйтесь у специалиста.

Le mur d'accompagnement matériel de montage (chevilles et les vis) è'e adatto solo per muratura piena (ad esempio calcestruzzo o muratura). Per le altre strutture murarie sono forse speciali bulloni di ancoraggio e necessari di altri. Serrare se necessario, un esperto.

Załączony materiał do mocowania do ściany (kolki rozprężne i wkręty) nadaje się tylko do ścian murowanych (np. z betonu lub cegiel). Do ścian wykonanych w innych technologiach konieczne być mogą specjalne kolki rozprężne i inne wkręty. W razie potrzeby skorzystaj z fachowej pomocy

Il muro di accompagnamento hardware di montaggio (tasselli e viti) è'e adatto solo per muratura piena (ad esempio calcestruzzo o muratura). Per le altre strutture murarie sono forse speciali bulloni di ancoraggio e necessari di altri. Serrare se necessario, un esperto.

The accompanying wall mounting hardware (anchors and screws) is suitable only for solid masonry (eg concrete or brick walls). For other wall structures are possibly special anchor bolts and other necessary. Tighten if necessary, an expert.

Ekteki duvara sabit montaj malzemeleri (dübel ve vidalar), sadece sağlam duvarlar için (örnek: beton veya tuğla) elverişlidir. Başka duvarlar için özel dübeller ve farklı vidalar gerekebilir. Gerektiğinde bir uzmana danışınız.

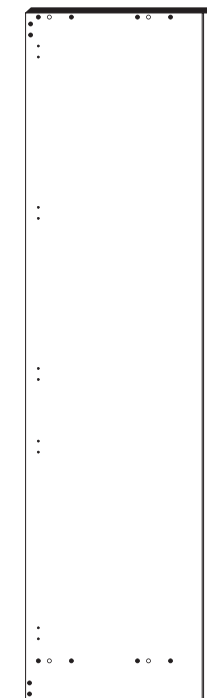

20 1 x

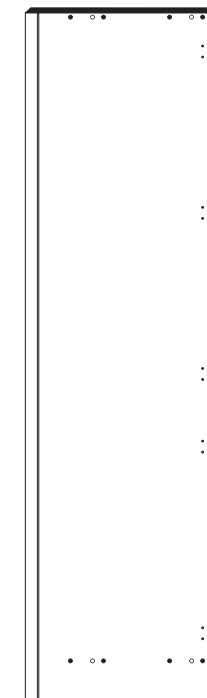

21 1 x

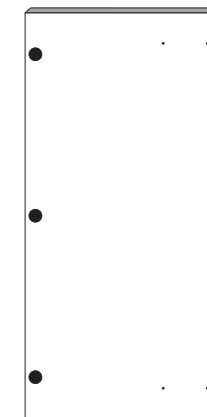

22 1 x



23 1 x

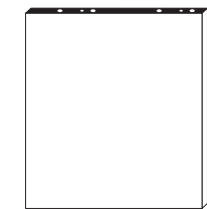

24 2 x



25 1 x

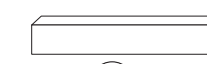

26 1 x

1

6 5 x 1611	7 3,5 x 15 4 x 2804	12 2 x 2527
---------------	---------------------------	----------------

Bitte beachten !
In dieser Aufbauanleitung ist die Tür rechts angeschlagen. Soll die Tür links angeschlagen werden, müssen die Kreuzmontageplatten 6 auf das linke Seitenteil 20 montiert werden.

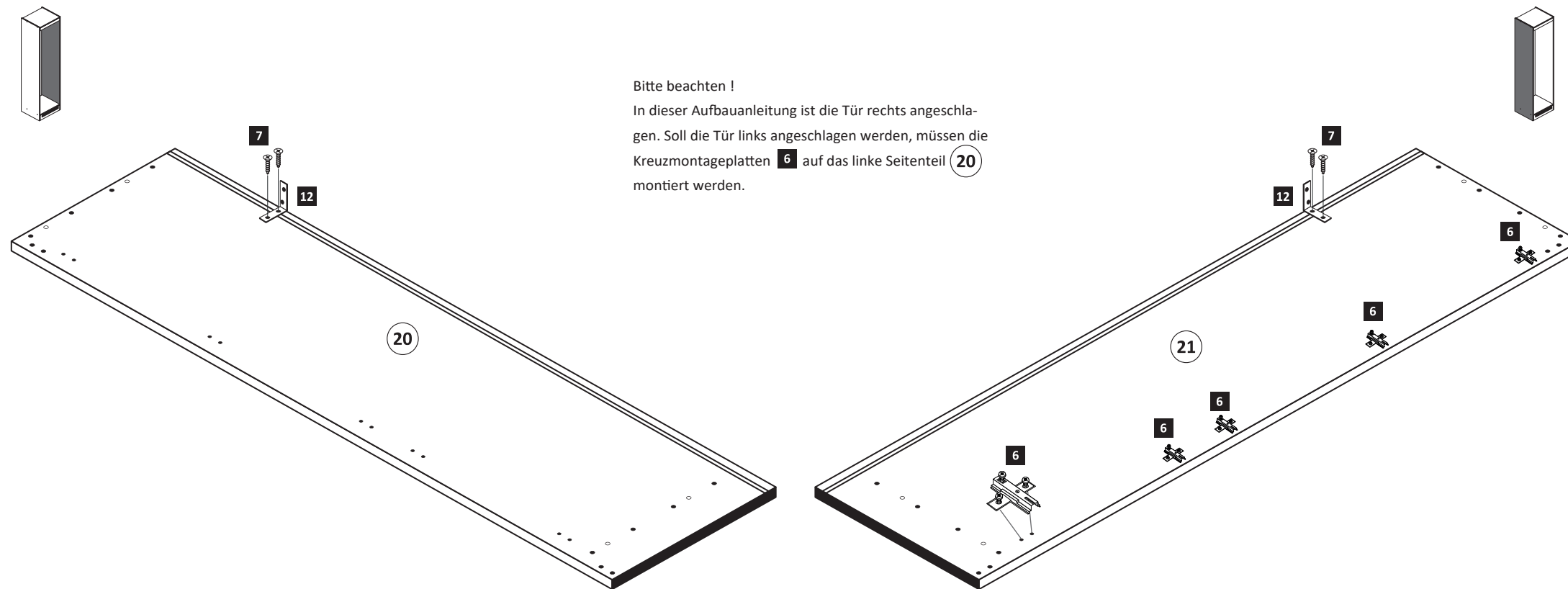

2

3 8 x 30 24 x 2861	4 Leim 1 x 2863	16 2 x 2532	17 1 x 4940
--------------------------	-----------------------	----------------	----------------

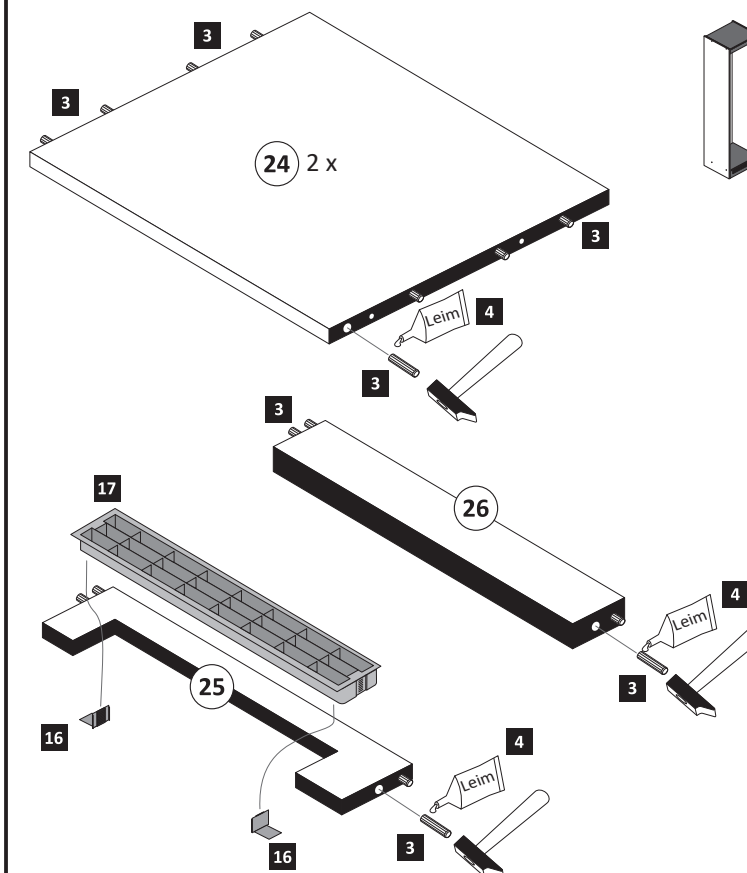

3

1 8 x 2827 2 8 x

4 Leim

24 26 21 20 25

1 2 1 2 1 2 1 2

Leim

24 25

1 2 1 2

4 Leim

1 x 2863

20 min.

D Leim
GB Glue
NL Lijm
PL Klej
TR Tutkal
F Colle
I Colla

5

5 3 x 1503 7 3,5 x 15 11 6 x 2804 2 x 2865

22 11 1

2. $\varnothing 5 \text{ mm}$

5 7 11

1. 11

ACHTUNG !
Montagebeispiel Rechtsanschlag
Bei Linksanschlag andere
Griffbohrungen durch bohren !

4

5 2 x 1503 7 3,5 x 15 11 4 x 2804 2 x 2865

23 11 1

2. $\varnothing 5 \text{ mm}$

5 7 11

1. 11

ACHTUNG !
Montagebeispiel Rechtsanschlag
Bei Linksanschlag andere
Griffbohrungen durch bohren !

6

8 2 x 9 4 x 5mm 4 x 2855

22 23 8 8

10 9 9 10

7

13 4 x 45 2 x 2814 14 6 x 34 2 x 2844

20 21 14 12 13

8

15 4 x 9 5 x 30 2 x 1 x

a b

1. 2. $\varnothing 5 \text{ mm}$

1. 2. 3. 15

**D****Wichtige Pflegehinweise**

Bitte beachten Sie die wichtigen Pflegehinweise auf unserer Internetseite

www.till-hilft.de

Pflegehinweise

**PL****Ważne instrukcje dotyczące pielęgnacji**

Zwróć uwagę na ważną instrukcję dotyczącą pielęgnacji na naszej stronie internetowej

www.till-hilft.de

Pflegehinweise

**GB****Important care instructions**

Please note the important care instructions on our website

www.till-hilft.de

Pflegehinweise

**SK****Dôležité pokyny na starostlivosť**

Dbajte na dôležité pokyny týkajúce sa starostlivosti na našich webových stránkach

www.till-hilft.de

Pflegehinweise

**FR****Instructions d'entretien importantes**

S'il vous plaît noter les instructions de soins importants sur notre site Web

www.till-hilft.de

Pflegehinweise

**HU****Fontos kezelési utasítások**

Kérjük, vegye figyelembe a honlapunkon található fontos kezelési útmutatót

www.till-hilft.de

Pflegehinweise

**IT****Importanti istruzioni per la cura**

Si prega di notare le importanti istruzioni per la cura sul nostro sito web

www.till-hilft.de

Pflegehinweise

**RO****Instrucțiunile importante de îngrijire**

Rețineți instrucțiunile importante de îngrijire de pe site-ul nostru

www.till-hilft.de

Pflegehinweise

**NL****Belangrijke zorginstructies**

Let op de belangrijke zorginstructies op onze website

www.till-hilft.de

Pflegehinweise

**TR****Önemli bakım talimatları**

Lütfen web sitemizdeki önemli bakım talimatlarını dikkate alınız

www.till-hilft.de

Pflegehinweise

**CZ****Důležité pokyny pro péči**

Vezměte prosím na vědomí důležité pokyny pro péči na našich webových stránkách

www.till-hilft.de

Pflegehinweise

**RU****Важные инструкции по уходу**

Обратите внимание на важные инструкции по уходу на нашем веб-сайте

www.till-hilft.de

Pflegehinweise



**D****Wichtige Pflegehinweise**

Bitte beachten Sie die wichtigen Pflegehinweise auf unserer Internetseite

www.till-hilft.de

Pflegehinweise

**PL****Ważne instrukcje dotyczące pielęgnacji**

Zwróć uwagę na ważną instrukcję dotyczącą pielęgnacji na naszej stronie internetowej

www.till-hilft.de

Pflegehinweise

**GB****Important care instructions**

Please note the important care instructions on our website

www.till-hilft.de

Pflegehinweise

**SK****Dôležité pokyny na starostlivosť**

Dbajte na dôležité pokyny týkajúce sa starostlivosti na našich webových stránkach

www.till-hilft.de

Pflegehinweise

**FR****Instructions d'entretien importantes**

S'il vous plaît noter les instructions de soins importants sur notre site Web

www.till-hilft.de

Pflegehinweise

**HU****Fontos kezelési utasítások**

Kérjük, vegye figyelembe a honlapunkon található fontos kezelési útmutatót

www.till-hilft.de

Pflegehinweise

**IT****Importanti istruzioni per la cura**

Si prega di notare le importanti istruzioni per la cura sul nostro sito web

www.till-hilft.de

Pflegehinweise

**RO****Instrucțiunile importante de îngrijire**

Rețineți instrucțiunile importante de îngrijire de pe site-ul nostru

www.till-hilft.de

Pflegehinweise

**NL****Belangrijke zorginstructies**

Let op de belangrijke zorginstructies op onze website

www.till-hilft.de

Pflegehinweise

**TR****Önemli bakım talimatları**

Lütfen web sitemizdeki önemli bakım talimatlarını dikkate alınız

www.till-hilft.de

Pflegehinweise

**CZ****Důležité pokyny pro péči**

Vezměte prosím na vědomí důležité pokyny pro péči na našich webových stránkách

www.till-hilft.de

Pflegehinweise

**RU****Важные инструкции по уходу**

Обратите внимание на важные инструкции по уходу на нашем веб-сайте

www.till-hilft.de

Pflegehinweise

