

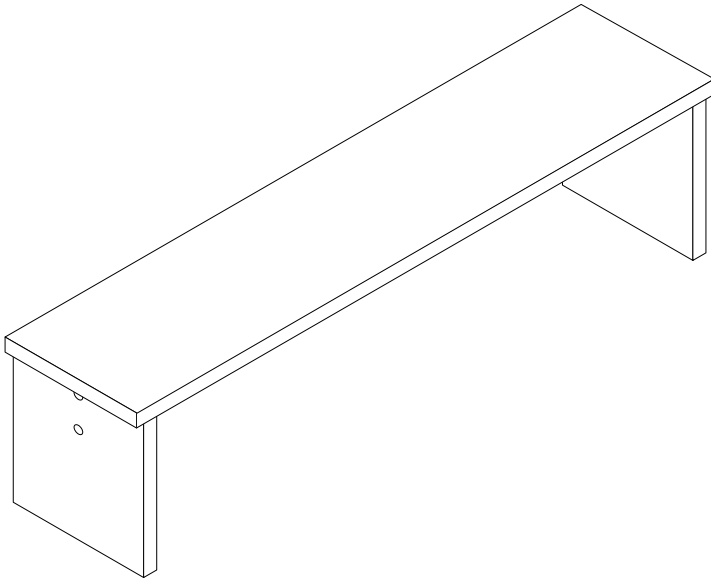

- | | | |
|---|--|--|
| (D) Videounterstützte Montageanleitung | (GB) Video-assisted assembly instructions | (FR) Instructions de montage assistées par vidéo |
| (TR) Video destekli kurulum talimatları | (IT) Istruzioni di montaggio video-assistite | (NL) Video-ondersteunde montage-instructies |
| (RU) инструкция по монтажу с помощью видеосигнала | (CZ) Instalační pokyny podporované videem | (HU) Video-támogatott telepítési utasítások |
| (RO) Instrucțiuni de instalare acceptate video | (PL) Instrukcje montażu wspomagane sygnałem wizyjnym | (SK) Inštaláčne pokyny podporované videom |

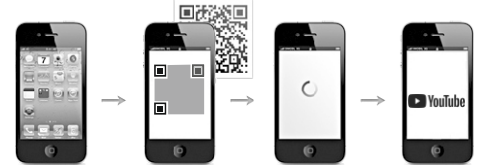

Art.-Nr.: **0585_160**
Bank_160

REPC-Nr.:

**Service • Assistenza • Dienstverlening • Serwis
Servis • Szerviz • Сервисная служба**

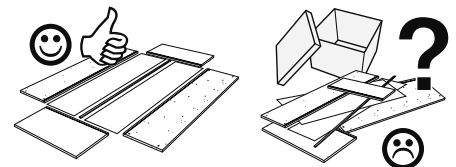
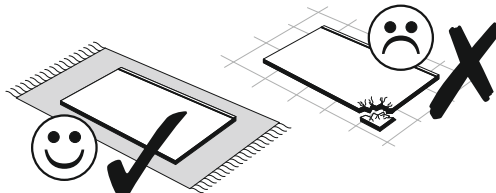
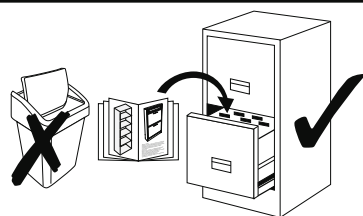
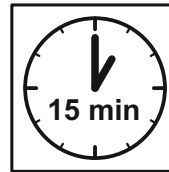
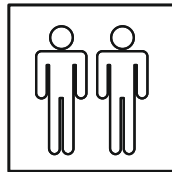
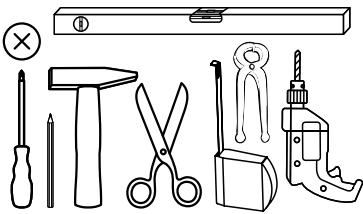

SCAN ME

Das Ersatzteil-Anforderungsformular finden Sie auf
The replacement parts requisition form you find on
<https://www.maeusbacher.de/ersatzteile/>

Beutel 0585_1600-11

B01-20		B02-10		B02-20		B05-10	
4x	7,0x70	4x	ø15x12mm	4x	4x	4x	



▶ SCAN ME

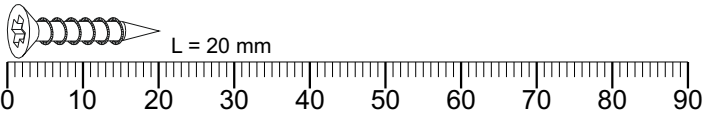

Colli 1/1

