

(D) Montageanleitung

(GB) Assembly instructions

(FR) Notice de montage

(IT) Istruzioni di montaggio

(NL) Handleiding voor de montage

(PL) Instrukcja montażu

(CZ) Montážní návod

(SK) Návod na montáž

(HU) Szerelési útmutató

(RO) Instrucțiuni de montaj

(TR) Montaj talimatı

(RU) Инструкция по монтажу

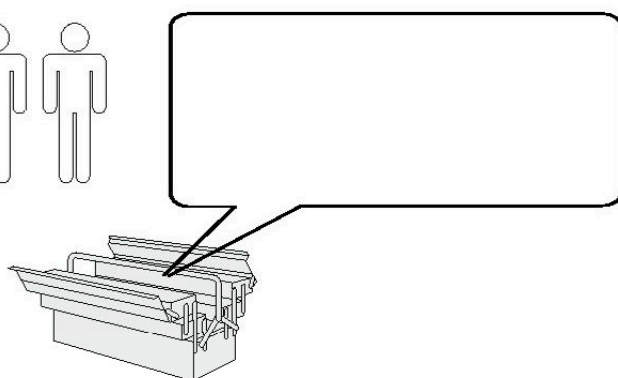
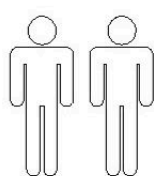

**Service • Assistenza • Dienstverlening • Serwis
Servis • Szerviz • Сервисная служба**

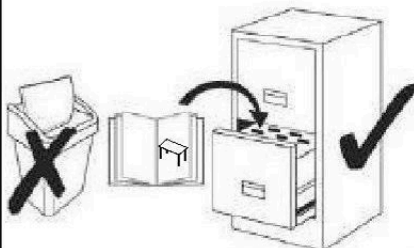
Name • Nom • Nome • Naam Nazwa • Jméno • Názov • Név Denumire • İsim • Название	MARKUS
Nr. • No. • N° • Номер • Č • Sz	7801 1443 6274 2716 8254 1059
Typ • Type • Tip • Típus • Tipo Тип	
	
	

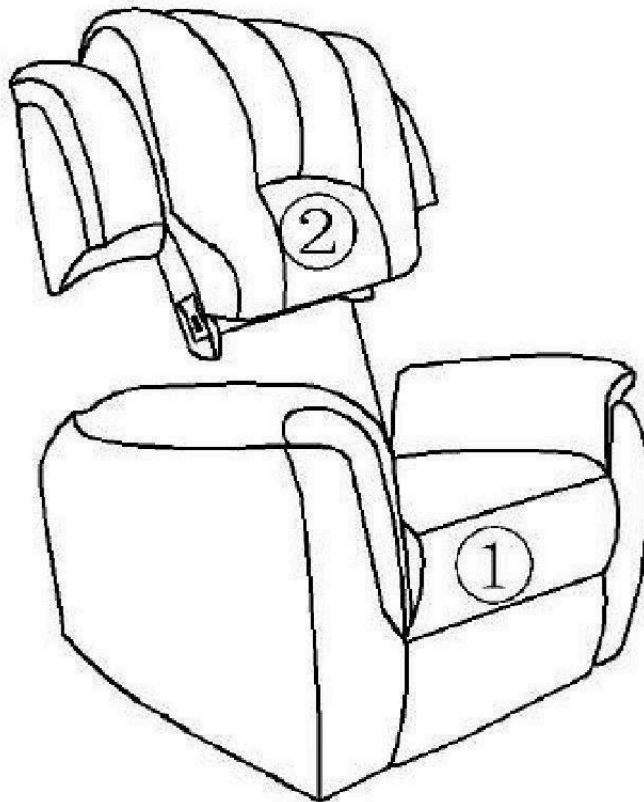
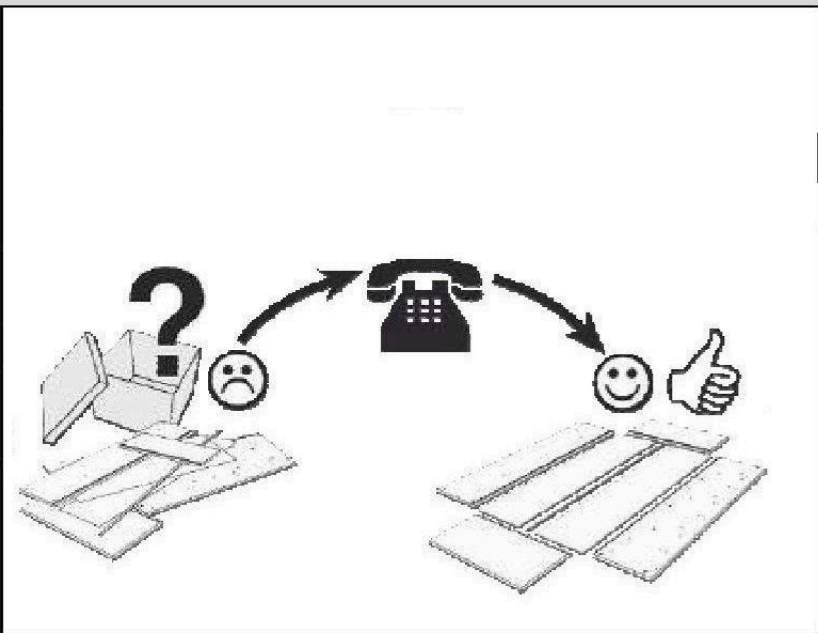

1

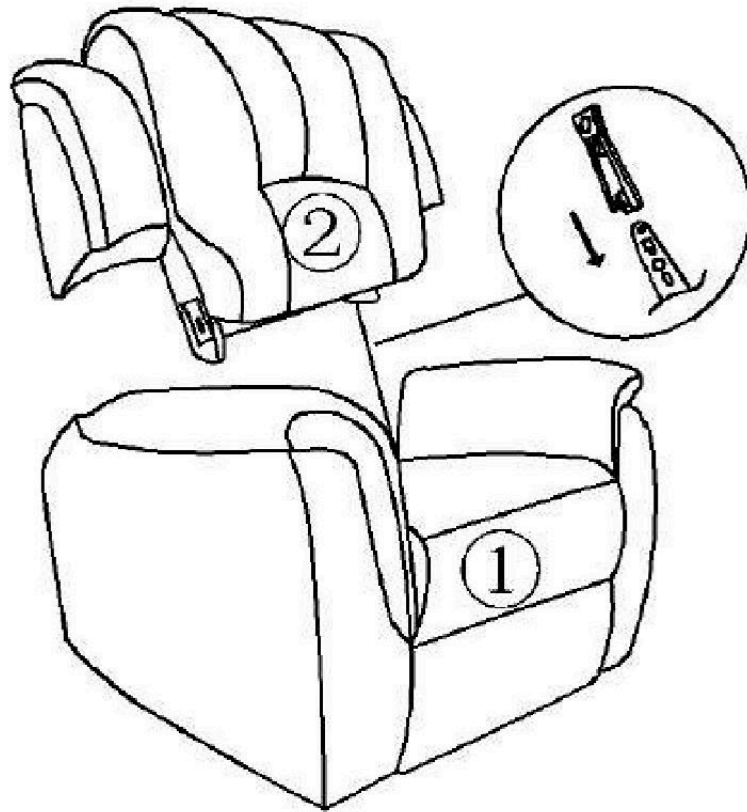

2

