

Anleitung

Assembly Instruction

Le manuel d'emploi

WF314300



TIPP











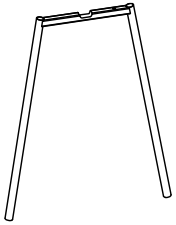

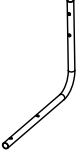
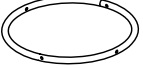
1. Vielen Dank für Ihren Einkauf! Wir sind bestrebt, Ihnen qualitativ hochwertige Produkte anzubieten. Im unwahrscheinlichen Fall, dass Ihr Produkt beschädigt ist, Teile fehlen oder beim Zusammenbau Probleme auftreten, wenden Sie sich bitte an unseren Kundendienst. Wir werden Ihnen so schnell wie möglich die beste Lösung anbieten. Um Ihr Problem schnell zu lösen, stellen Sie uns bitte einige Bilder zur Verfügung, die das Produktproblem deutlich wiedergeben. Danke !
2. Bitte bewahren Sie beim Zusammenbau alle Kleinteile außerhalb der Reichweite von Kindern auf. Kann bei Verschlucken oder Einatmen tödlich sein. Kinder sollten nicht auf das Produkt klettern oder darauf spielen, um schwere Verletzungen durch umkippende Möbel zu vermeiden. Um mögliche Verletzungen durch Bewegung zu vermeiden, halten Sie alle Teile und Verpackungen (Folie, Plastiktüten, Schaumstoff usw.) von Säuglingen und Kindern fern.
3. Bitte ordnen Sie die entsprechenden Teile und Zubehörteile den Teilenummern im Handbuch zu. Wenn Teile und Zubehör nicht übereinstimmen, überprüfen Sie die Angaben in diesem Handbuch. Richten Sie beim Zusammenbau zunächst alle Schrauben locker an den entsprechenden vorgebohrten Löchern aus und ziehen Sie dann die Schrauben nacheinander fest. Überprüfen Sie während des Produktgebrauchs regelmäßig den festen Sitz der Schrauben und ziehen Sie sie bei Bedarf nach, um die strukturelle Integrität sicherzustellen. Bitte halten Sie scharfe und ätzende Gegenstände vom Produkt fern, um Schäden oder Verletzungen zu vermeiden.
4. Es wird empfohlen, dass 2 Personen zusammen reisen

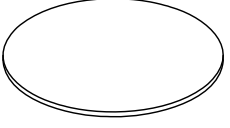
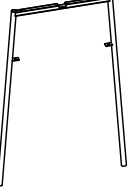
TIPS

1. Thank you for your purchase! We are committed to providing you with high quality products. In the unlikely event that your product is damaged, missing parts or has problems with assembly, please contact our customer service team. We will offer you the best solution as soon as possible. In order to solve your problem quickly, please provide us with some pictures that clearly show the product problem. Thanks !
2. Please keep all small parts out of the reach of children when assembling. May be fatal if swallowed or inhaled. Children should not climb or play on the product to avoid serious injury from furniture tipping over. To avoid possible injury from movement, keep all parts and packaging (film, plastic bags, foam, etc.) away from infants and children.
3. Please match the corresponding parts and accessories to the part numbers in the manual. If parts and accessories do not match, check the information in this manual. When assembling, first align all screws loosely with the corresponding pre-drilled holes and then tighten the screws one by one. During product use, periodically check the tightness of screws and tighten as necessary to ensure structural integrity. Please keep sharp and corrosive objects away from the product to avoid damage or injury.
4. It is recommended that 2 people travel together

Conseil

1. Merci pour votre achat ! Nous nous engageons à vous fournir des produits de haute qualité. Dans le cas peu probable où votre produit serait endommagé, des pièces manquantes ou aurait des problèmes d'assemblage, veuillez contacter notre service client. Nous vous proposerons la meilleure solution dans les plus brefs délais. Afin de résoudre votre problème rapidement, veuillez nous fournir quelques photos montrant clairement le problème du produit. Merci !
2. Veuillez garder toutes les petites pièces hors de portée des enfants lors de l'assemblage. Peut être mortel en cas d'ingestion ou d'inhalation. Les enfants ne doivent pas grimper ou jouer sur le produit pour éviter des blessures graves en cas de renversement des meubles. Pour éviter d'éventuelles blessures liées aux mouvements, gardez toutes les pièces et tous les emballages (film, sacs en plastique, mousse, etc.) hors de portée des nourrissons et des enfants.
3. Veuillez faire correspondre les pièces et accessoires correspondants aux numéros de pièces dans le manuel. Si les pièces et les accessoires ne correspondent pas, vérifiez les informations contenues dans ce manuel. Lors de l'assemblage, alignez d'abord toutes les vis sans serrer avec les trous pré-perçés correspondants, puis serrez les vis une par une. Pendant l'utilisation du produit, vérifiez périodiquement le serrage des vis et serrez si nécessaire pour garantir l'intégrité structurelle. Veuillez garder les objets pointus et corrosifs éloignés du produit pour éviter tout dommage ou blessure.
4. Il est recommandé que 2 personnes voyagent ensemble

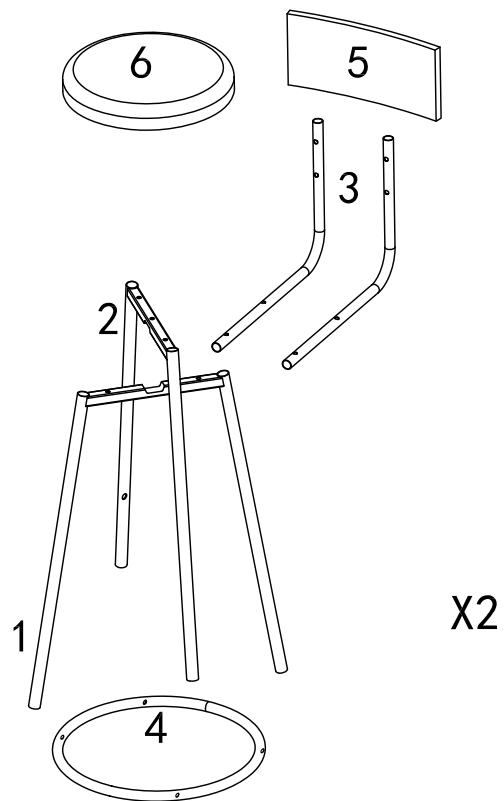
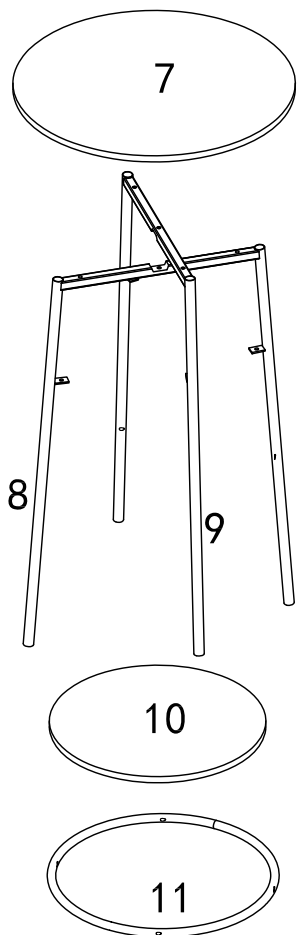

1  X2	2  X2	3  X4	4  X2	5  X2
6  X2	7  X1	8  X1	9  X1	10  X1
11  X1	A  M6X35mm X10	B  M6X30mm X21	C  M6X25mm X12	D  M6X12mm X4
E  M4 X1				



X2

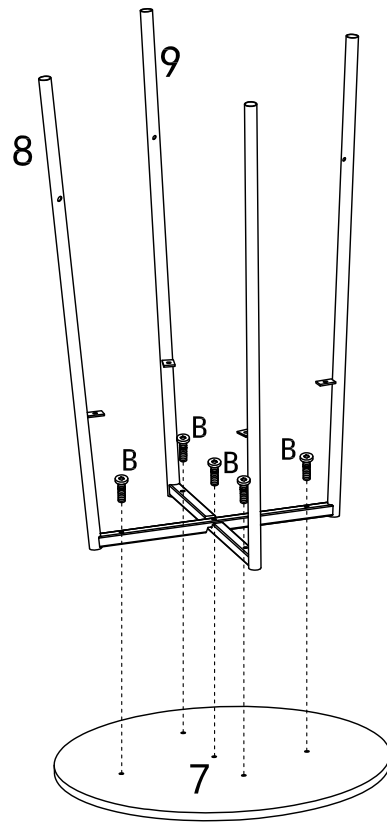

Schritt 1



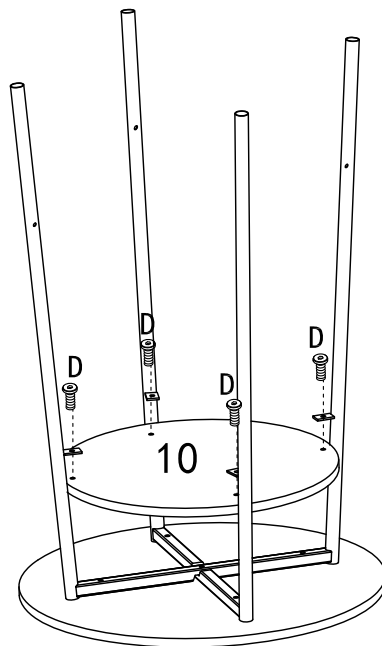

B	X5	E	X1
			
M6X30mm		M4	

Schritt 2





D	X4	E	X1
			
M6X12mm		M4	

Schritt 3

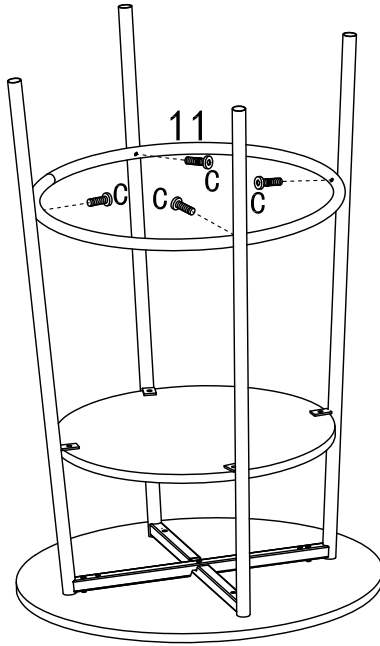
C	X4	E	X1
			
M6X25mm		M4	



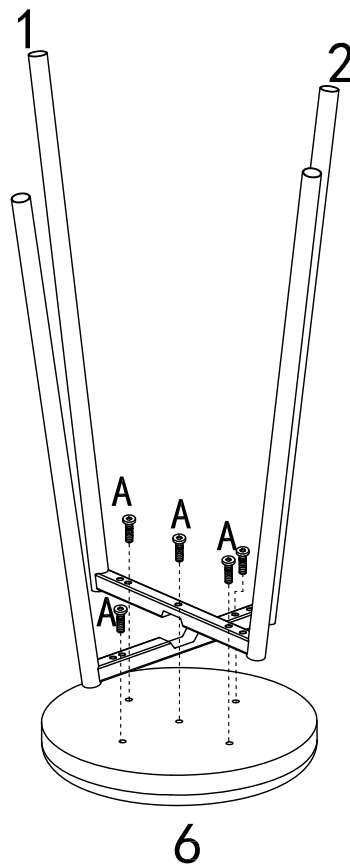

Schritt 4

A	X10	E	X1
			
M6X35mm		M4	



X2

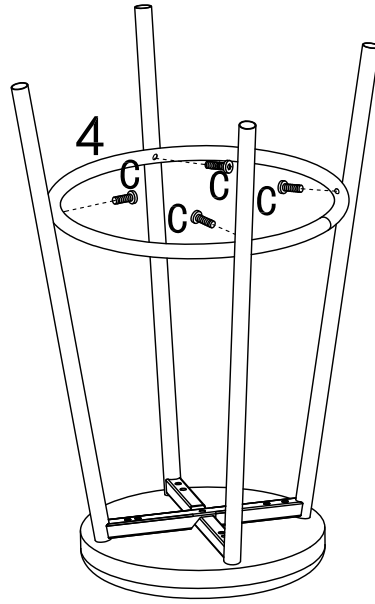

Schritt 5

C	X8	E	X1
			
M6X25mm		M4	



X2

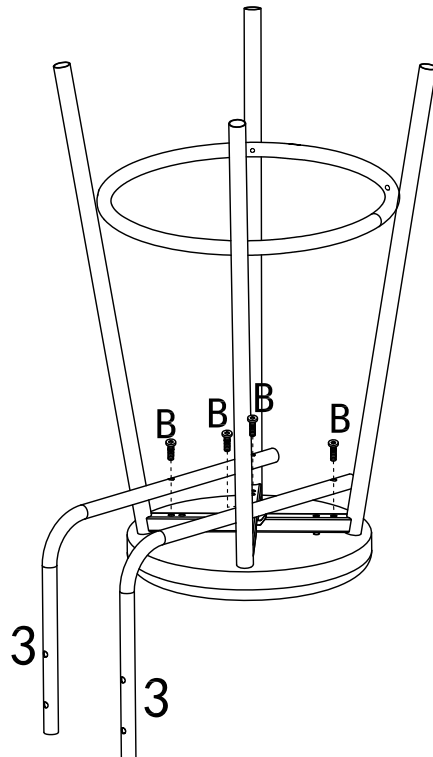

Schritt 6

B	X8	E	X1
			
M6X30mm		M4	



X2

Schritt 7

B	X8	E	X1
			
M6X30mm		M4	

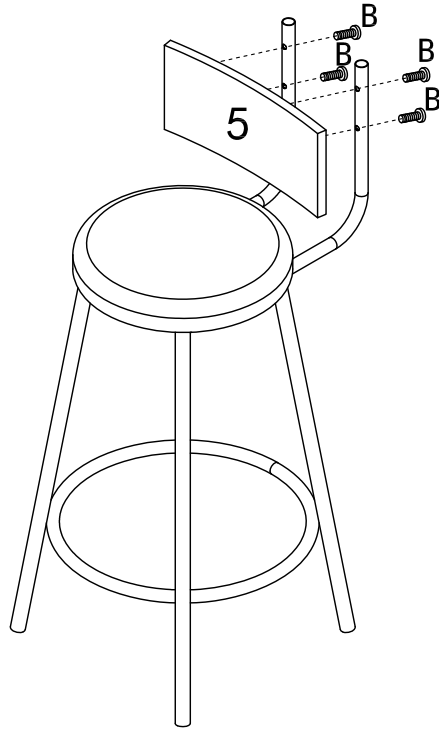

X2

Schritt 8

