

(D) Montageanleitung

(GB) Assembly instructions

(FR) Notice de montage

(IT) Istruzioni di montaggio

(NL) Handleiding voor de montage

(PL) Instrukcja montażu

(CZ) Montážní návod

(SK) Návod na montáž

(HU) Szerelési útmutató

(RO) Instrucțiuni de montaj

(TR) Montaj talimatı

(RU) Инструкция по монтажу



Ausgabe:20130830

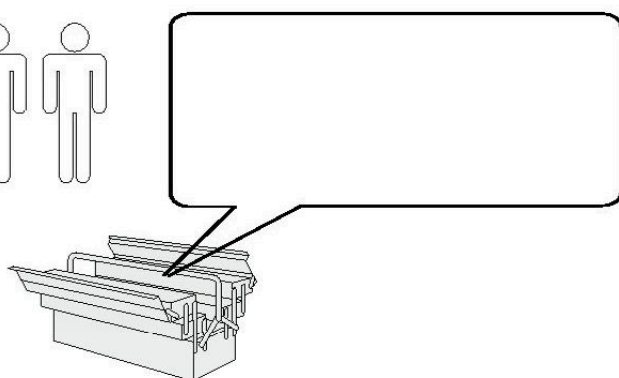
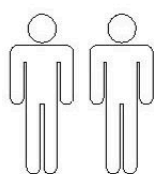

**Service • Assistenza • Dienstverlening • Serwis
Servis • Szerviz • Сервисная служба**

Name • Nom • Nome • Naam
Nazwa • Jméno • Názov •
Név
Denumire • Ísim • Название

DIANA

Nr. • No. • N° • Номер • Č •
Sz

7115 4067

2231 7040

Typ • Type • Tip • Típus •

Tipo

Тип

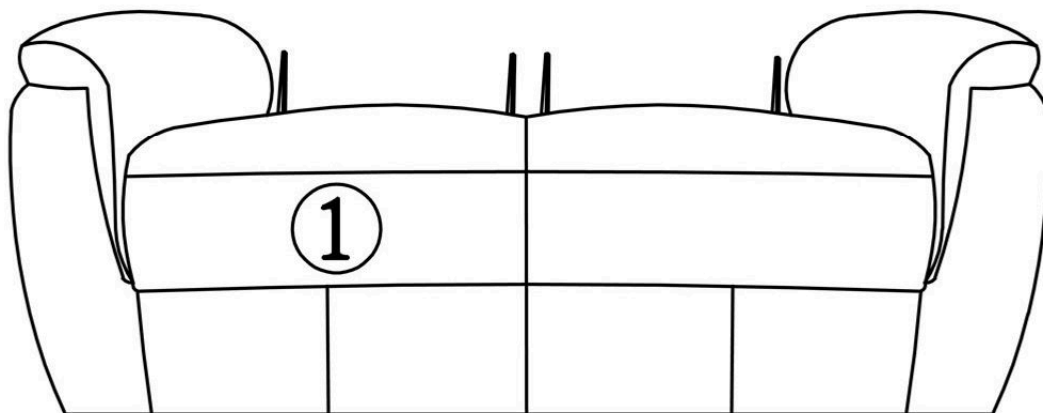
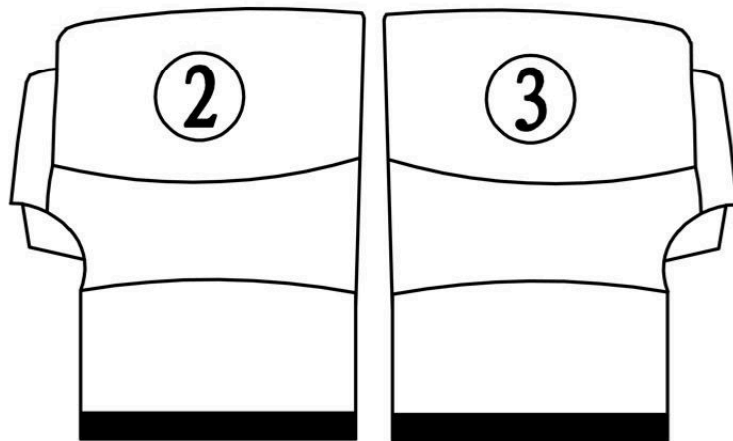
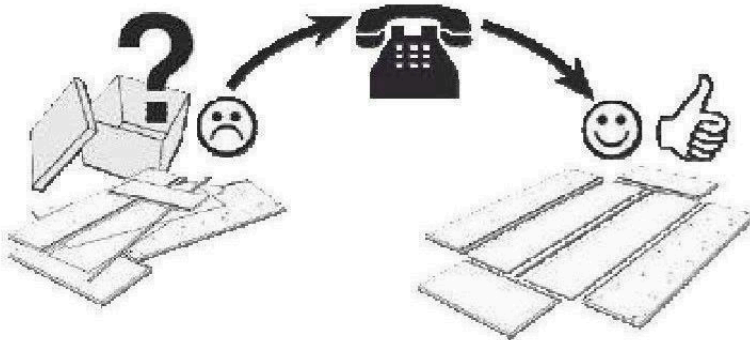
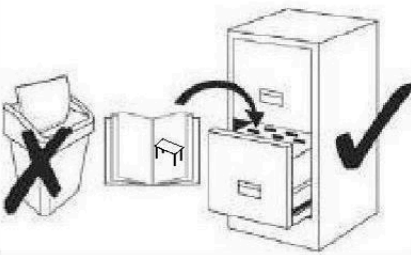

1

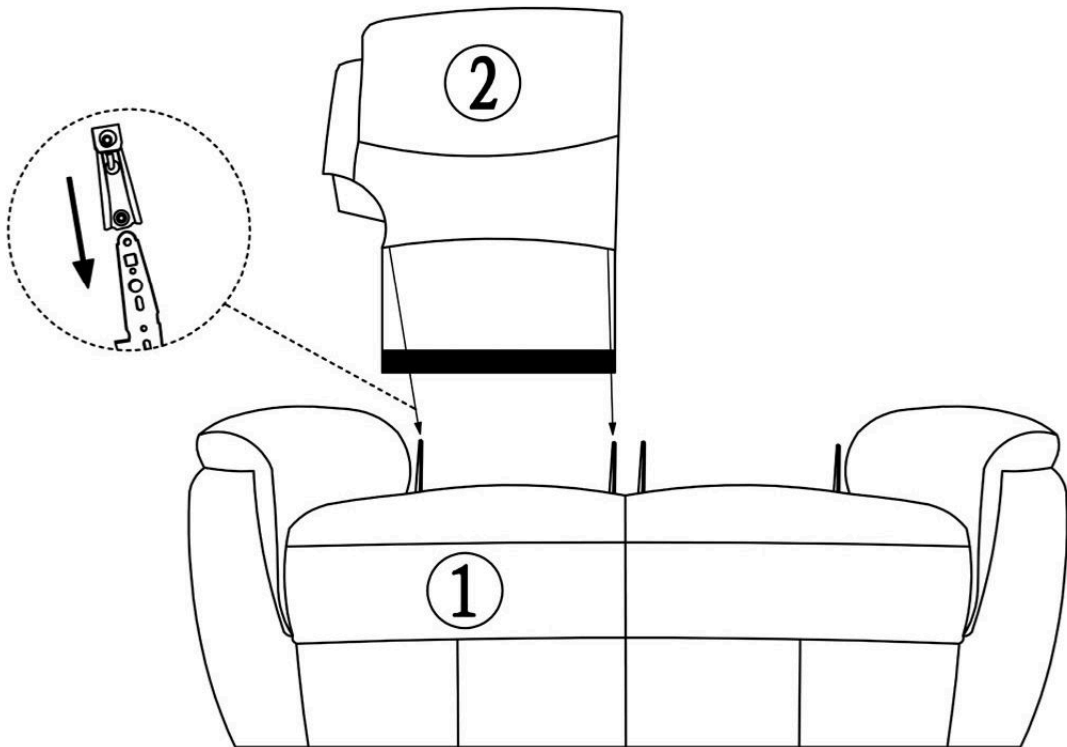

2

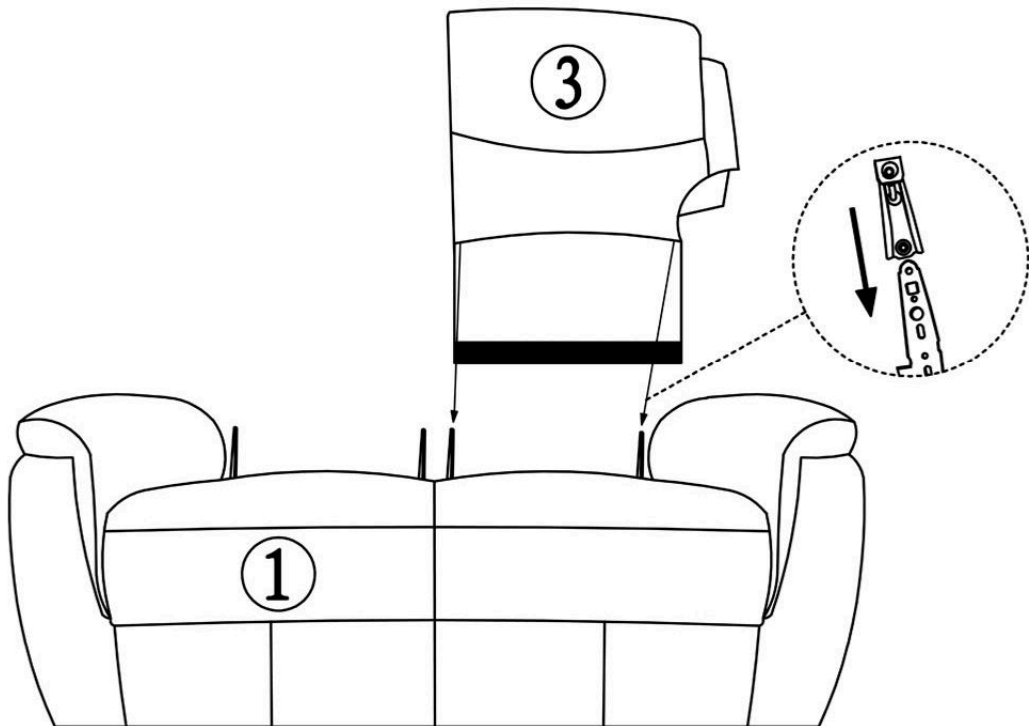

3

