

980731

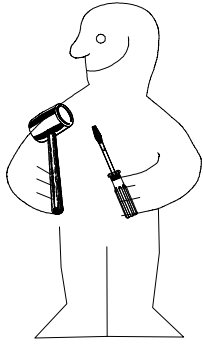

1.



2.

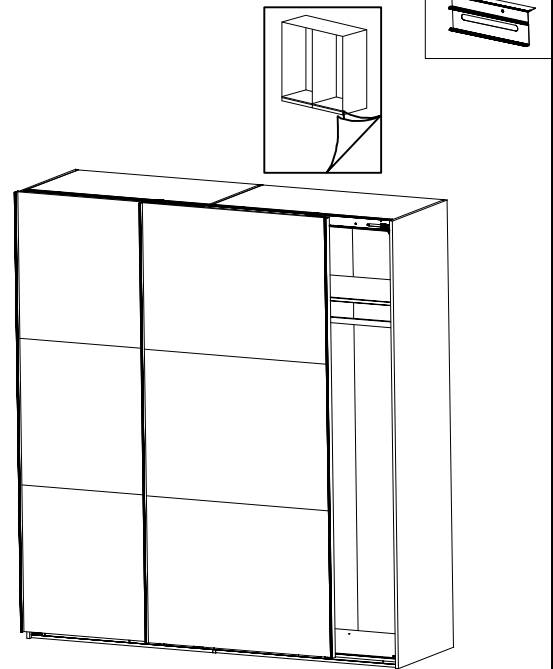
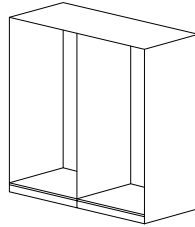

HSP 200

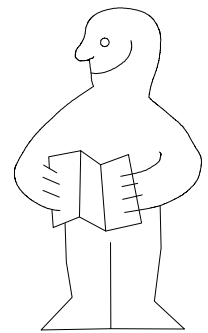
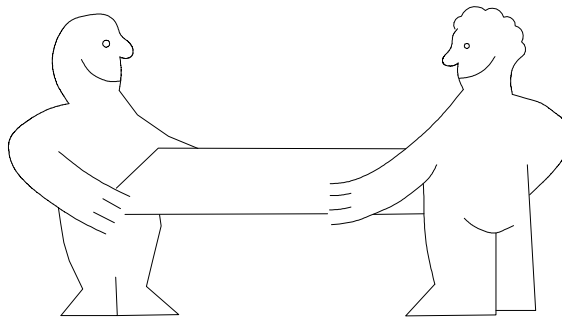
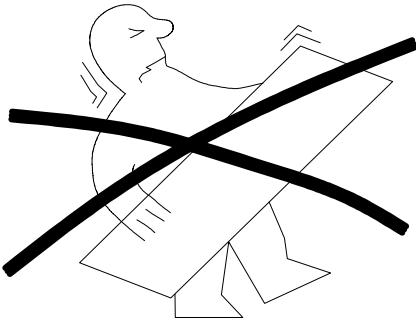

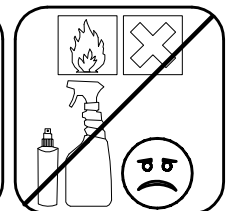
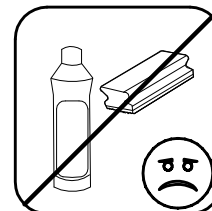
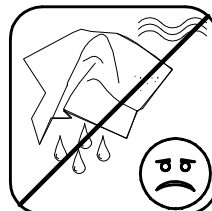
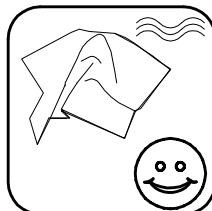
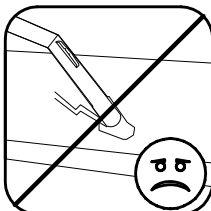
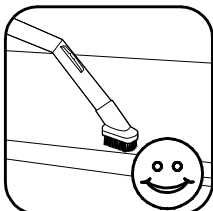
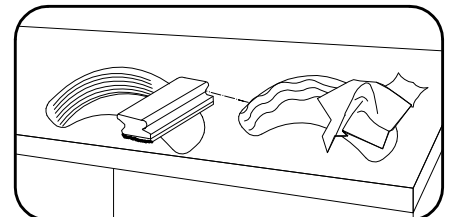
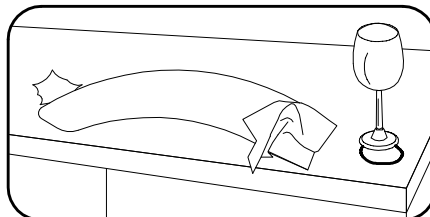
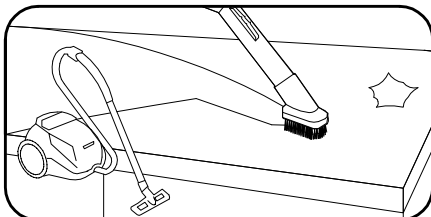
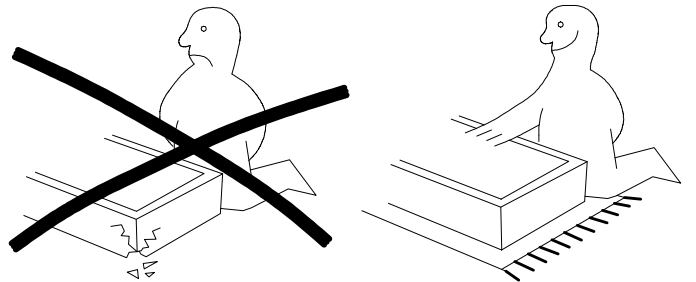
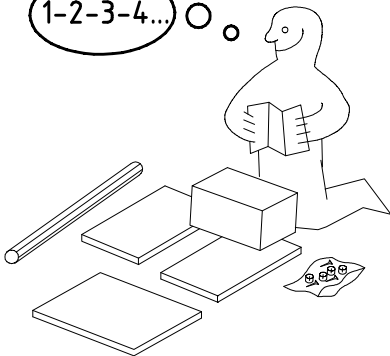

1-2-3-4... ○ ○







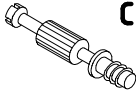

980731

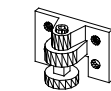

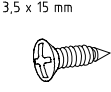
19.05.24 / -



05 24 | 1/14

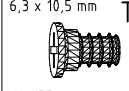

|   |    |     |
|---|----|-----|
| <br>111 149  | A1 | 16x |
| <br>111 103 | C  | 8x  |
|             | F3 | 4x  |

|   |     |     |
|---|-----|-----|
| <br>111 300         | S0  | 10x |
| <br>111 xxx<br>φ12 | V12 | 10x |
| <br>121 370        | G1  | 28x |

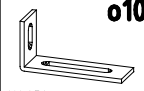
|  |      |     |
|--|------|-----|
| <br>117 002  | K2   | 4x  |
|             | SBV  | 16x |
| <br>112 420 | K100 | 2x  |

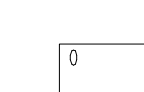
|   |    |     |
|---|----|-----|
| <br>111 611        | J2 | 6x  |
| <br>6.3 x 10,5 mm | T1 | 24x |
| <br>112 607       | L8 | 8x  |

|   |         |    |
|---|---------|----|
| <br>111 052   | o10     | 1x |
| <br>4 X 15mm | SP15    | 3x |
|              | 121 120 |    |

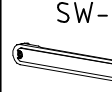
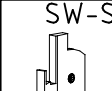
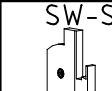
|  |        |    |
|--|--------|----|
| <br>L=1941 | SW-LP  | 1x |
| <br>L=1941 | SW-FP  | 1x |
|            | SW-AS  | 2x |
|            | SW-SKL | 1x |
|           | SW-SKR | 1x |

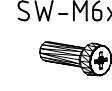
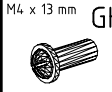
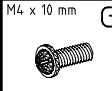
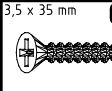
|  |          |    |
|--|----------|----|
|                             | SW-ST    | 2x |
|                             | SW-M6x20 | 2x |
| <br>M4 x 13 mm              | GH13     | 4x |
| <br>121 xxx                 | G43      | 4x |
| <br>121 xxx<br>3,5 x 35 mm | G14      | 2x |

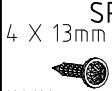
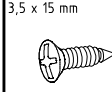
|   |        |     |
|---|--------|-----|
|                            | SW-SKM | 2x  |
| <br>4 X 13mm               | SP13   | 2x  |
| <br>121 122<br>3,5 x 15 mm | G1     | 10x |

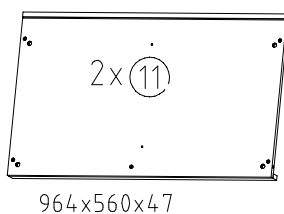
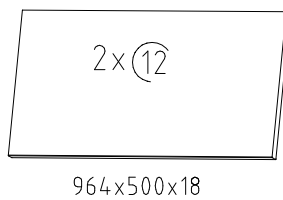
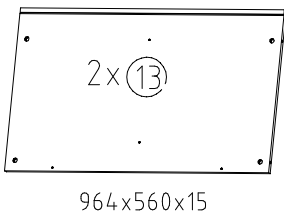
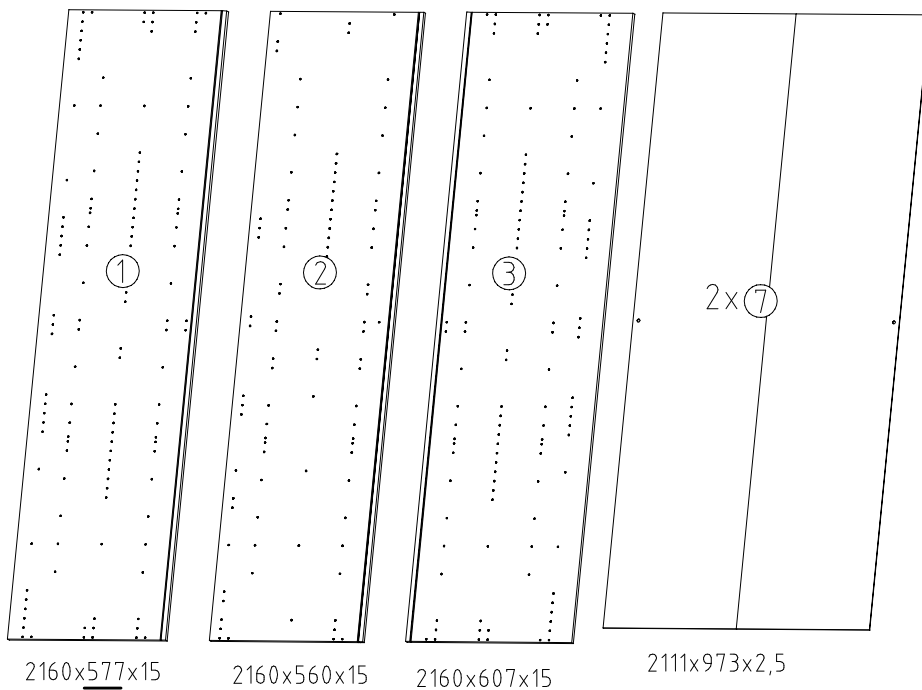
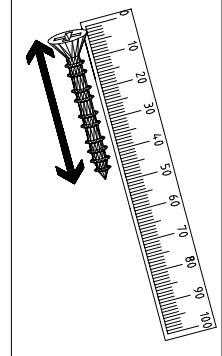
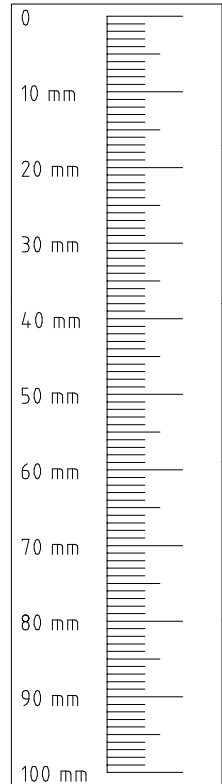
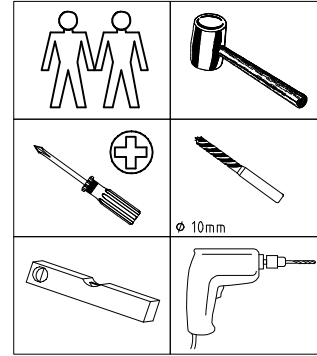

1

3,5 x 15 mm

G1

S0

A1

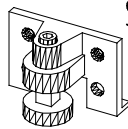
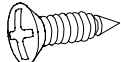

121 370

111 300

111 149

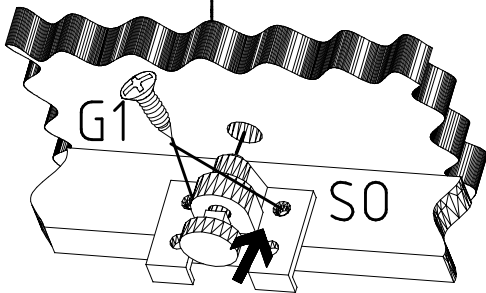
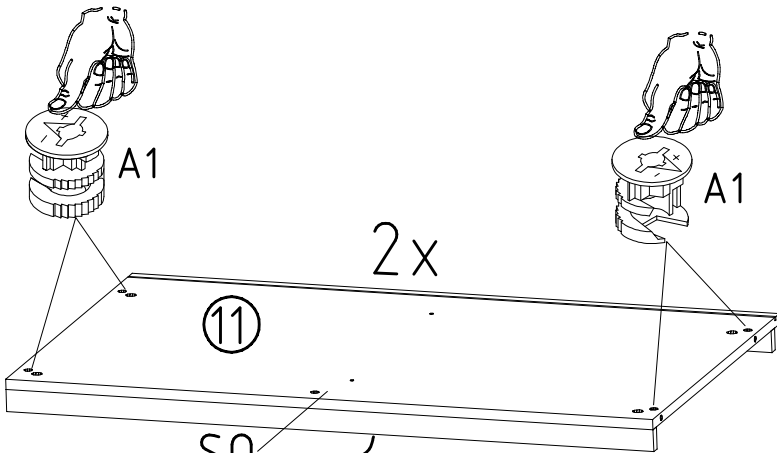

2

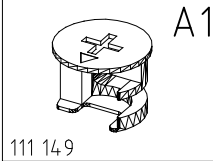

111 149

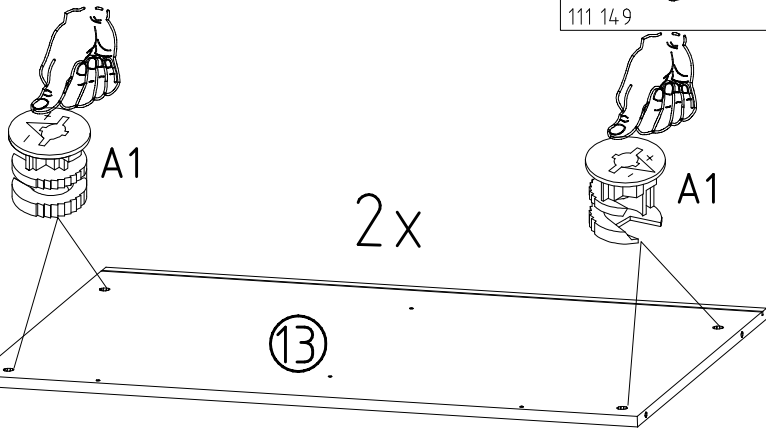

3

F3

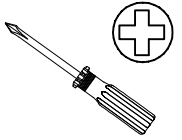

6,3 x 10,5 mm

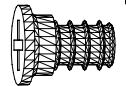

112 055

3,5 x 15 mm

G1

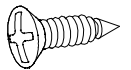

121 370

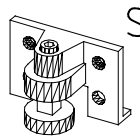

S0

111 300

F3

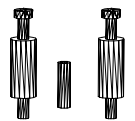

S0

F3

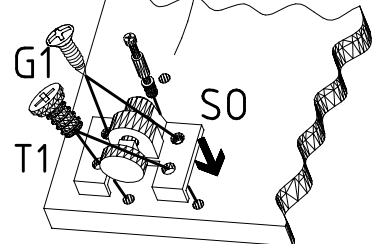
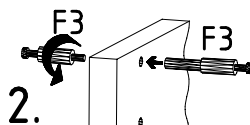
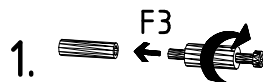

4

SW-SKL

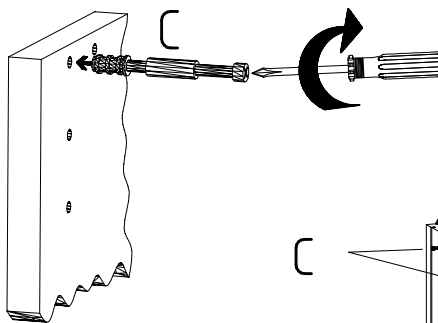
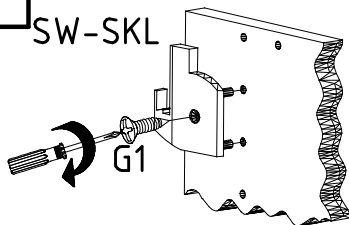

SW-SKR

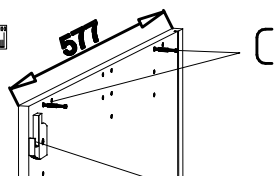
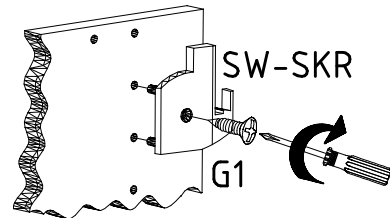

SW-SKL  
+G1

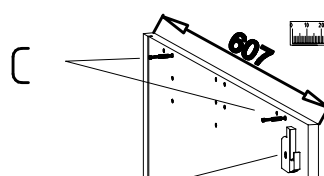

SW-SKR  
+G1

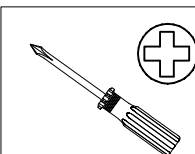

3,5 x 15 mm G1

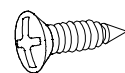

121 370

SW-SKL

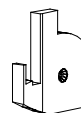

SW-SKR

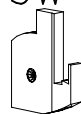

6,3 x 10,5 mm T1

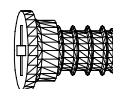

112 055

3,5 x 15 mm G1

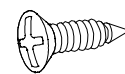

121 370

111 103 C

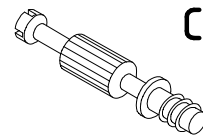

111 300 SO

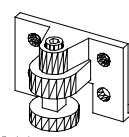

1

3

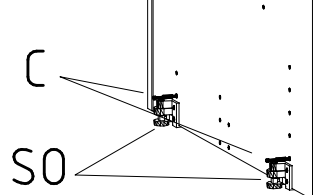
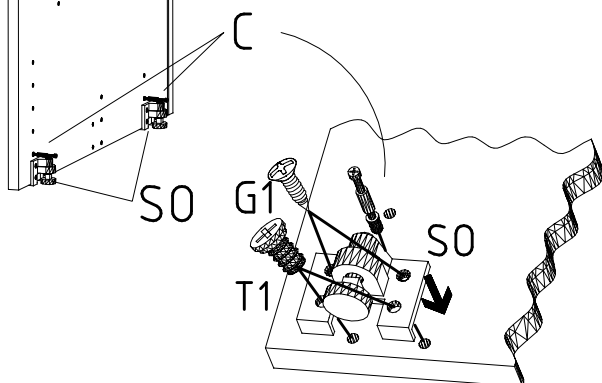

5

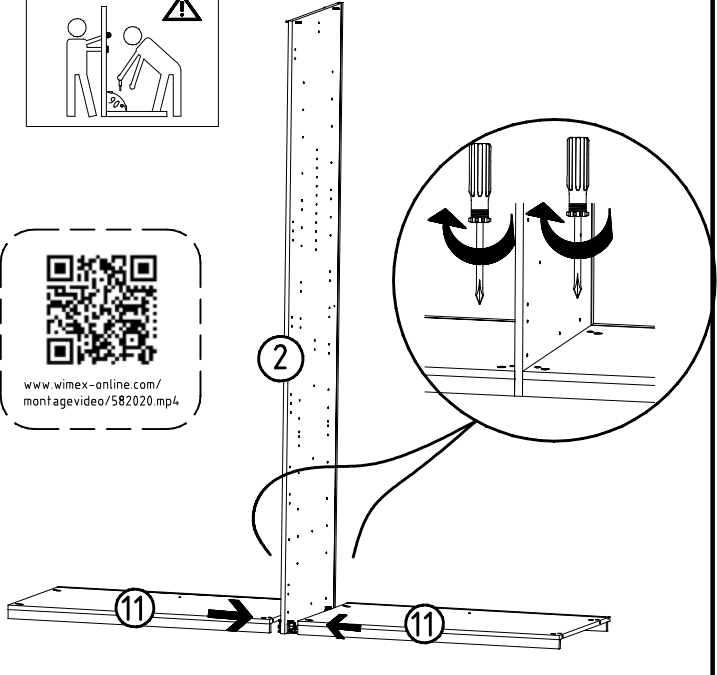
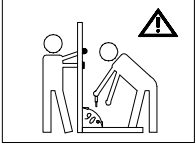
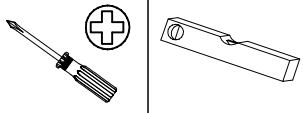

6

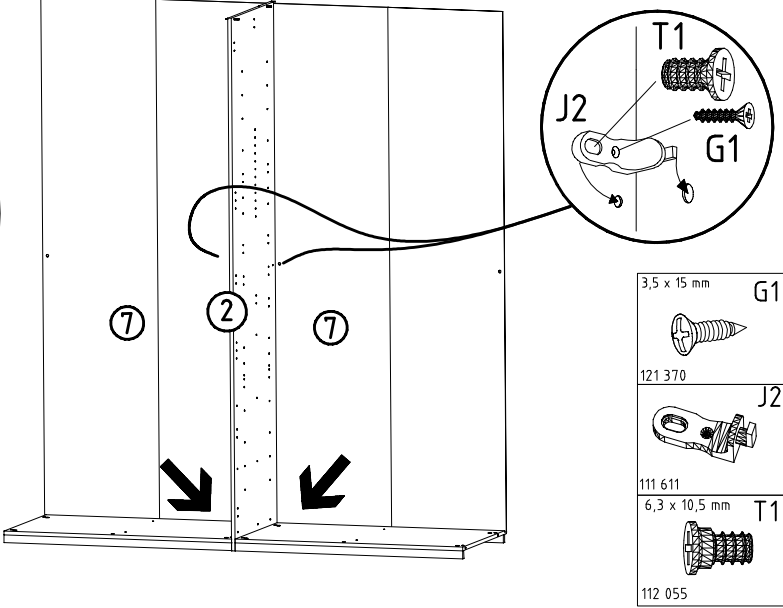
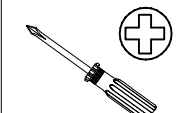

- 3,5 x 15 mm G1
- 121 370
- 111 611
- 6,3 x 10,5 mm T1
- 112 055

7

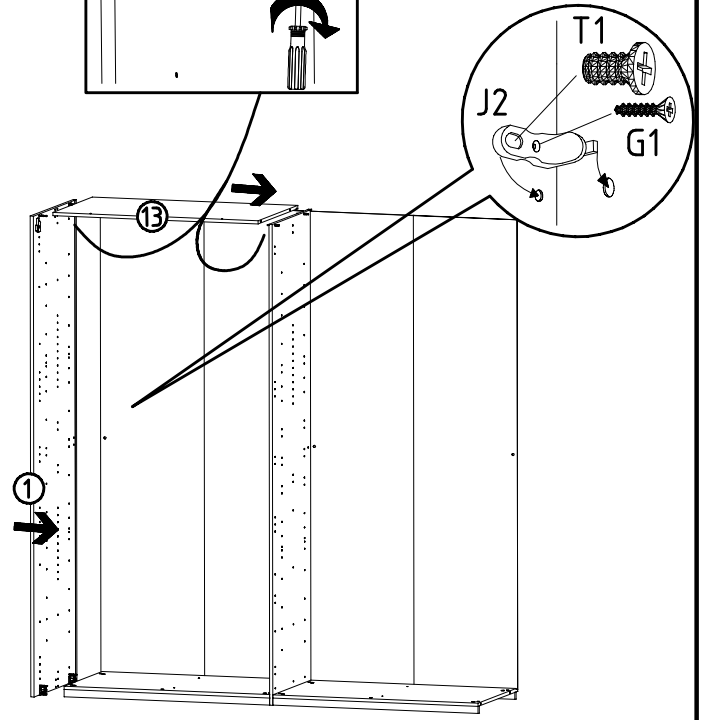
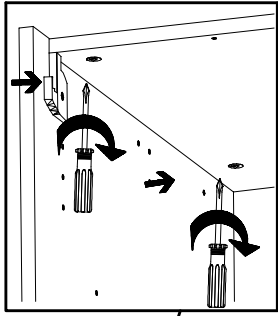

- 3,5 x 15 mm G1
- 121 370
- 6,3 x 10,5 mm T1
- 112 055
- 111 611



8

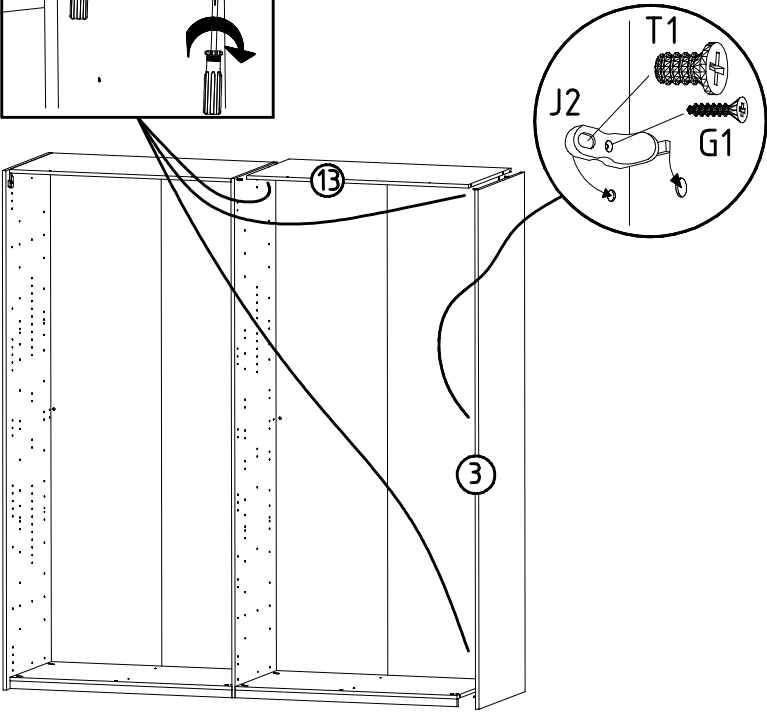
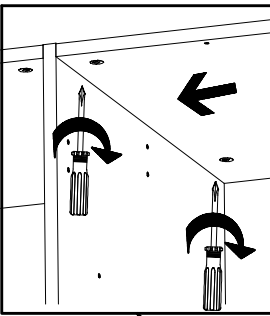

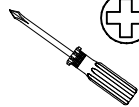
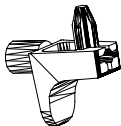
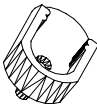
- 3,5 x 15 mm G1
- 121 370
- 6,3 x 10,5 mm T1
- 112 055
- 111 611

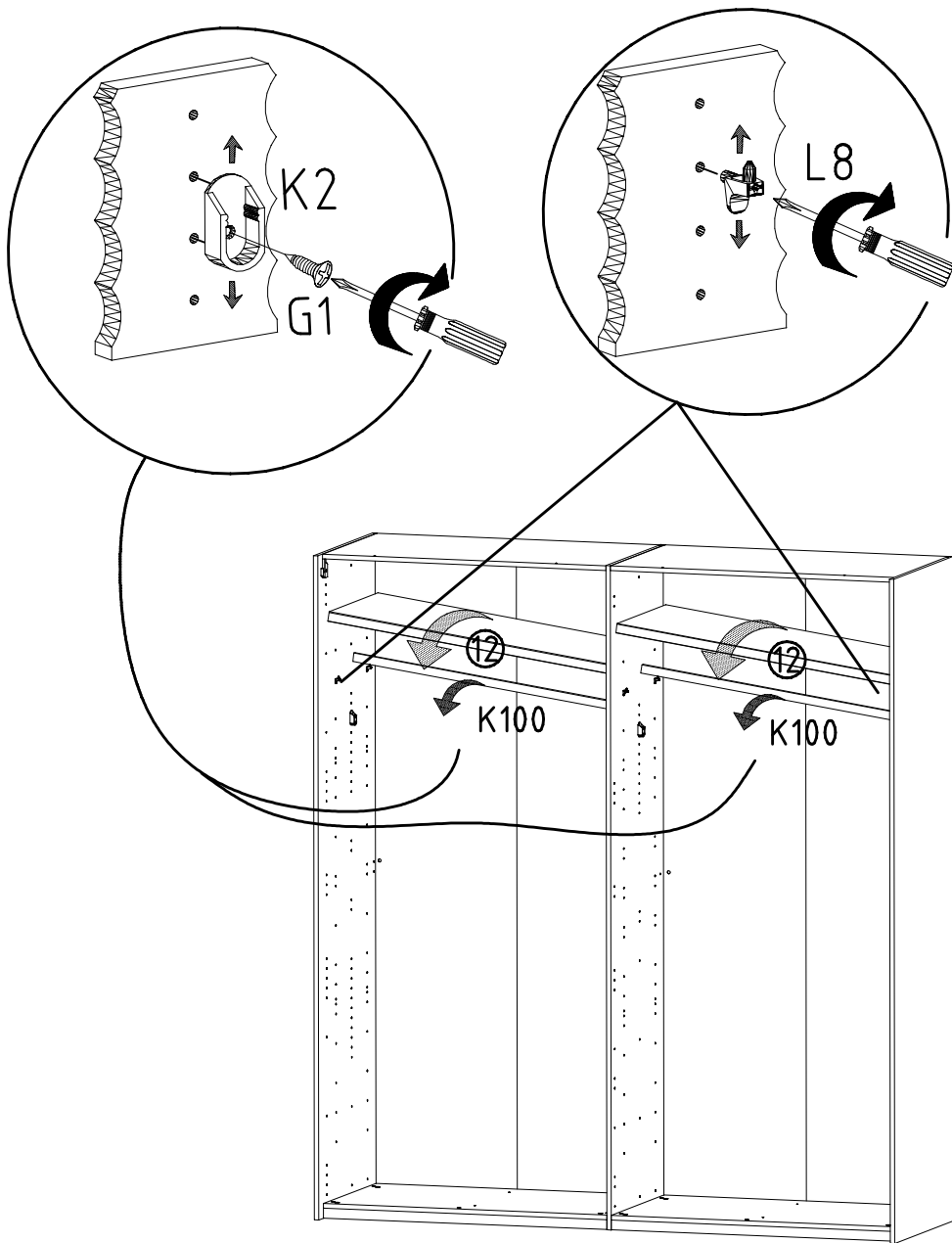

|  |   |      |
|--|---|------|
|  |   | L8   |
|  | 111 607   |      |
|  |  | K2   |
|  | 117 002   |      |
|  | 3,5 x 15 mm   | G1   |
|  |  |      |
|  | 121 370   |      |
|  |  | K100 |
|  | 957mm   |      |
|  | 112 420   |      |

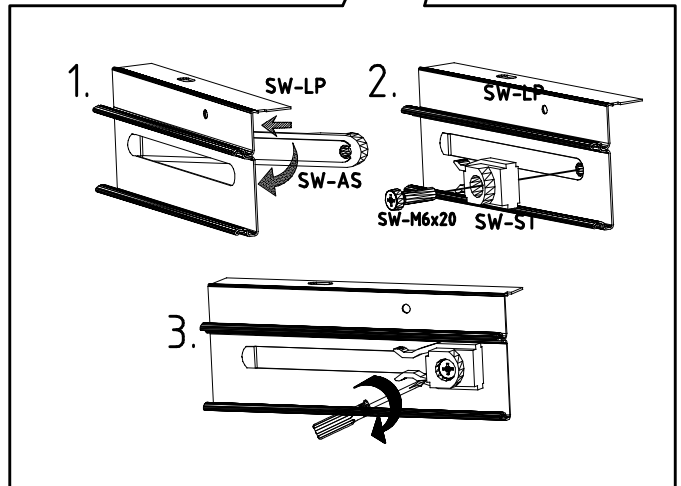
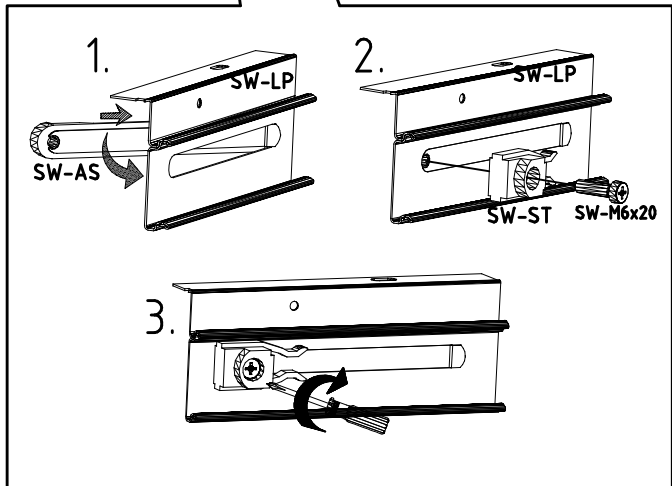
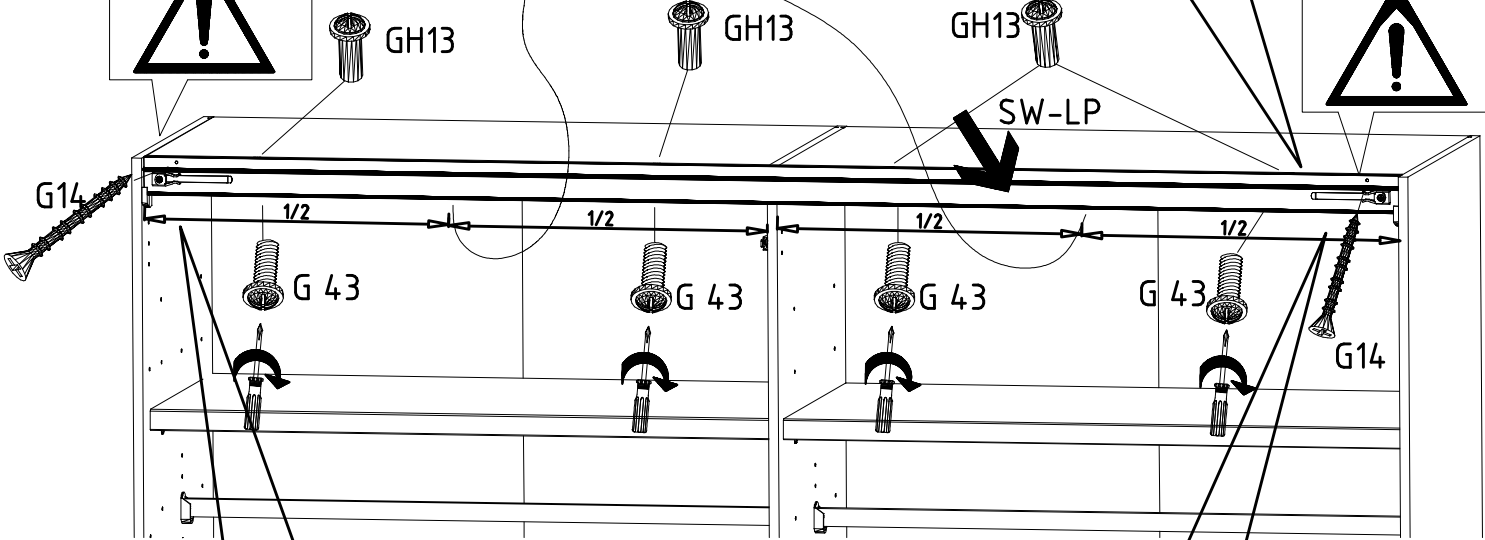
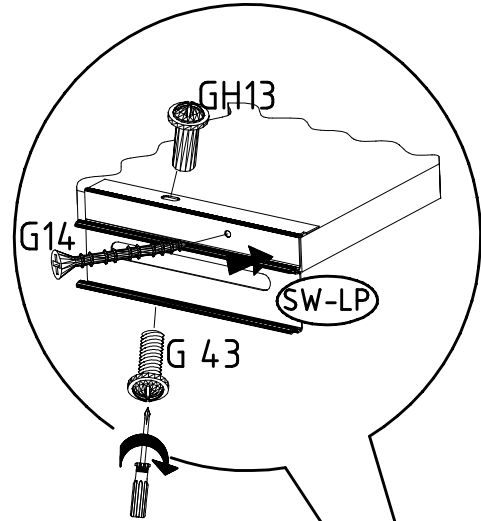
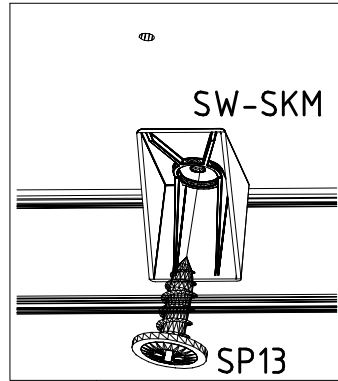
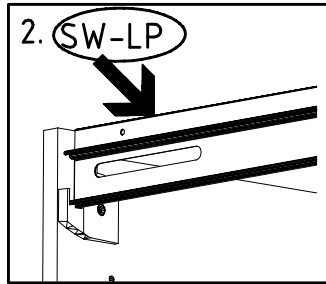
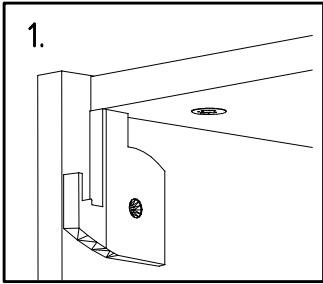
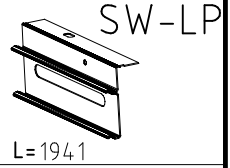
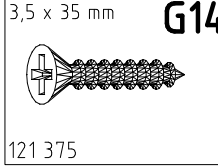
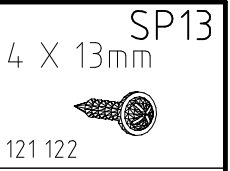
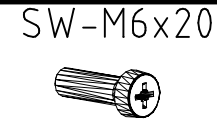
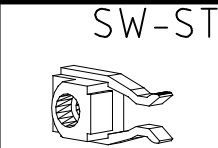
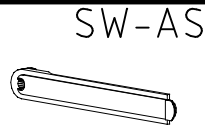
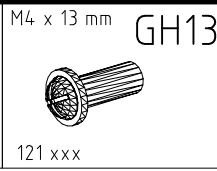
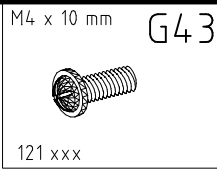

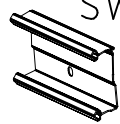
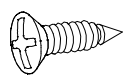
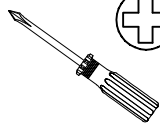

|   |   |   |
|---|---|---|
|  <p>SW-FP<br/>L=1941</p> | <p>3,5 x 15 mm G1</p>  <p>121 370</p> |   |
|---|---|---|

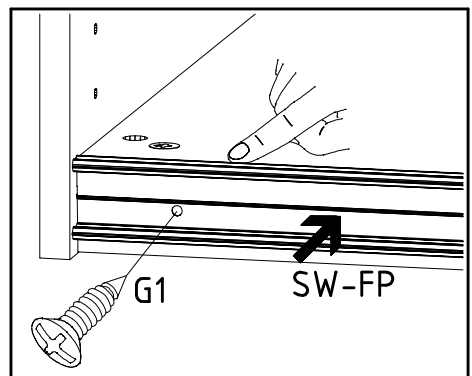
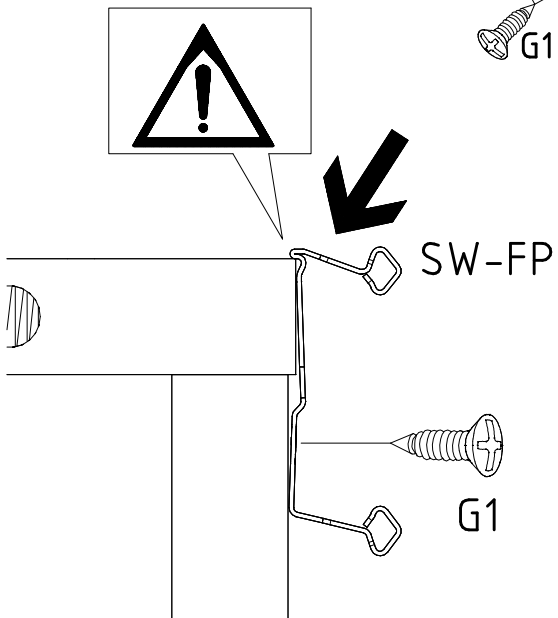
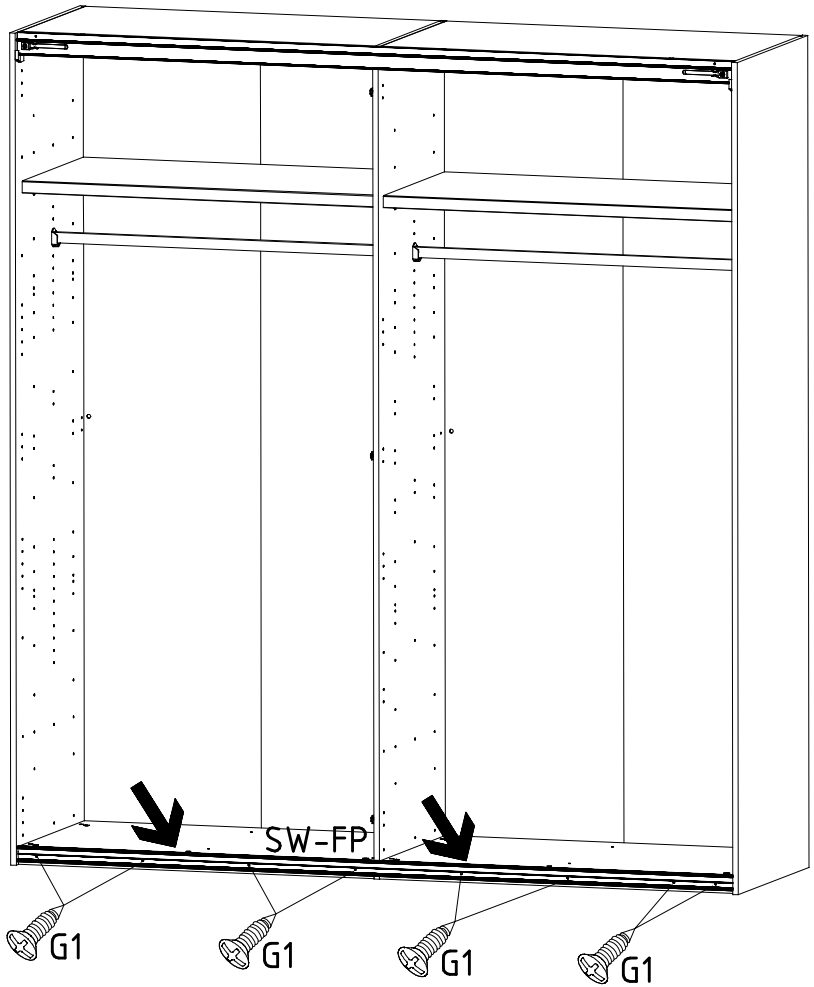



12

I.

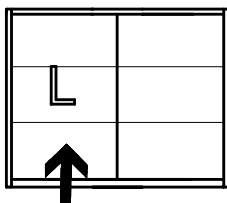
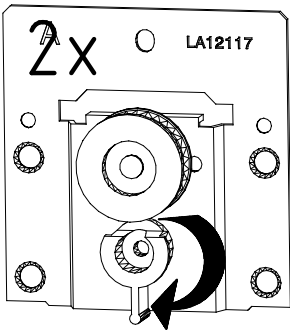

II.

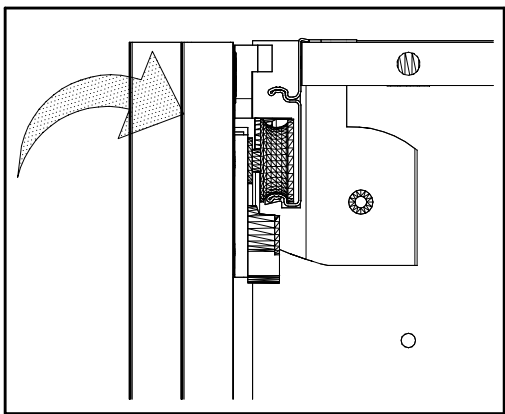
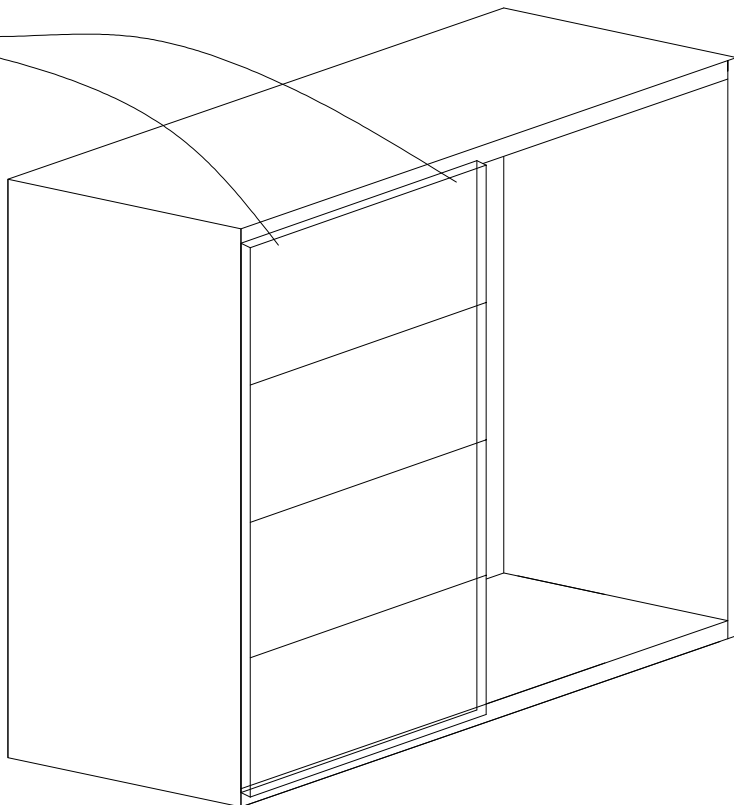
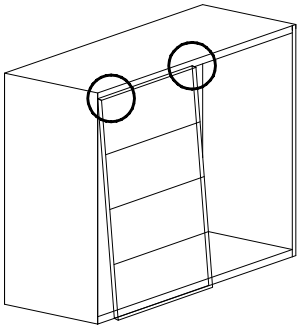

III.

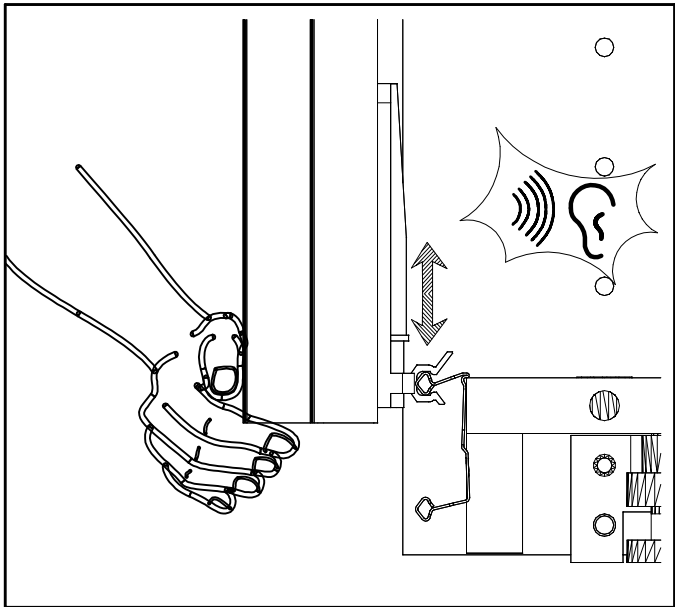
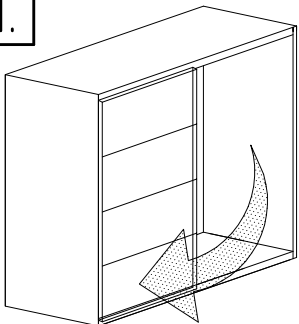

IV.

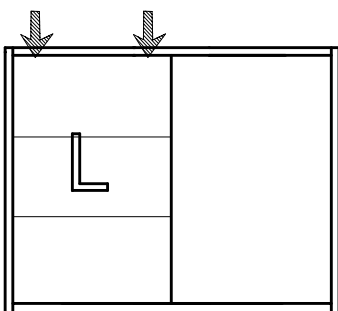
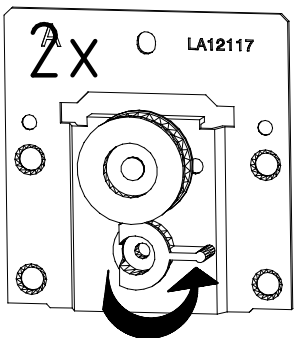

13

I.

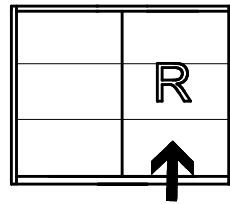
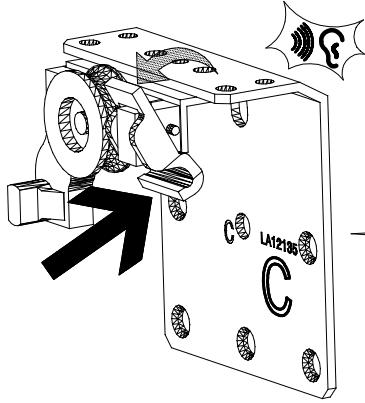

2x

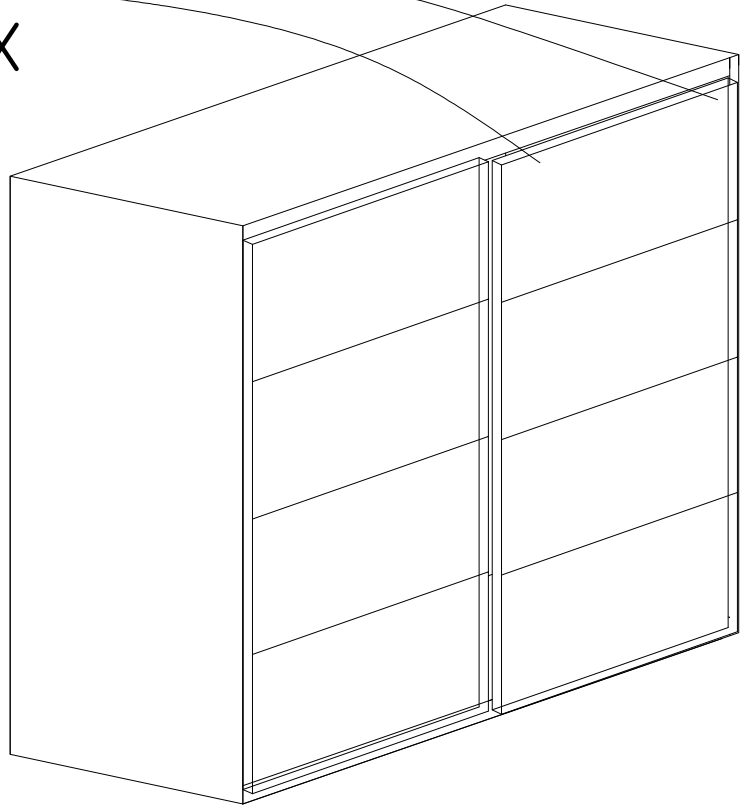

II.

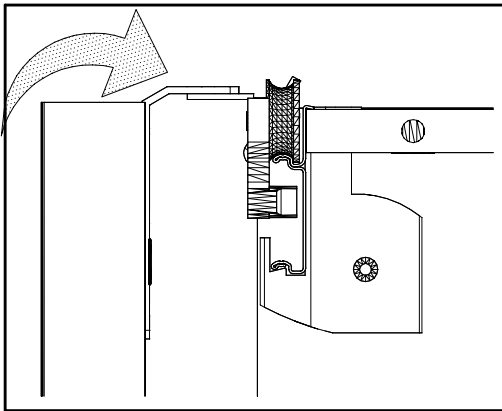
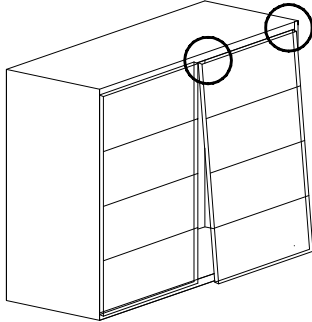

III.

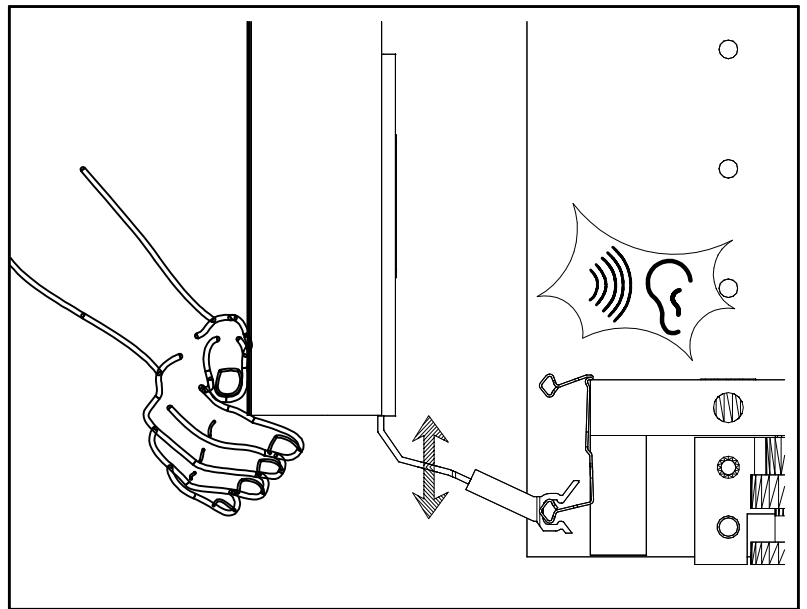
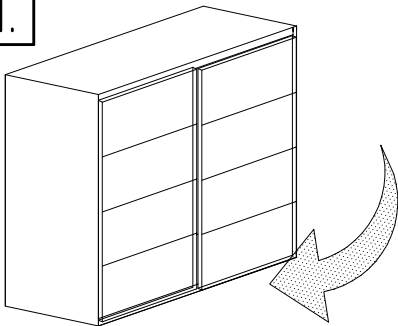

IV.

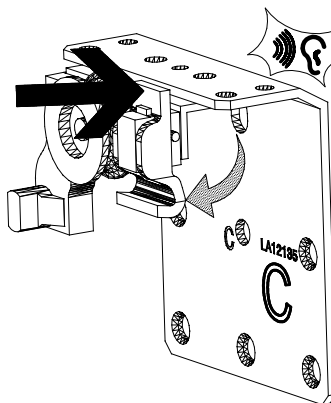

2x

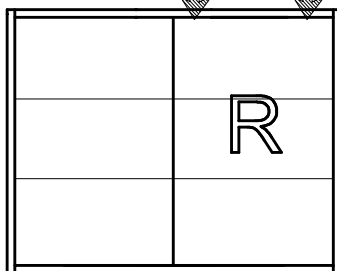

14

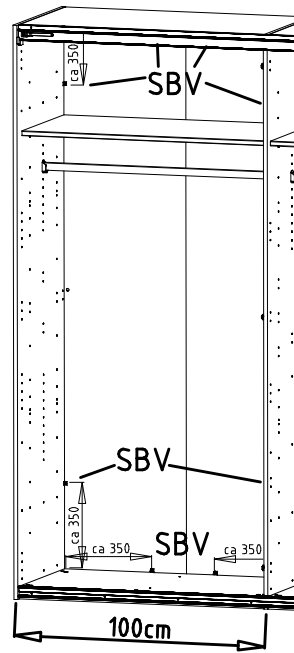
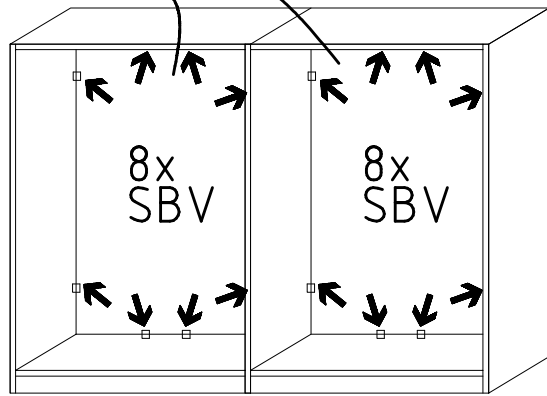
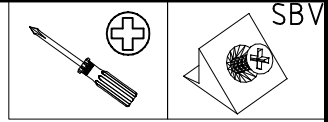
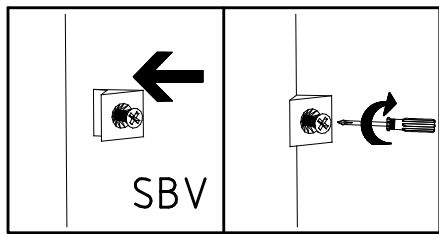

15

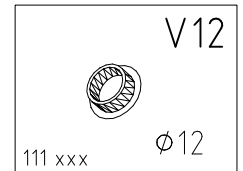
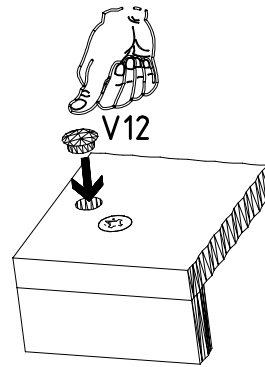
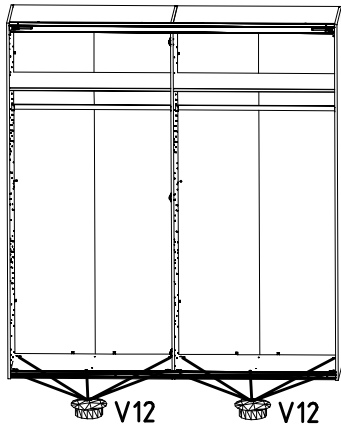

16

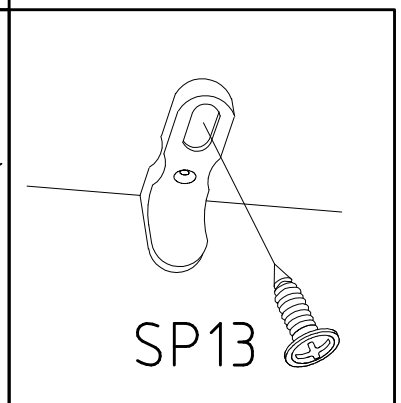
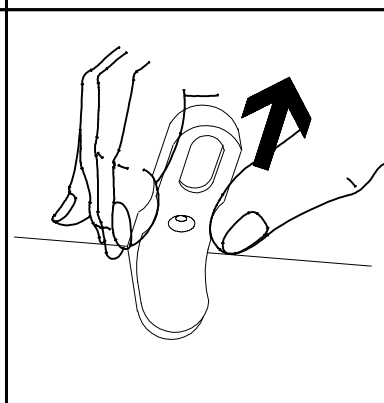
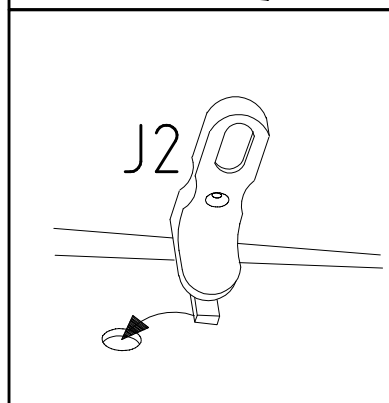
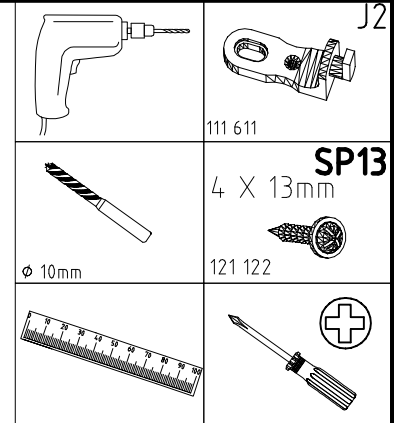
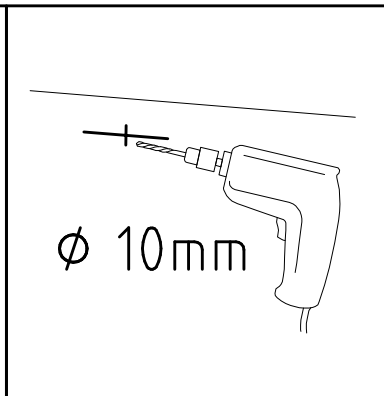
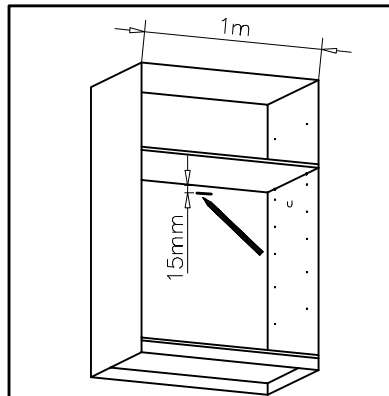

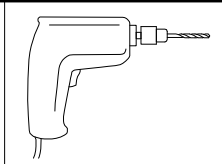

ø 8mm

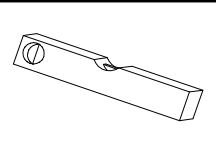
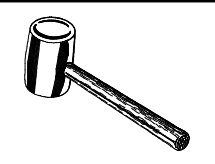

SP15  
4 X 15mm  
121 120

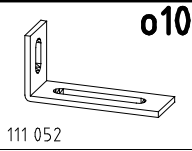

ø10

111 052

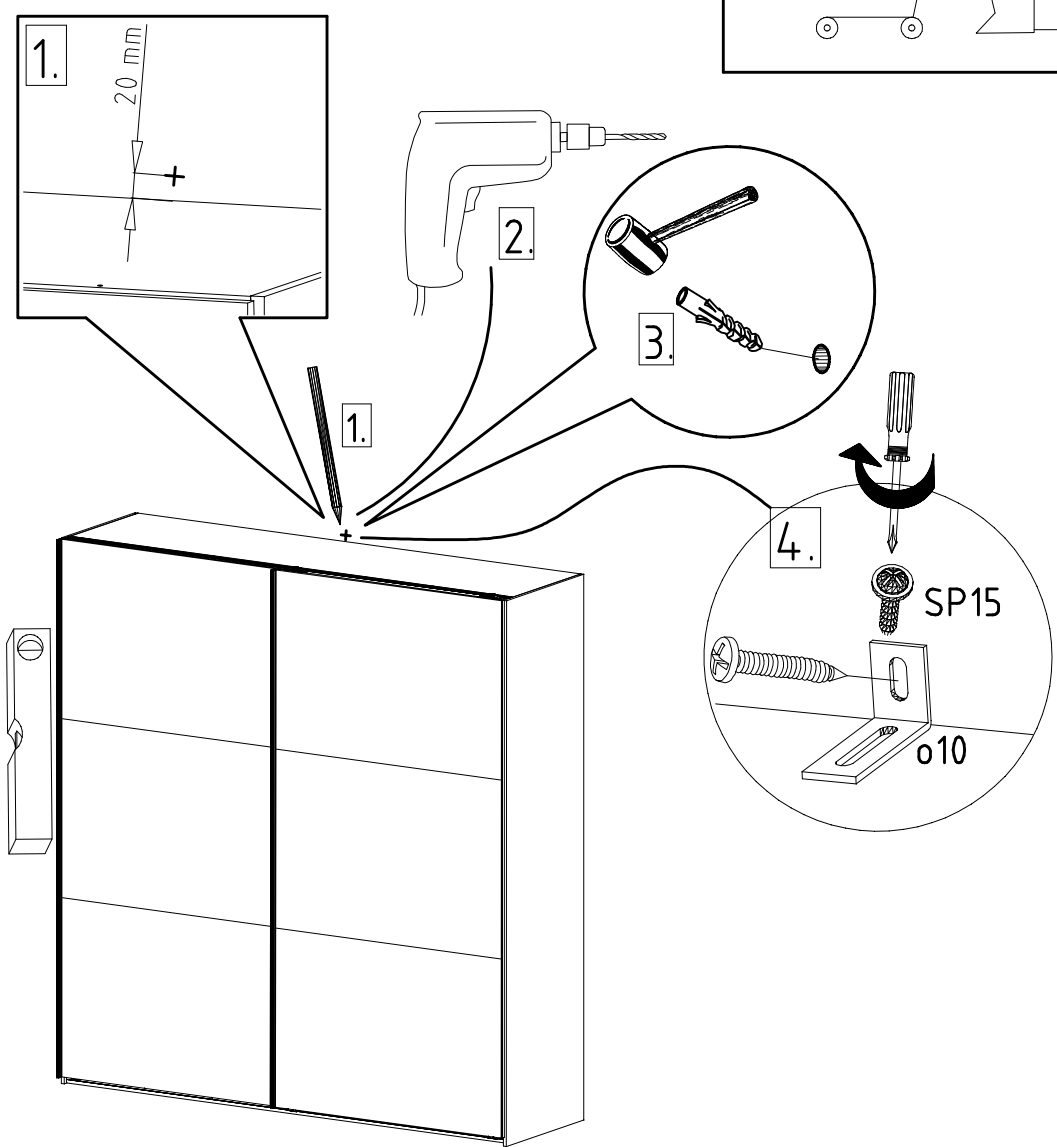
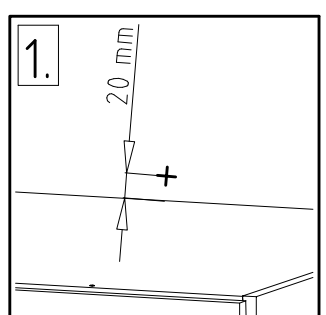
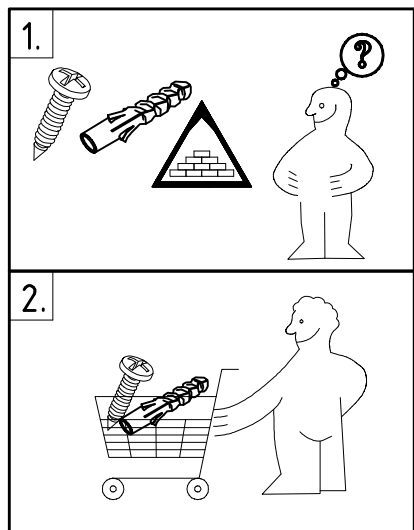

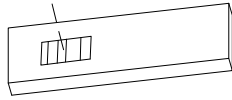
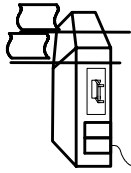
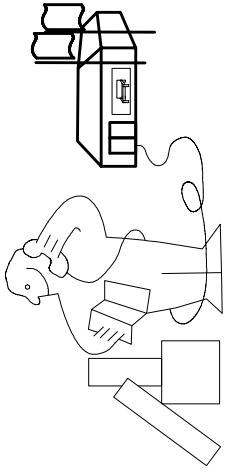
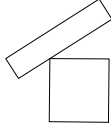
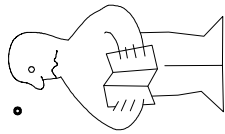

Modell/Modèle

□ □ □ □

\_\_\_\_\_  
\_\_\_\_\_  
\_\_\_\_\_



□ □ □ □ □ □ □ □ □ □

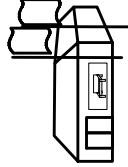

\_\_\_\_\_  
\_\_\_\_\_  
\_\_\_\_\_  
\_\_\_\_\_

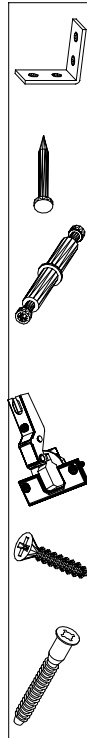

|           |         |      |
|-----------|---------|------|
| <121 370> | < G 1 > | <4x> |
|           |         |      |
|           |         |      |
|           |         |      |
|           |         |      |

Änderungen die dem technischen Fortschritt geschuldet sind, behalten wir uns vor!  
Bei nicht vorschriftsmäßiger und/ oder nicht fachmännischer Montage wird bei Personen- und/ oder Sachschäden keinerlei Haftung übernommen.

made by

WIMEX Wohnbedarf Import Export Handels GmbH & CoKG/ Postfach 1407/ 49112 Georgsmarienhütte/ Germany

|  |                                |
|--|--------------------------------|
| 23203  | 30110XY                        |
| Kunde / Customer / Client: MAX MUSTERMANN  |                                |
| Kommission / your order reference / votre reference: 3377 MINDEN                                     |                                |
| Dekor / Decor: F99   |                                |
| Modell / Model: <b>SAMPLE</b>  |                                |
| F99842 SCHWEDLUEBENSCHRANK 250 CM H 216CM<br>PLANKENEICHE NB + RAU STEEL<br>PLANKENEICHE NACHBILDUNG |                                |
| 414760   |                                |
| SOCKEL   |                                |
| Paket / Package / Paquet: 1 von 8  | Colli / Commission: 10         |
| HSP-SWT BOD 50 TEXT/TEX SOCKEL 32 FRESH<br>SO-BOD TEXT RASTEX/ ZWBOD D18MM 1X KLSTA                  |                                |
| Montage - Anleitung: KS-64   | Laenge: 520,0<br>Breite: 568,0 |
| SOCKEL32 KLEB  |                                |



104 OBEREN 5 30/19 HAUT ROYEN 11. ABOVE OBEREN

23.08.19



|                                       |   |
|---------------------------------------|---|
| <b>WIMEX Wohnbedarf</b>               |   |
| Import Export Handelsges mbH & Co. KG |   |
| Werner-von-Siemens-Str. 35            |   |
| D-49124 Georgsmarienhütte - Germany   |   |
| <b>SAMPLE</b>                         | <b>23.08.19</b>                         |
| Modellname<br>Model                   | Produktionsdatum<br>Date of manufacture |

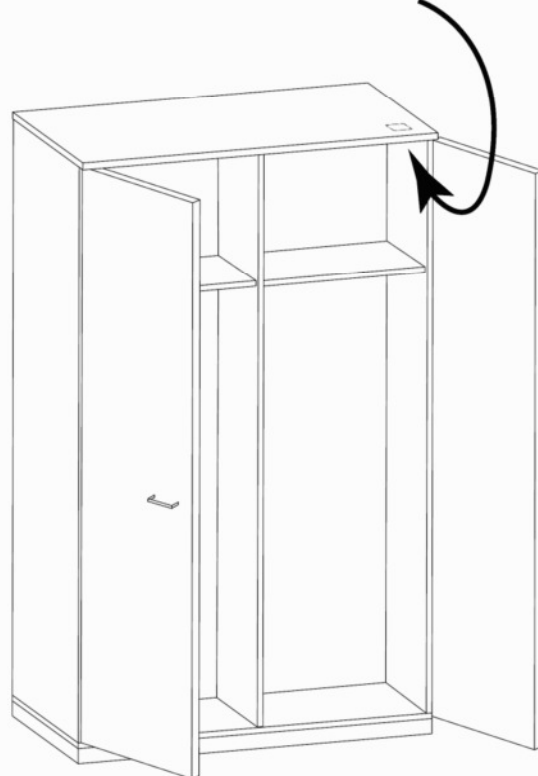
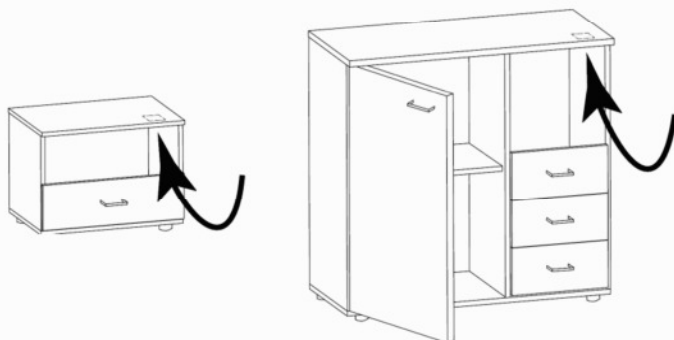
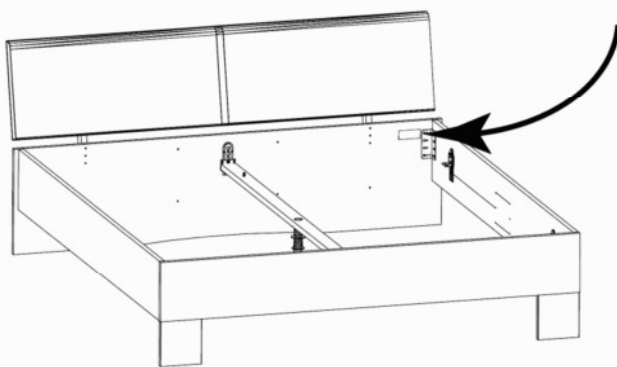

980740

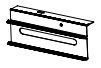

1.



2.

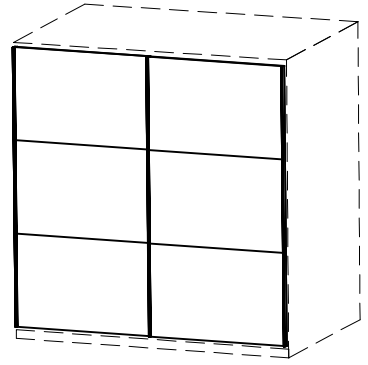
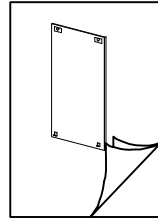
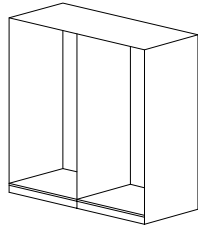
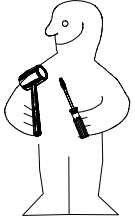

150/200/250/300 HSP

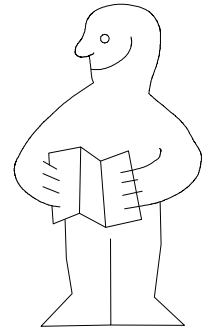
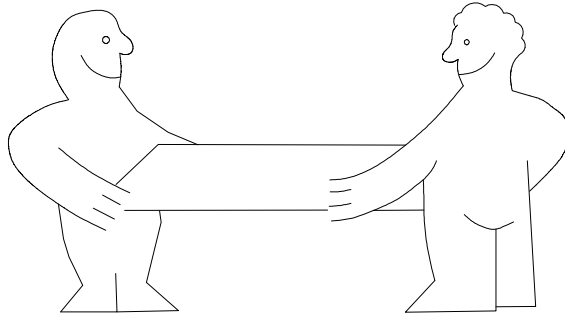
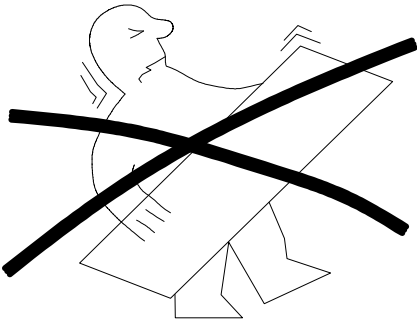



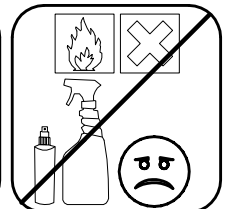
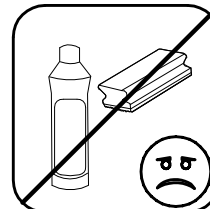
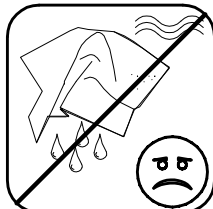
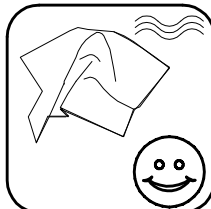
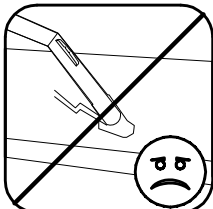
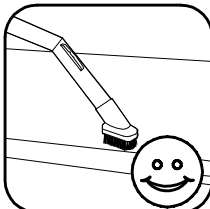
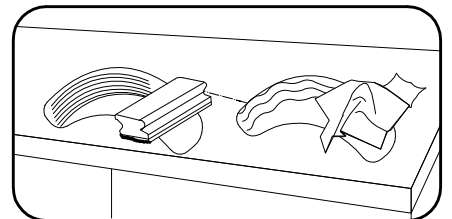
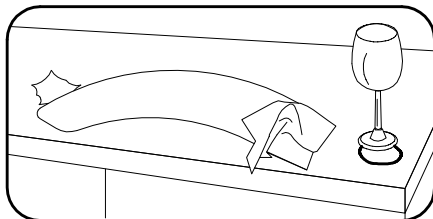
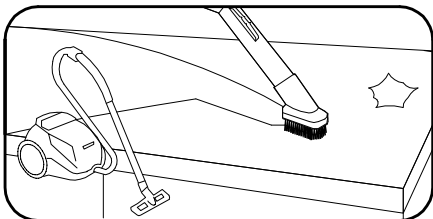
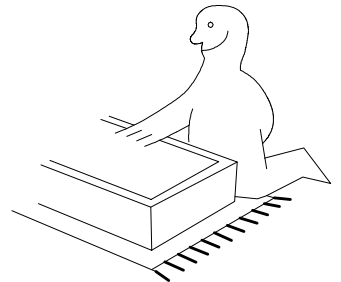
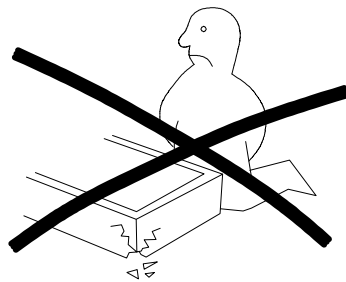
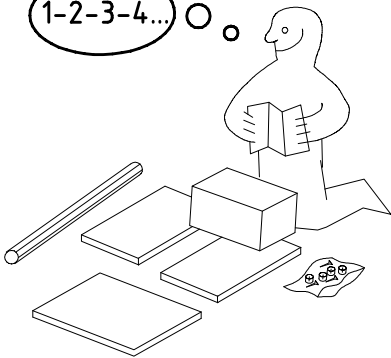

1-2-3-4... ○ ○





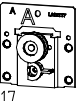

980740

19.05.24 / -

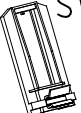
05 24 | 1/7

|   |    |
|---|----|
| SW-LA<br><br>LA12117 | 1x |
| SW-LB<br><br>LA12116 | 1x |
| SW-LC<br><br>LA12135 | 1x |
| SW-LD<br><br>LA12175 | 1x |

|  |    |
|--|----|
| SW-F1<br> | 4x |
| SW-F2<br> | 2x |
| SW-F3<br> | 2x |

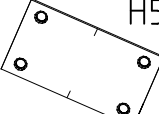
|  |     |
|--|-----|
| 4 X 13mm<br><br>121 122         | 64x |
| 6,3 x 10,5 mm T2<br><br>111 030 | 26x |
| H5<br><br>114 183               | 4x  |

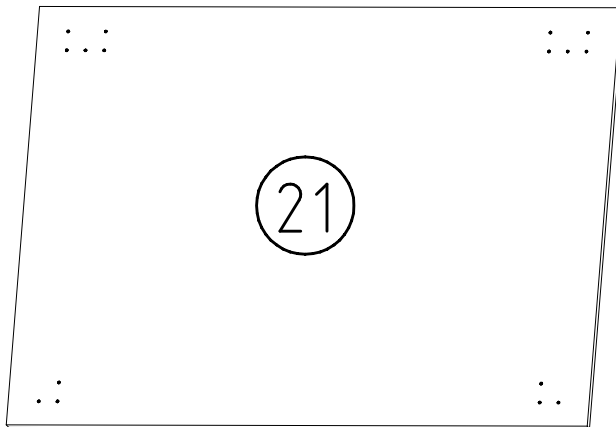
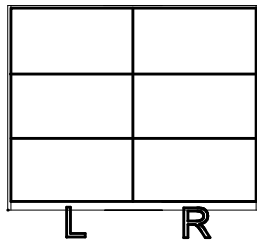
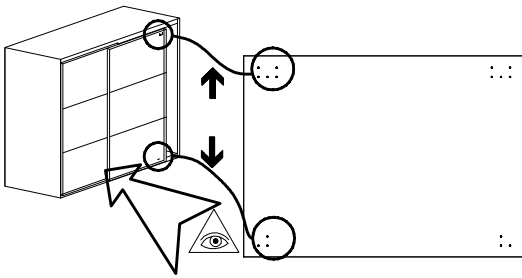
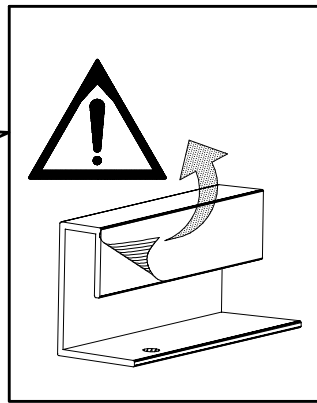
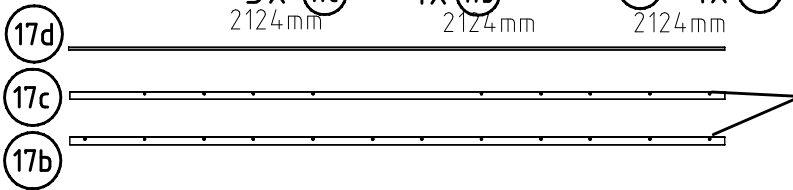
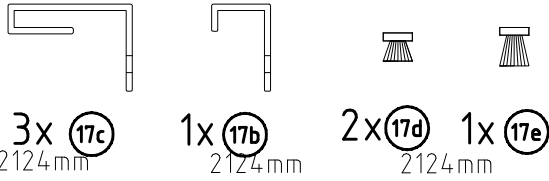
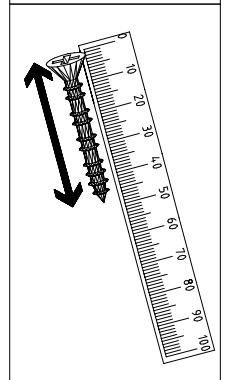
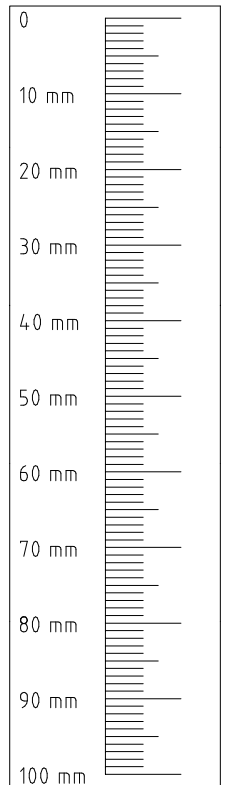
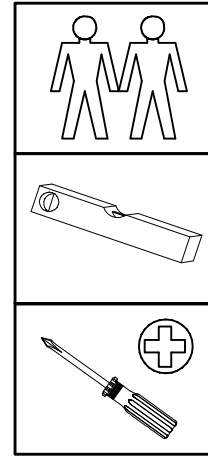

6x 745/990/1235/1485 x 708 x 15



1

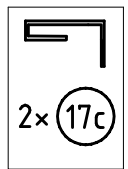
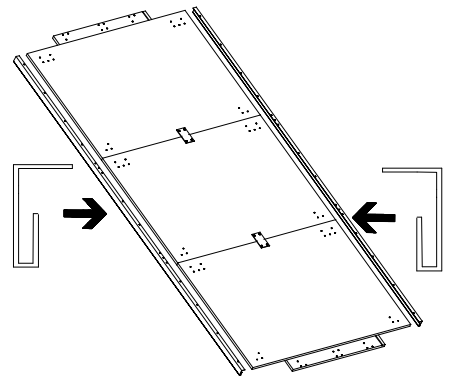
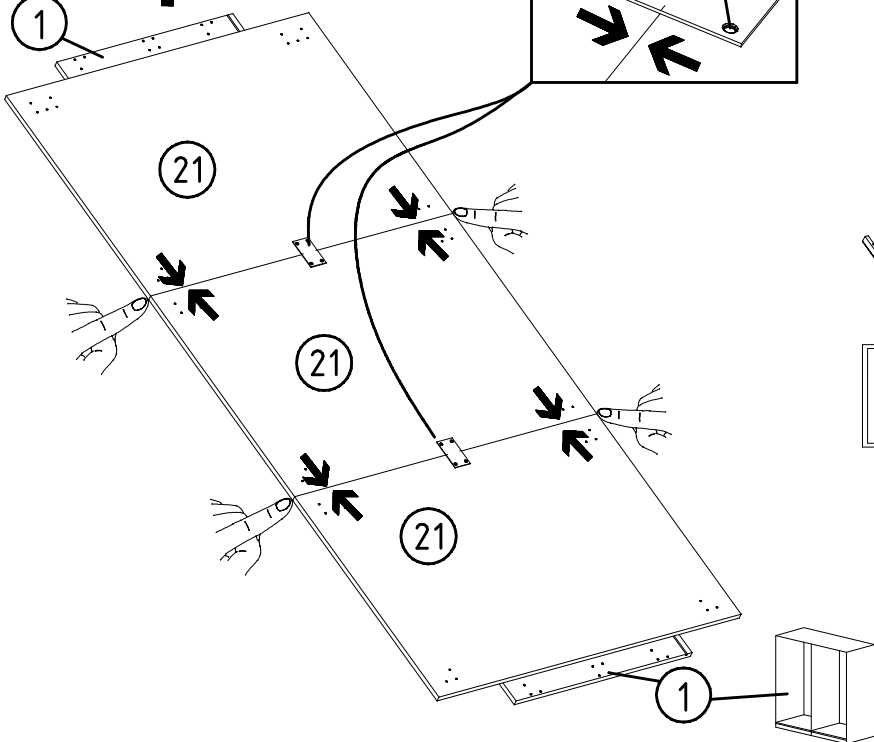
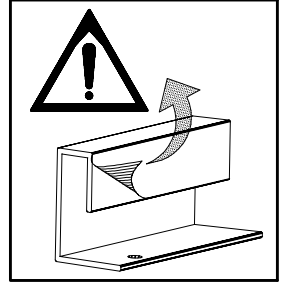
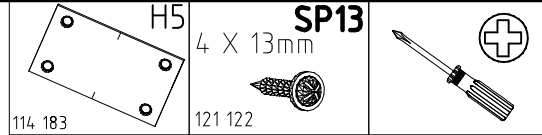
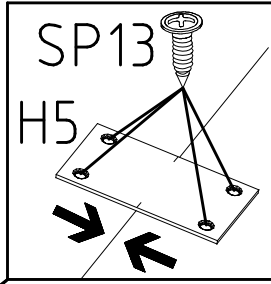
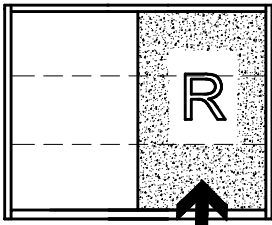

2

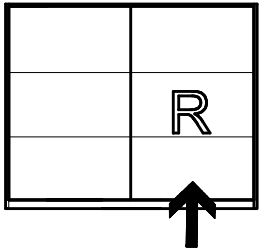
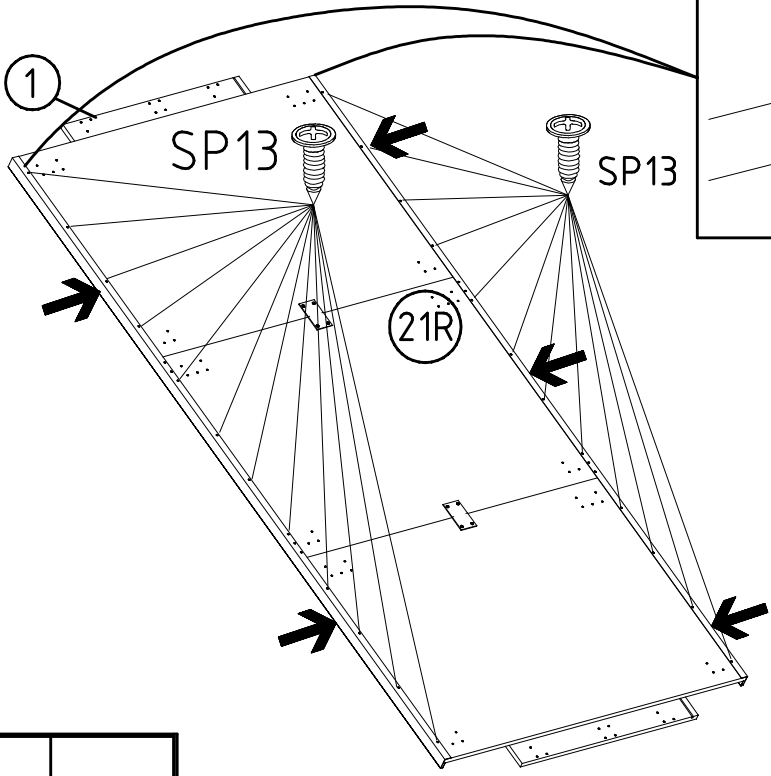
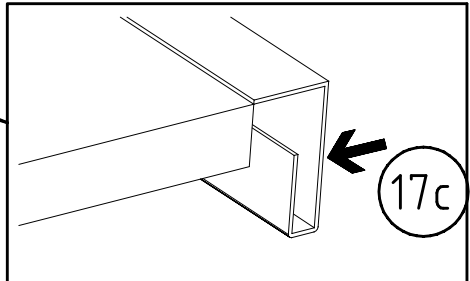

3

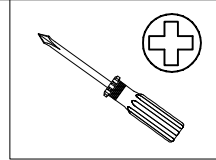
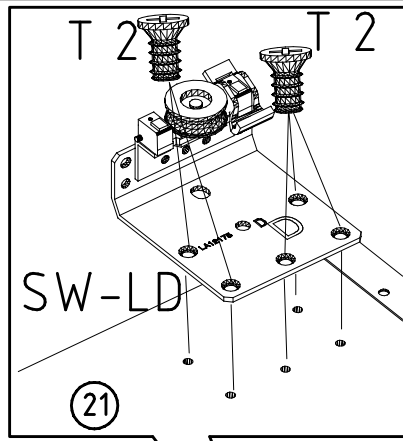
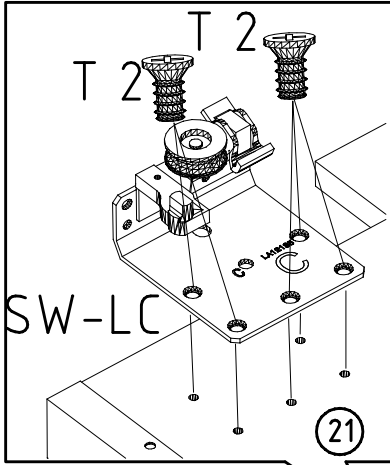

6,3 x 10,5 mm T2

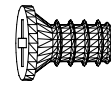

111 030 LA12135

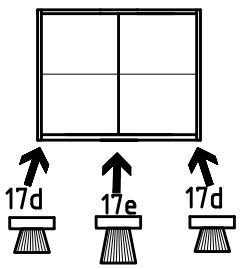
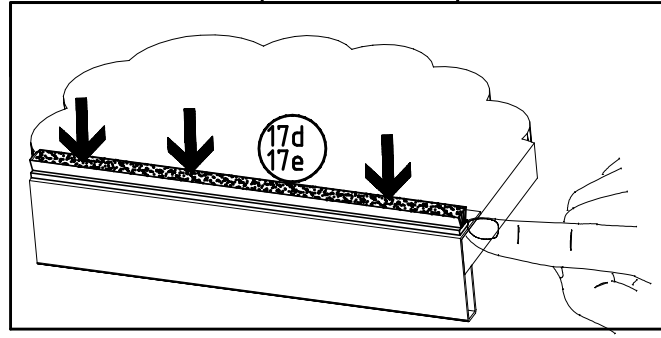
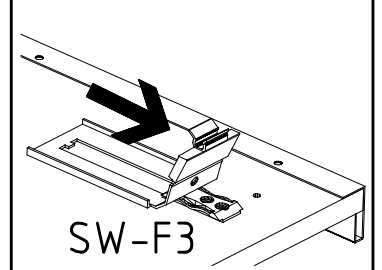
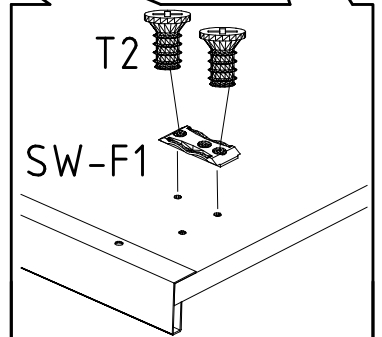
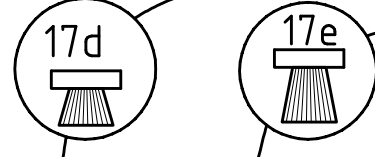
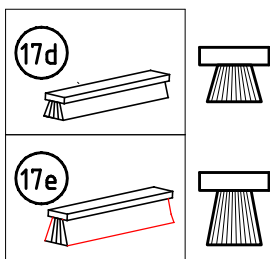
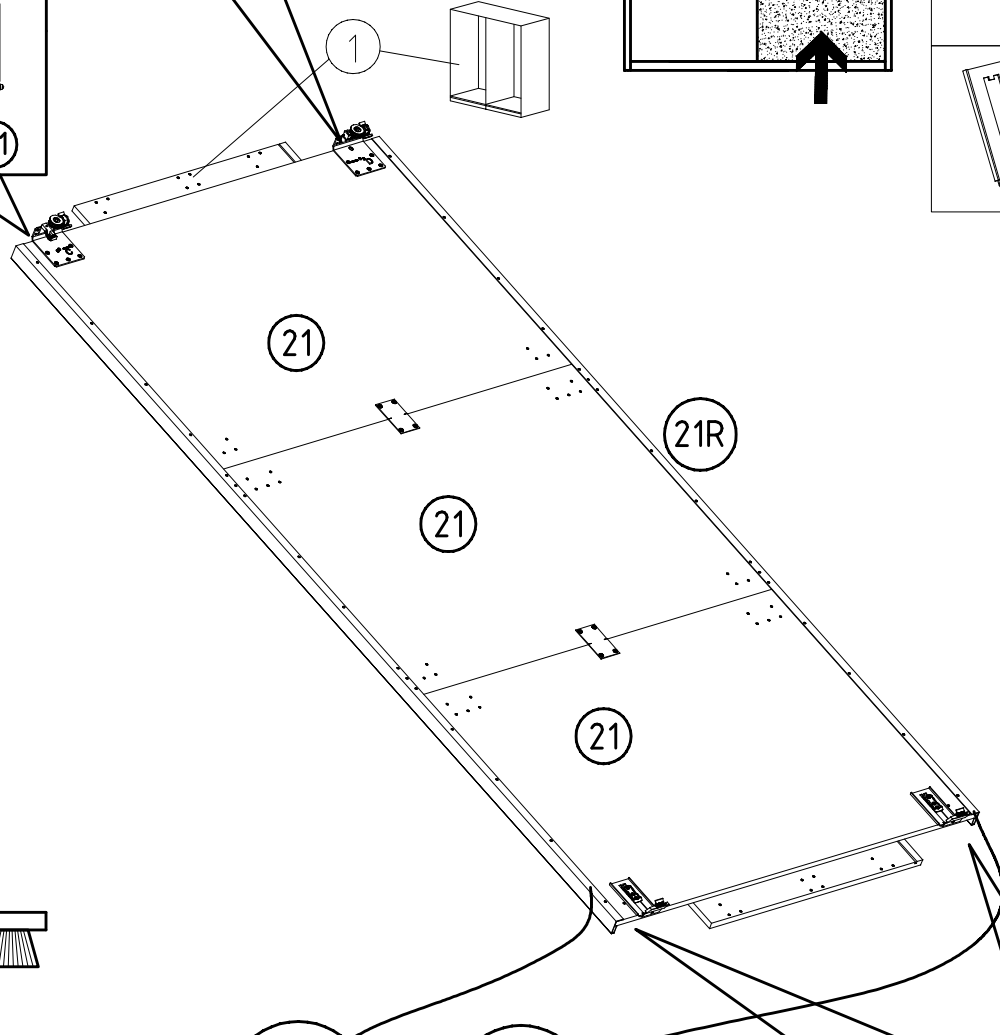
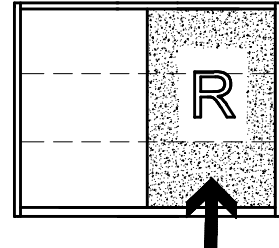
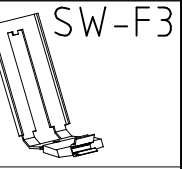
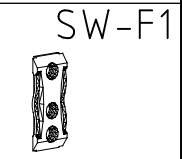
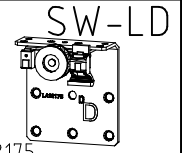
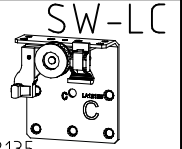

4

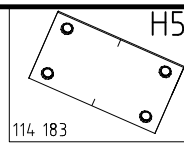
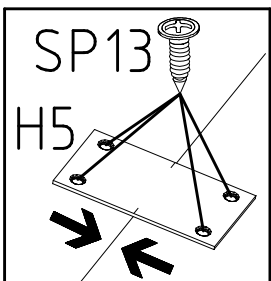
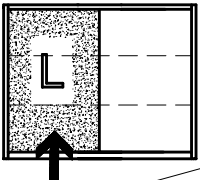

4 X 13mm  
SP13  
121 122

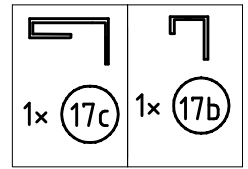
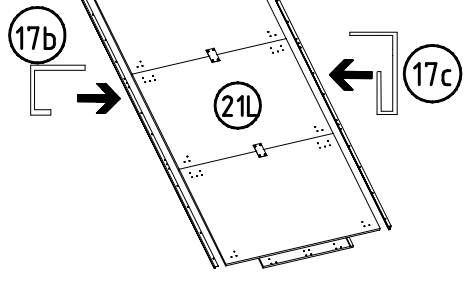
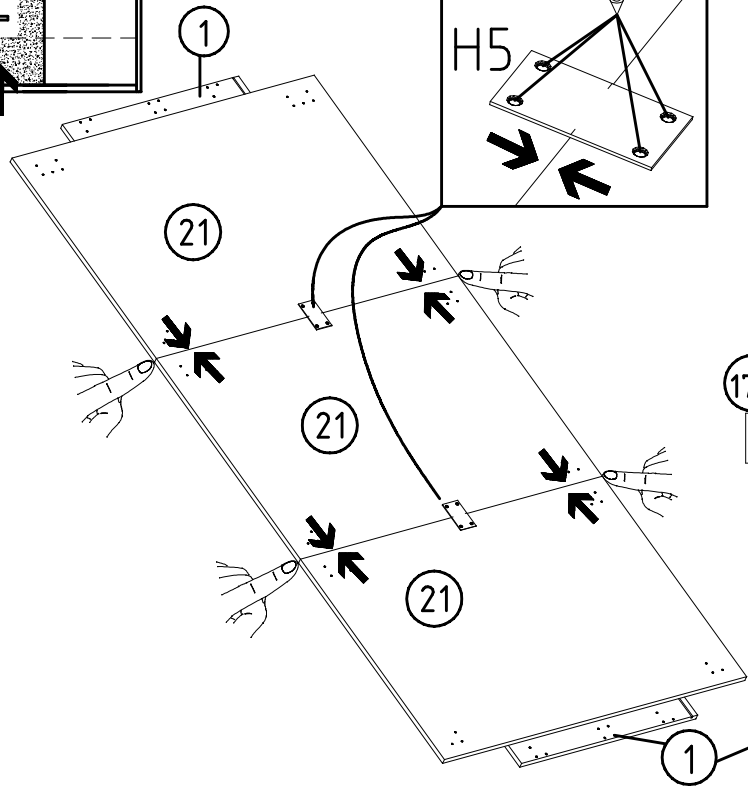
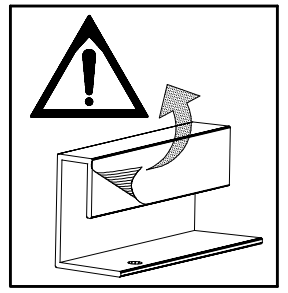
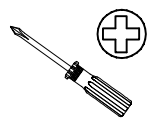

5

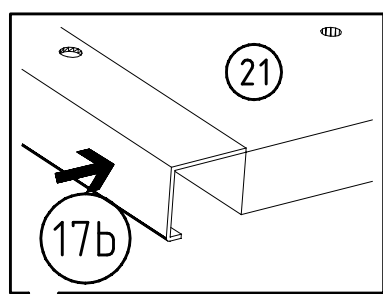

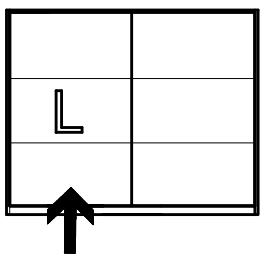
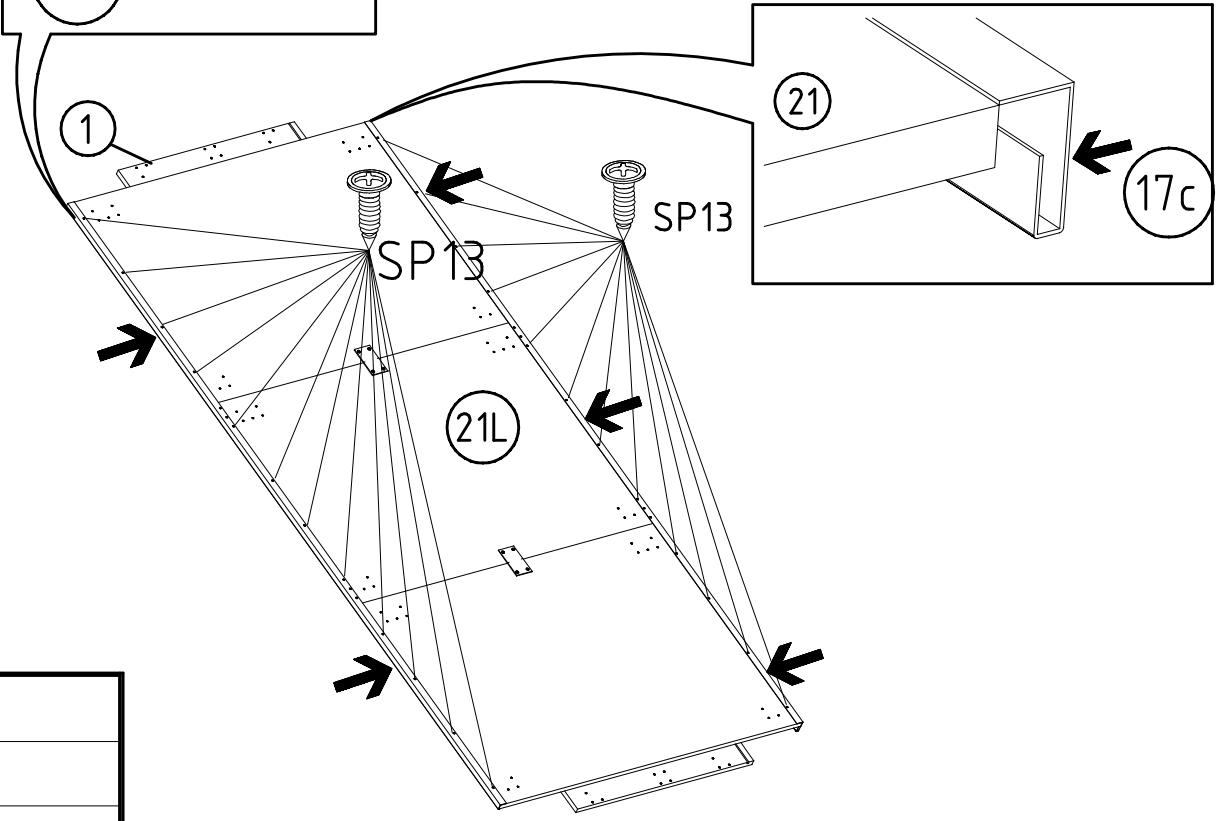
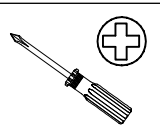

4 X 13mm  
SP13  
121 122



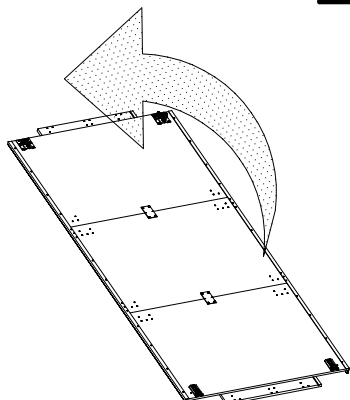
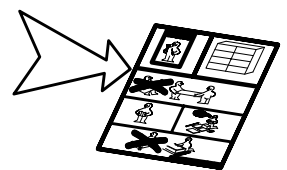
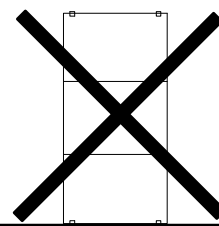
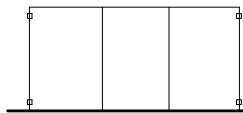
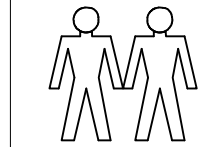
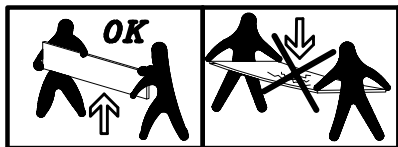
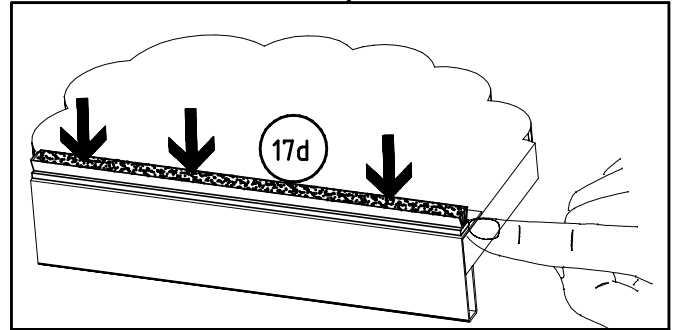
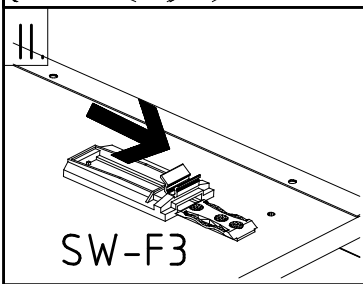
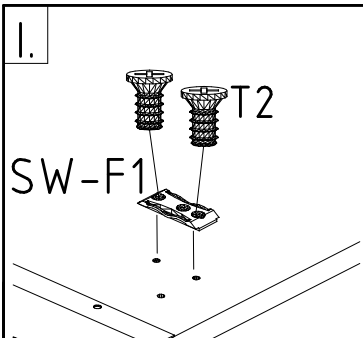
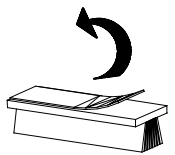
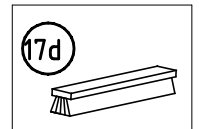
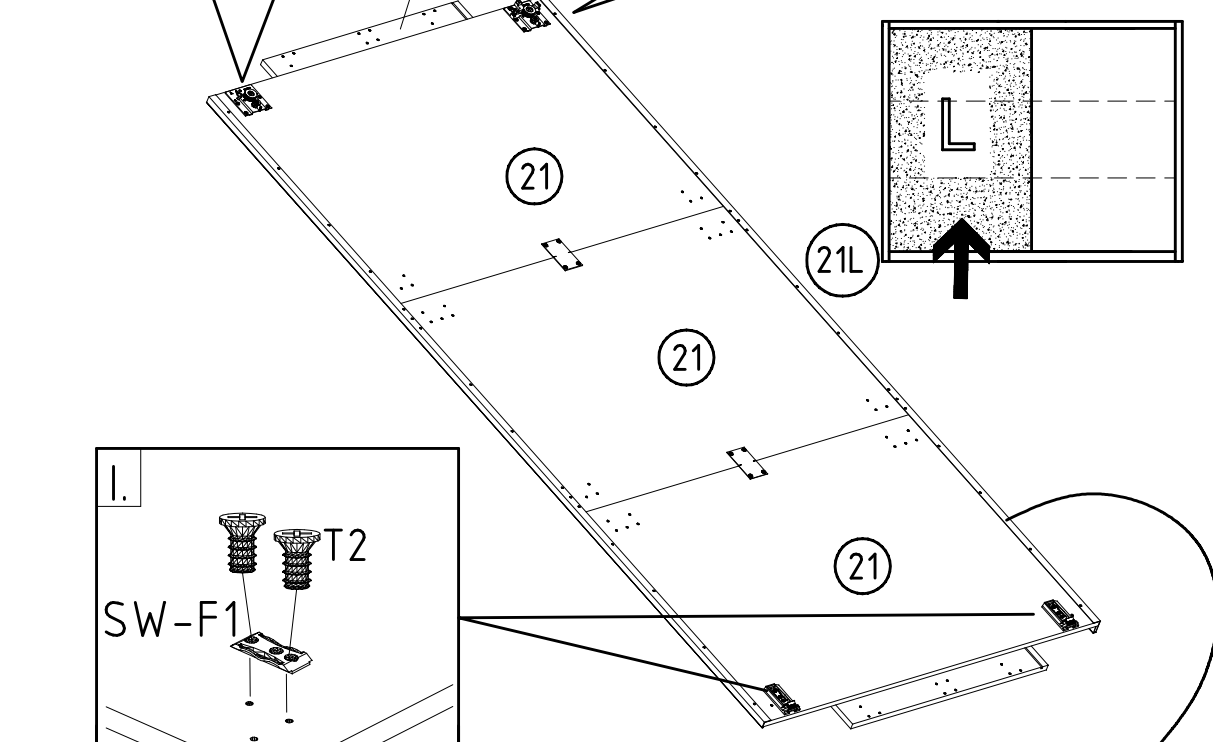
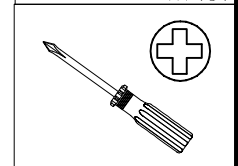
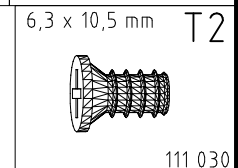
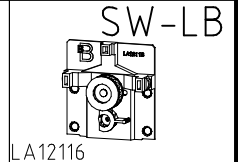
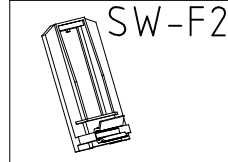
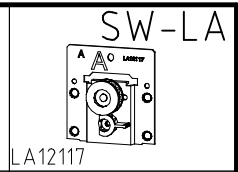
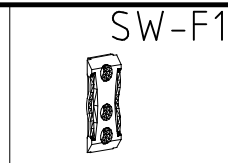
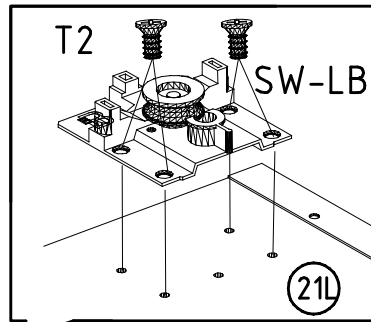
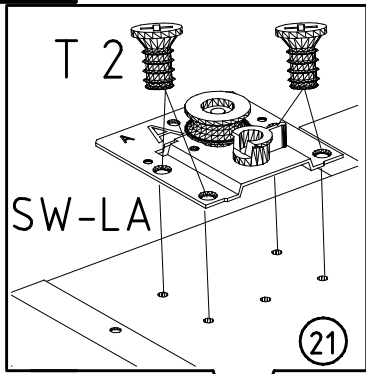

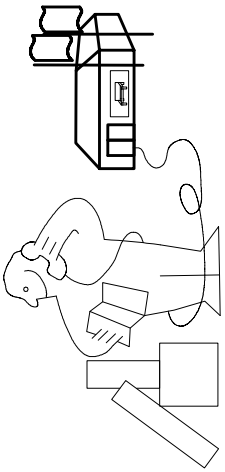
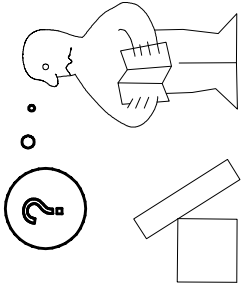
6

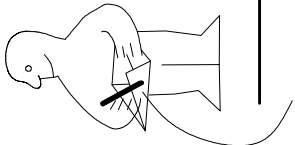
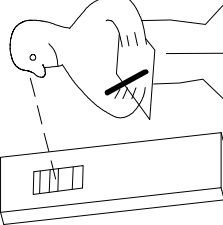



Modell/Modèle \_\_\_\_\_  
 \_\_\_\_\_  
 \_\_\_\_\_  
 \_\_\_\_\_

\_\_\_\_\_  
 \_\_\_\_\_  
 \_\_\_\_\_

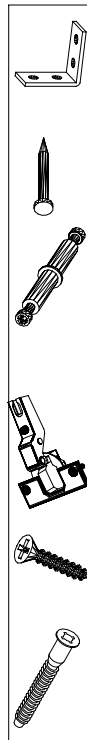

|           |         |      |
|-----------|---------|------|
| <121 370> | < G 1 > | <4x> |
|           |         |      |
|           |         |      |
|           |         |      |
|           |         |      |

Änderungen die dem technischen Fortschritt geschuldet sind, behalten wir uns vor!  
 Bei nicht vorschriftsmäßiger und/ oder nicht fachmännischer Montage wird bei Personen-  
 und/ oder Sachschäden keinerlei Haftung übernommen.