

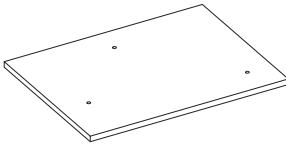

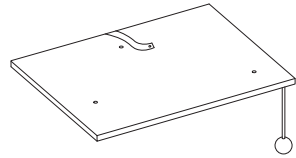

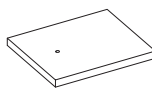

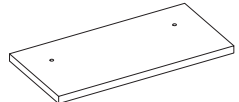

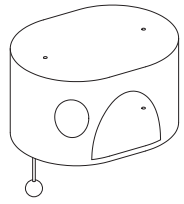
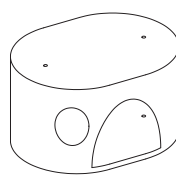

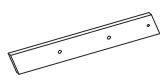
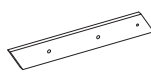

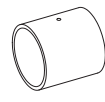







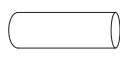



**INSTRUCTION MANUAL/BEDIENUNGSANLEITUNG/NOTICE D'UTILISATION/  
MANUAL DE INSTRUCCIONES DE USO/MANUALE DI ISTRUZIONI**  
**PARTS LIST/STÜCKLISTE/PARTS LIST/LISTA DE PIEZAS/LISTA DEI PEZZI**

<p>Pos.19</p>  <p>60x45cm 1pc</p>	<p>Pos.17</p>  <p>60x45cm 1pc</p>	<p>Pos.20</p>  <p>30x25cm 1pc</p>	<p>Pos.14</p>  <p>53x25cm 1pc</p>			
<p>Pos.15a</p>  <p>46x36x25cm 1pc</p>	<p>Pos.15b</p>  <p>46x36x25cm 1pc</p>	<p>Pos.15-1</p>  <p>22.5cm 4pcs</p>	<p>Pos.16</p>  <p>2pcs</p>			
<p>Pos.21</p>  <p>6x43cm 2pcs</p>	<p>Pos.25</p>  <p>6x40cm 2pcs</p>	<p>Pos.22</p>  <p>4x16cm 4pcs</p>	<p>Pos.18</p>  <p>18cm 1pc</p>	<p>Pos.9</p>  <p>40cm 2pcs</p>	<p>Pos.12a</p>  <p>52cm 1pc</p>	
<p>Pos.11</p>  <p>25cm 1pc</p>	<p>Pos.6</p>  <p>30cm 2pcs</p>	<p>Pos.10</p>  <p>35cm 1pc</p>	<p>Pos.8</p>  <p>40cm 4pcs</p>	<p>Pos.7</p>  <p>46cm 1pc</p>	<p>Pos.12</p>  <p>52cm 1pc</p>	
<p>P1</p>  <p>1pc</p>	<p>P2</p>  <p>1pc</p>	<p>P3</p>  <p>M10x300mm 1pc</p>	<p>P4</p>  <p>2pcs</p>	<p>Q</p>  <p>M10x75mm 14pcs</p>	<p>R1</p>  <p>4pcs</p>	<p>R2</p>  <p>M6x16mm 8pcs</p>
<p>S</p>  <p>M8x40mm 8pcs</p>	<p>T</p>  <p>M10x20mm 1pc</p>	<p>U</p>  <p>M10x40mm 2pcs</p>	<p>V1</p>  <p>1pc</p>	<p>V2</p>  <p>ST6x40mm 1pc</p>	<p>W1</p>  <p>S5 1pc</p>	<p>W2</p>  <p>S6 1pc</p>

RETAIN FOR FUTURE REFERENCE  
FÜR KÜNFTIGE VERWENDUNG AUFBEWAHREN  
A CONSERVARE POUR UNE UTILISATION FUTURE  
CONSERVAR PARA SER LEÍDO POR CADA NUEVO USUARIO,  
ANTES DE UTILIZAR EL ARTÍCULO POR PRIMERA VEZ  
CONSERVARE PER CONSULTAZIONI FUTURE

ASSEMBLY/MONTAGE/ASSEMBLAGE/MONTAJE/ASSEMBLAGGIO

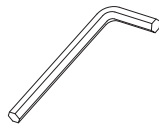
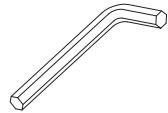

**Warning!**  
**Warnung!**  
**Attention !**  
**Atención!**  
**Avvertimento!**

Tight all the screws to 60% first then tight to 100%.  
 Während der Montage alle Schrauben zuerst 60% anziehen, dann zu 100%.  
 Serrez toutes les vis à 60% d'abord puis serrez à 100%.  
 Primero apriete los tornillos al 60% y después al 100%.  
 Stringere le viti dapprima al 60% e successivamente completamente al 100%.

1

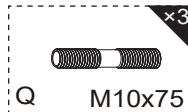
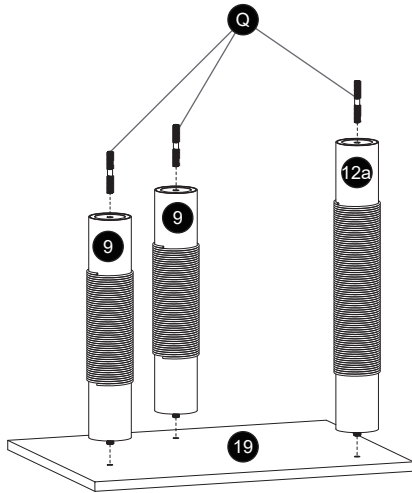

2

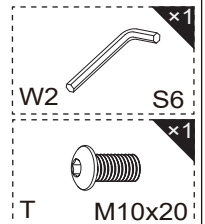
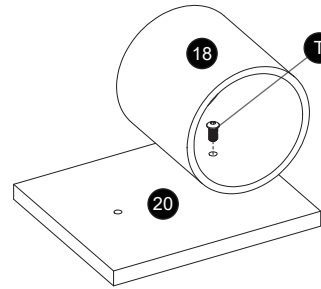

3

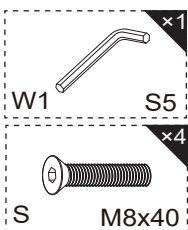
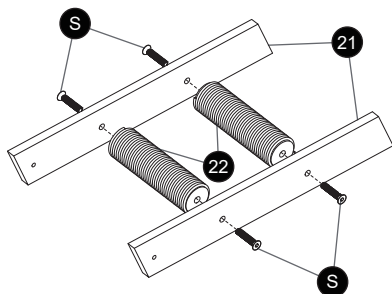

4

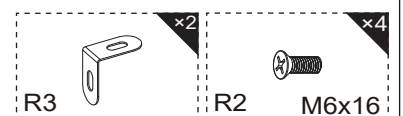
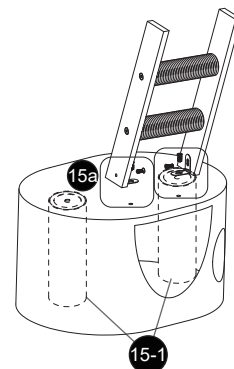
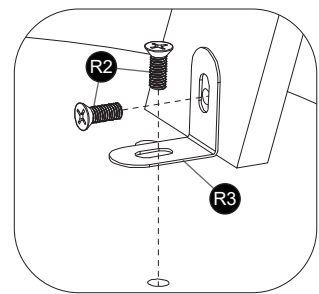



**Warning!**  
**Warnung!**  
**Attention !**  
**Atención!**  
**Avvertimento!**

Tight all the screws to 60% first then tight to 100%.  
Während der Montage alle Schrauben zuerst 60% anziehen, dann zu 100%.  
Serrez toutes les vis à 60% d'abord puis serrez à 100%.  
Primero apriete los tornillos al 60% y después al 100%.  
Stringere le viti dapprima al 60% e successivamente completamente al 100%.

5

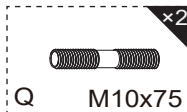
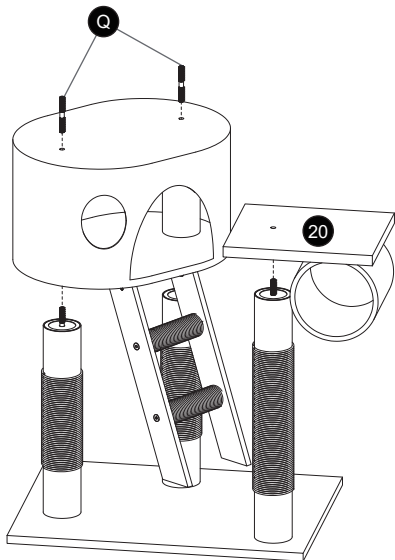

6

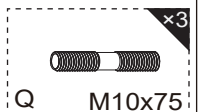
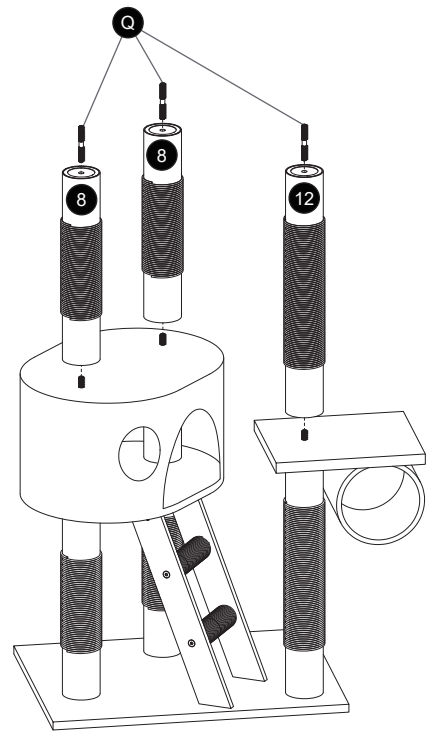

7

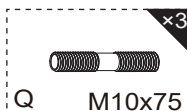
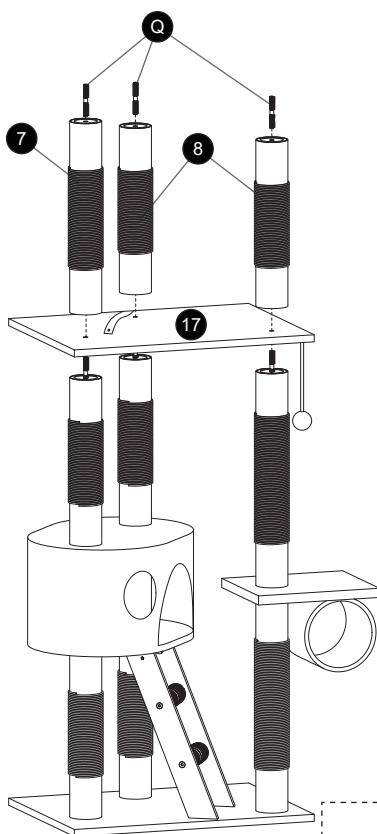

8

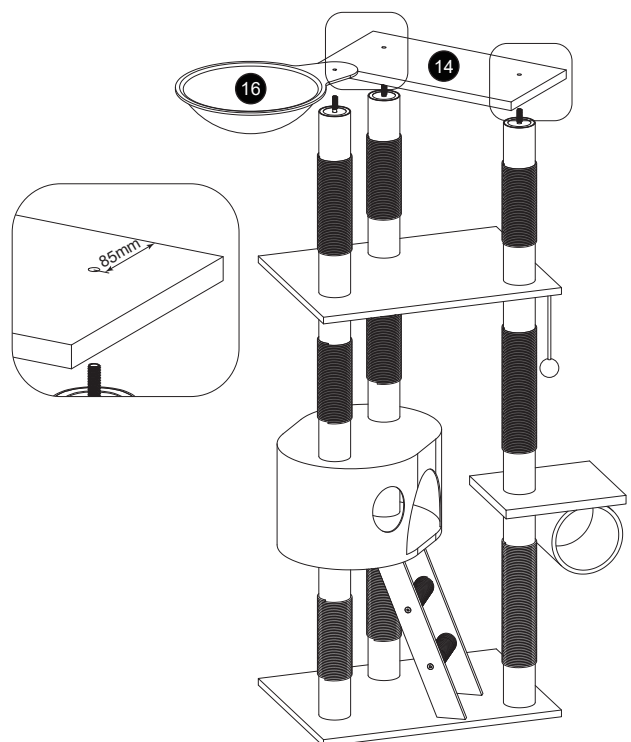



**Warning!**  
**Warnung!**  
**Attention !**  
**Atención!**  
**Avvertimento!**

Tight all the screws to 60% first then tight to 100%.  
Während der Montage alle Schrauben zuerst 60% anziehen, dann zu 100%.  
Serrez toutes les vis à 60% d'abord puis serrez à 100%.  
Primero apriete los tornillos al 60% y después al 100%.  
Stringere le viti dapprima al 60% e successivamente completamente al 100%.

9

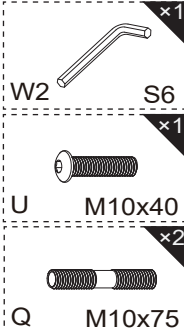
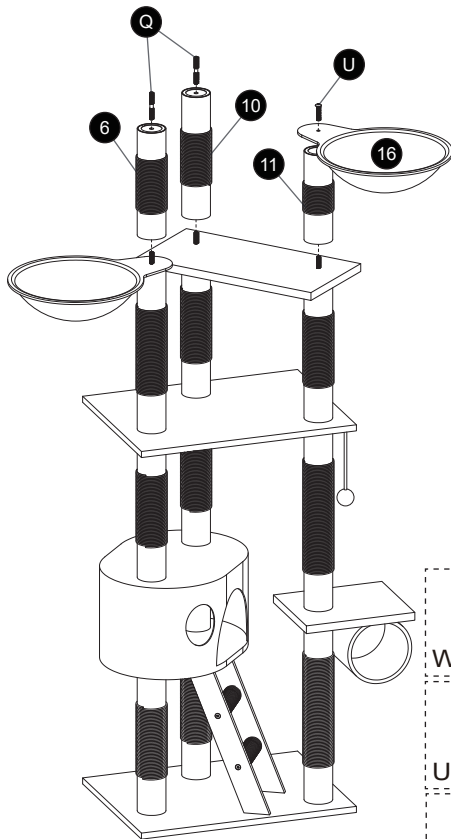

10

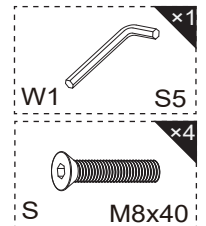
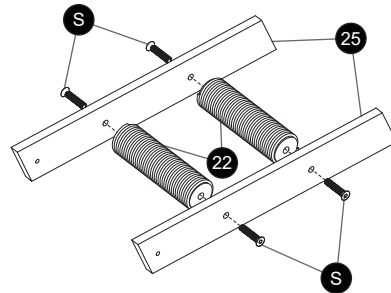

11

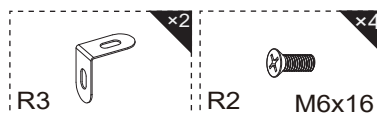
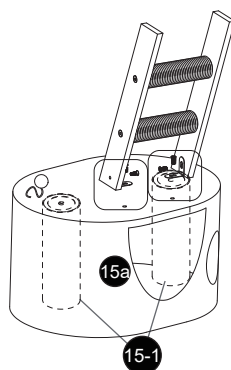
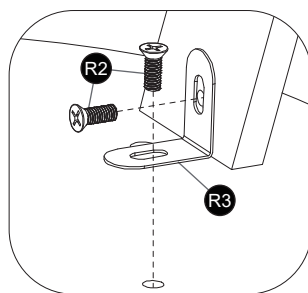

12

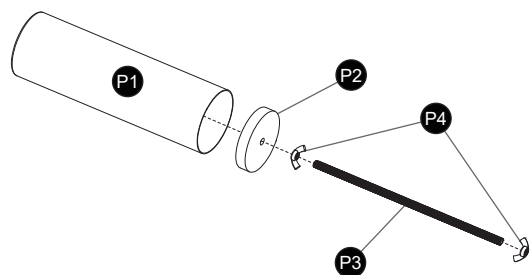



**Warning!**  
**Warnung!**  
**Attention !**  
**Atención!**  
**Avvertimento!**

Tight all the screws to 60% first then tight to 100%.  
Während der Montage alle Schrauben zuerst 60% anziehen, dann zu 100%.  
Serrez toutes les vis à 60% d'abord puis serrez à 100%.  
Primero apriete los tornillos al 60% y después al 100%.  
Stringere le viti dapprima al 60% e successivamente completamente al 100%.

13

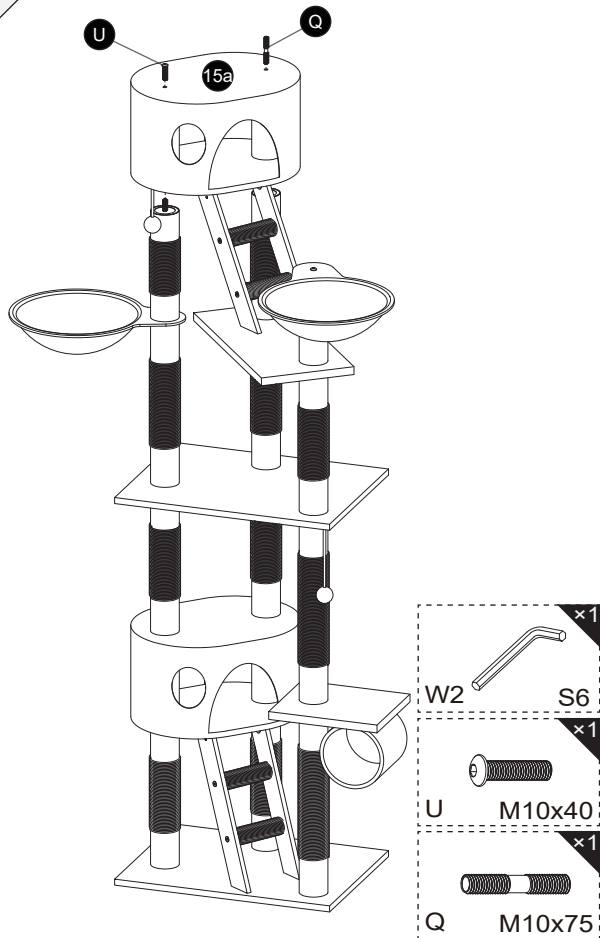

14

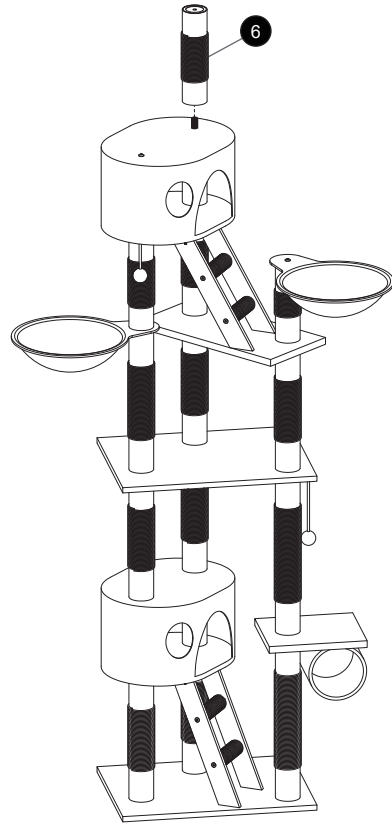

15

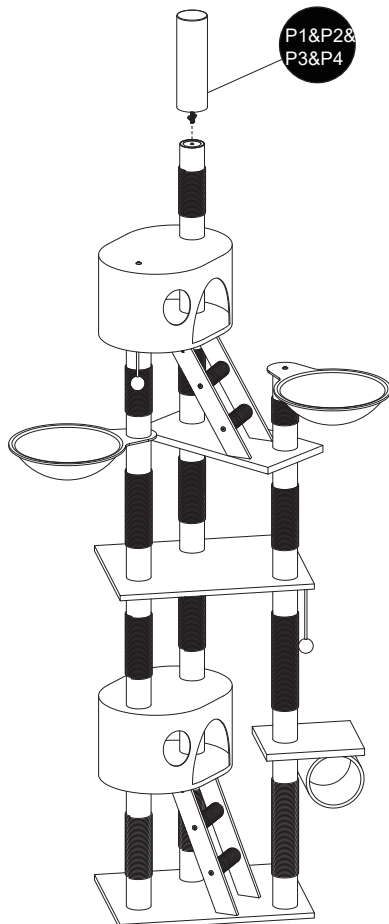

16

