

WESTMINSTER 2/ CARMEN 2

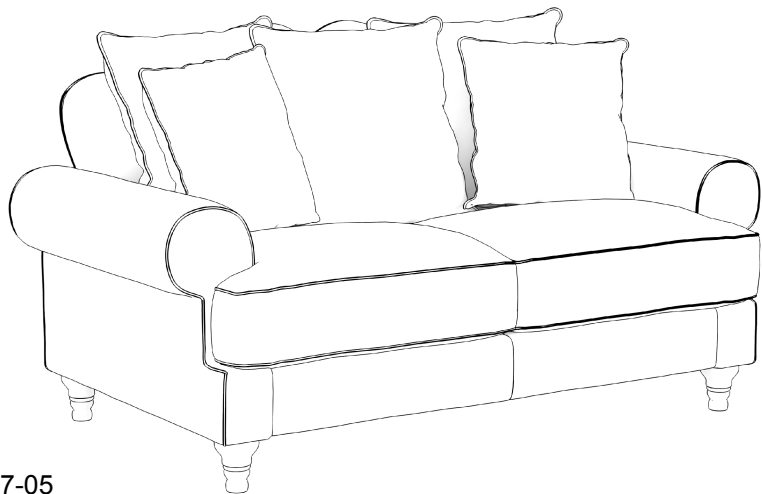

2023-07-05



15 min.

- | | |
|----------------------------------|------------------------------|
| (D) Montageanleitung | (GB) Assembly Instructions |
| (FR) Notice de montage | (IT) Istruzioni di montaggio |
| (NL) Handleiding voor de montage | (PL) Instrukcja montażu |
| (CZ) Montážní návod | (SK) Návod na montáž |
| (HU) Szerelési útmutató | (RO) Instrucțiuni de montaj |
| (TR) Montaj talimatı | (RU) Инструкции по монтажу |

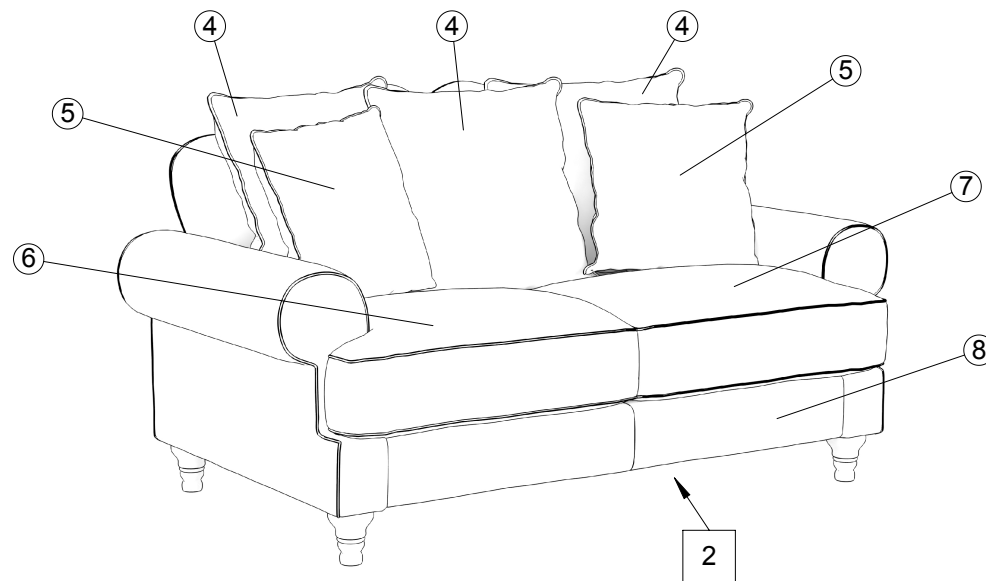
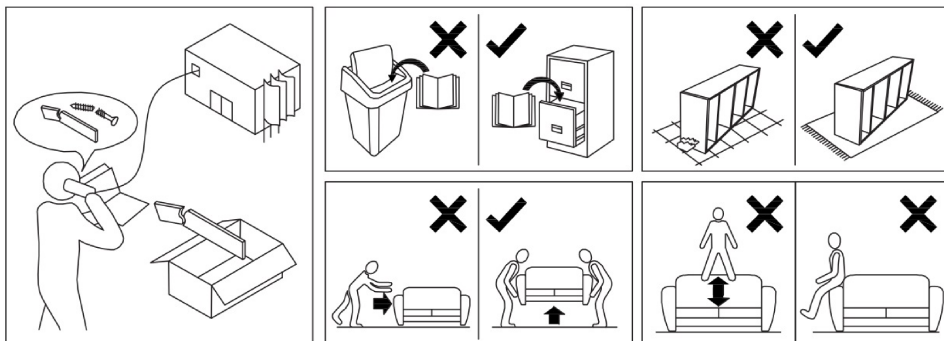

GT2
h = 120mm

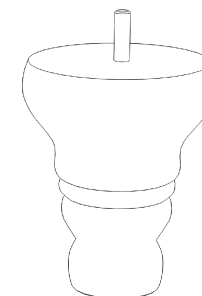

x4

1

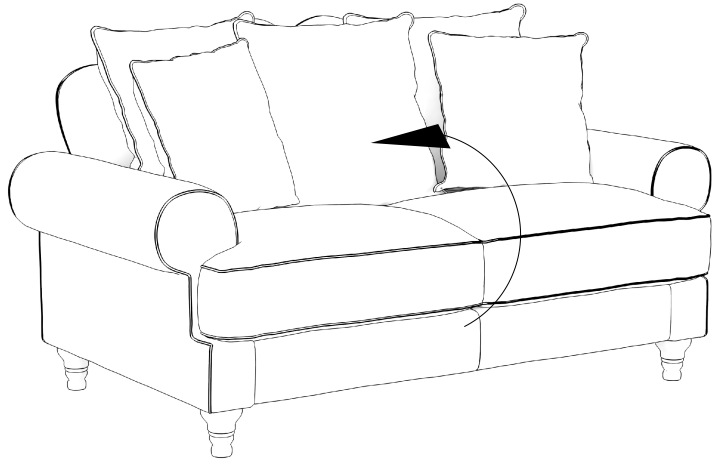

2

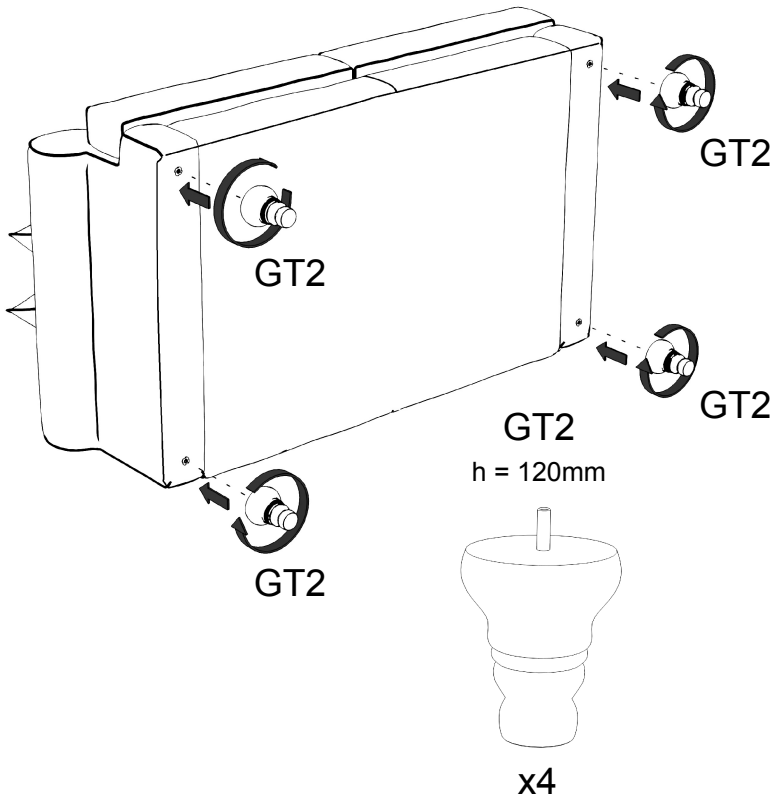

3

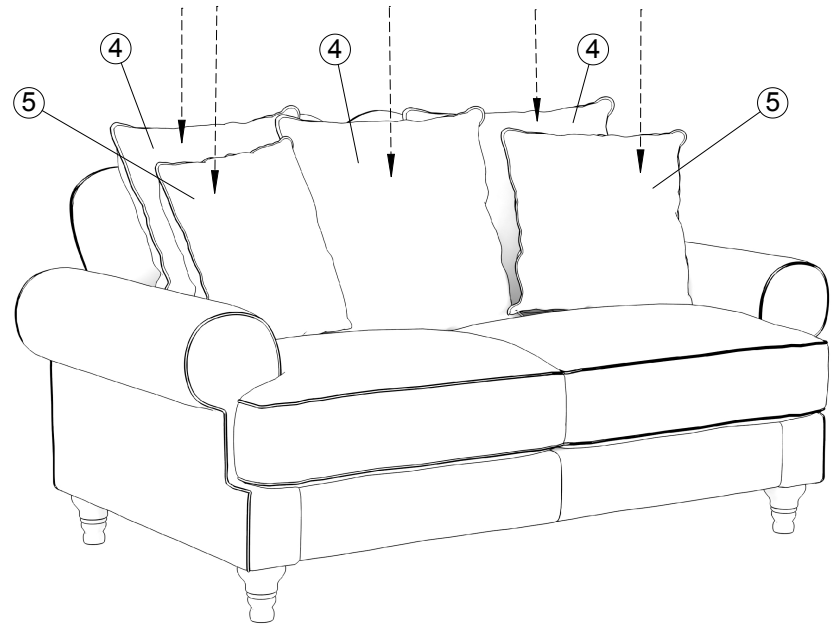
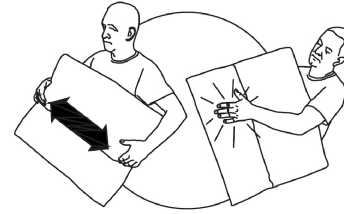

LISTA SKŁADOWA / COMPONENT LIST / KOMPONENTENLISTE

Nr / No	Nazwa / Name	Ilość / Quantity / Menge
4	Poduszka 57x57 / Pillow 57x57 / Kissen 57x57	3
5	Poduszka 42x42 / Pillow 42x42 / Kissen 42x42	2
6	Poduszka siedziskowa / Seat cushion / Sitzkissen	1
7	Poduszka siedziskowa / Seat cushion / Sitzkissen	1
8	Korpus mebla / Furniture body / Möbelkorpus	1
9	Noga meblowa / Furniture leg / Möbelbein	4

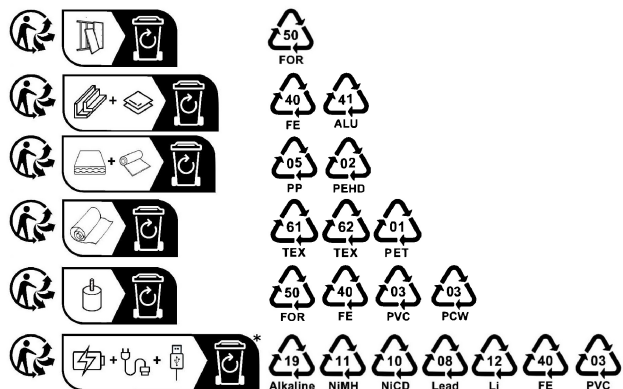

*optional / facultatif / opzionale / optioneel

KARTA SERWISOWA / SERVICE FORM / SERVICEKARTE

