

Malaga

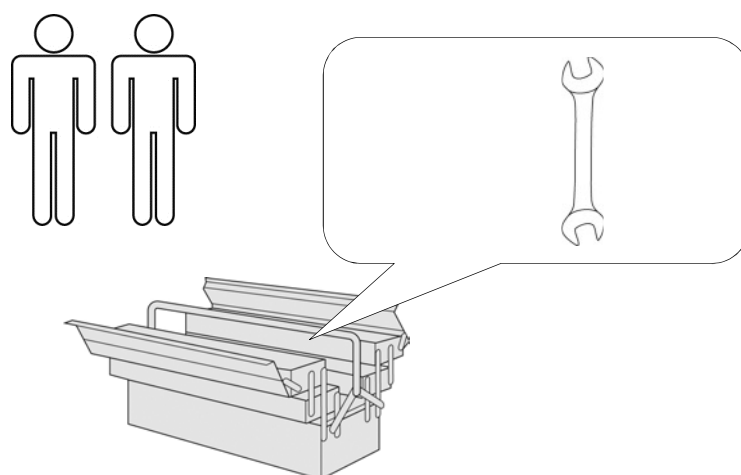





- | | |
|----------------------------------|---------------------------------------|
| D Montageanleitung | GB Assembly instructions |
| FR Notice de montage | NL Handleiding voor de montage |
| CZ Montážní návod | IT Istruzioni di montaggio |
| RO Instrucțiuni de montaj | RU инструкция по сборке |
| PL Instrukcja montażu | SK Návod na montáž |
| HU Szerelési útmutató | TR Montaj talimati |



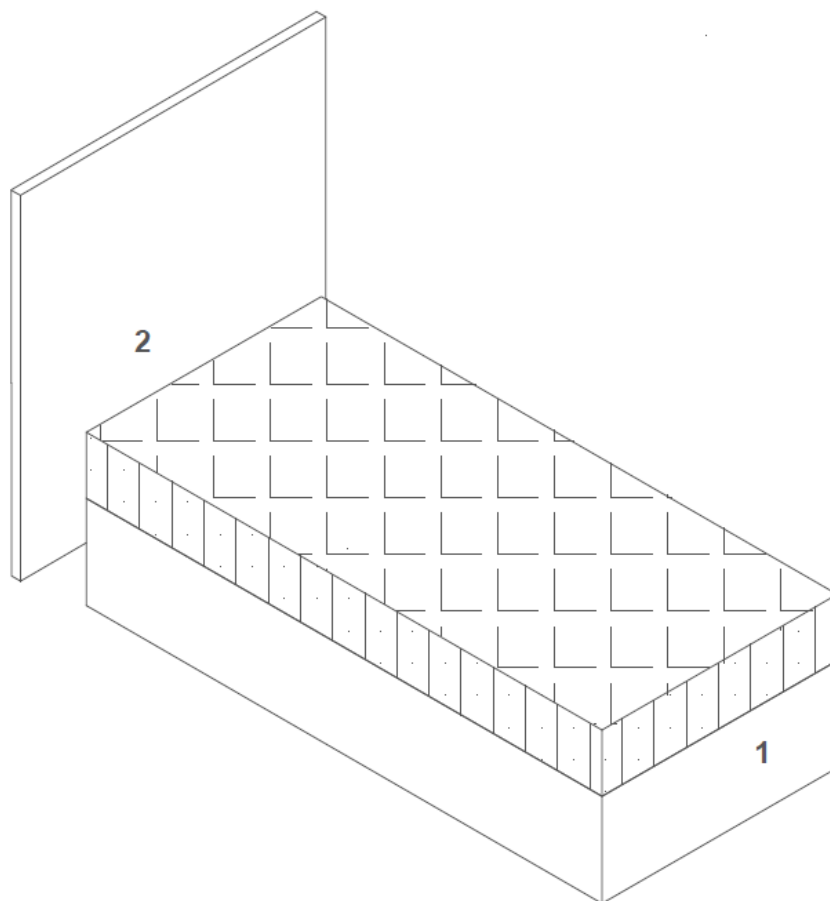

0
10
20
30
40
50
60
70
80
90
100
110
120
130
140
150
160
170
180
190
200

| Service • Assistenza • Dienstverlening • Serwis Servis • Szerviz • Сервисная служба | | |
|--|------------------|--|
| Name • Nom • Nome • Naam Nazwa • Jméno • Názov • Név Denumire • Ísim • Название | Malaga EB | |
| Nr. • No. • N° • Номер • Č • Sz | SH59 | |
| Typ • Type • Tip • Típus • Tipo Тип | BS | |
| | | |



| A | B | C |
|---|---|---|
|  |  |  |
| 4x 8x60 | 4x 8x40 | 4x M8 |



| | | | | |
|---|---|---|---|---|
| <p>A</p>  <p>4x 8x60</p> | <p>B</p>  <p>4x 8x40</p> | <p>C</p>  <p>4x M8</p> | <p>Achtung! Schrauben nicht überdrehen FR Attention! Ne serrez pas trop CZ Dávej Pozor! Nepřetahujte RO Ai Grija! Nu strângeți PL Uwaga! Nie dokręcać zbyt mocno HU Vigyázz! Ne húzza túl</p> | <p>GB Watch Out! Do not over tighten NL Let Op! Niet te vast IT Attenzione! Non stringere RU Осторожно! Не затягивайте SK Dávaj Pozor! Nepreťahujte TR Dikkat! Üzerinde sıkmayın</p> |
|---|---|---|---|---|

