

A 70PCS 	B 70PCS
C 70PCS $\phi 3.5 \times 14$ 	D 70PCS $\phi 3.5 \times 30$
E 20PCS $\phi 3.5 \times 40$ 	F 16PCS
G 12PCS 	H 2SET
G 2PCS 	H 6PCS
G 1SET 	

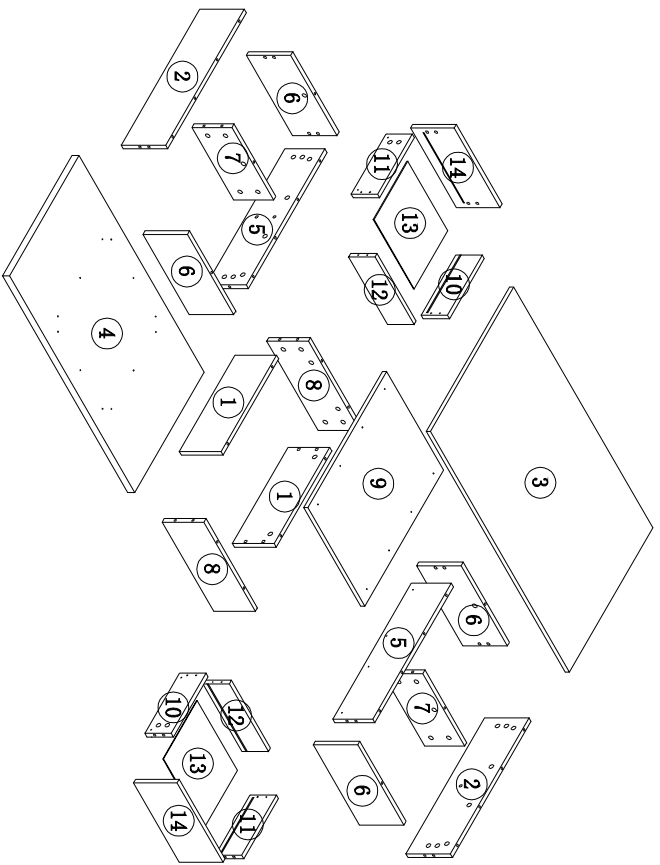

1

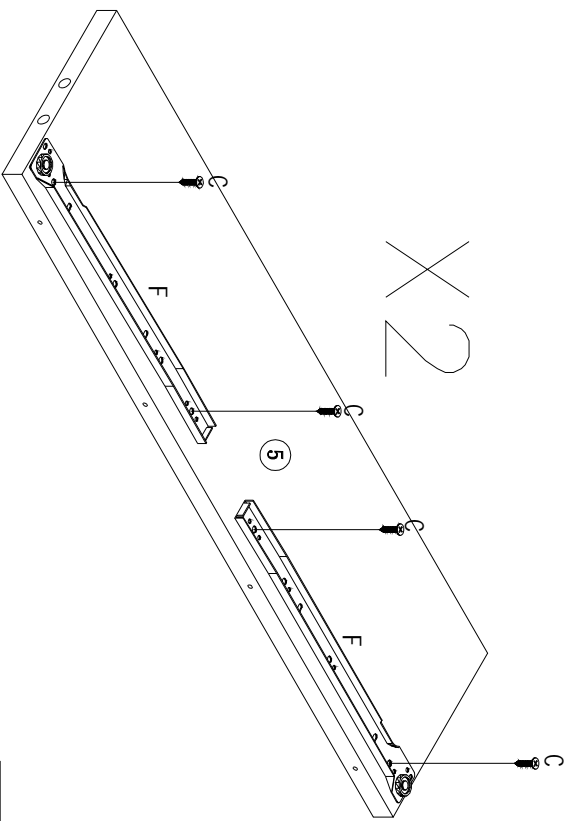

C	8PCS
F	4PCS

2

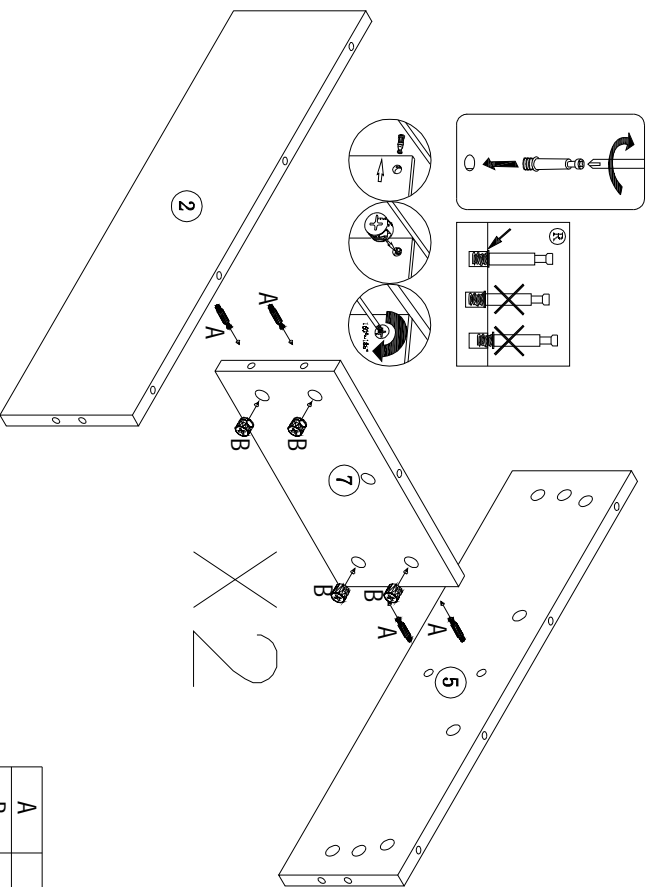

A	8PCS
B	8PCS

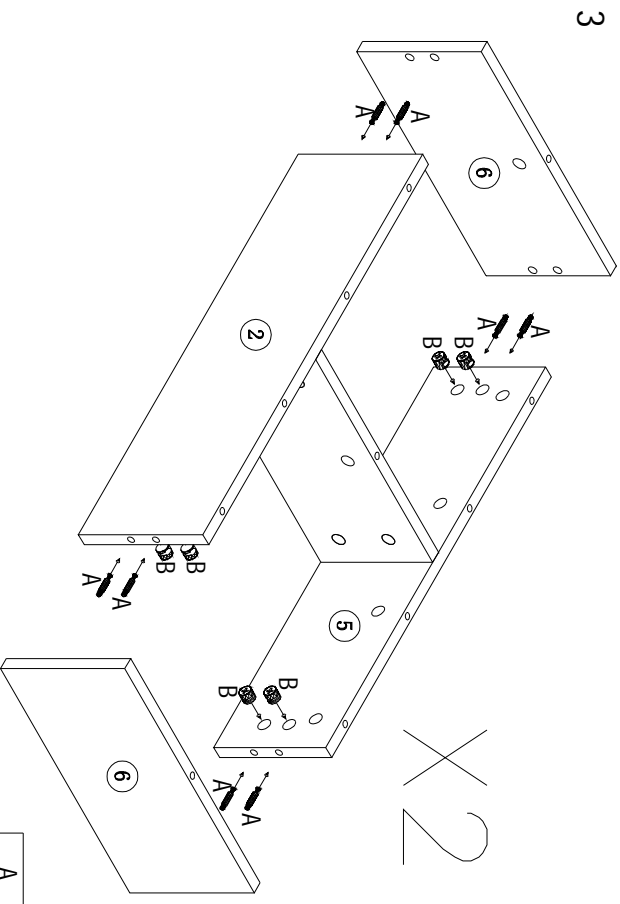

A	16PCS
B	16PCS

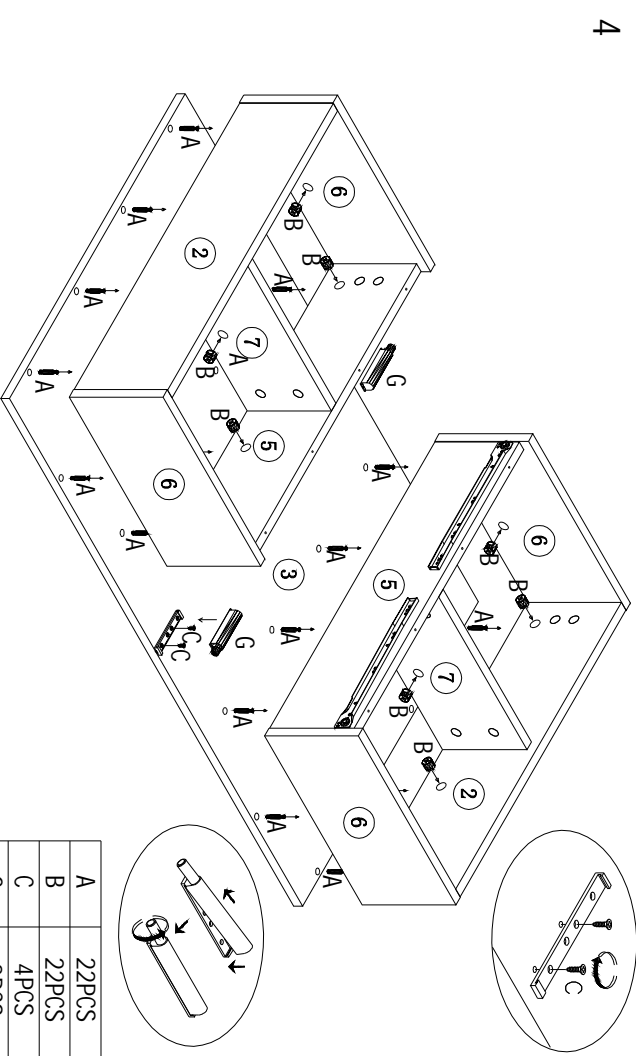

A	22PCS
B	22PCS
C	4PCS
G	2PCS

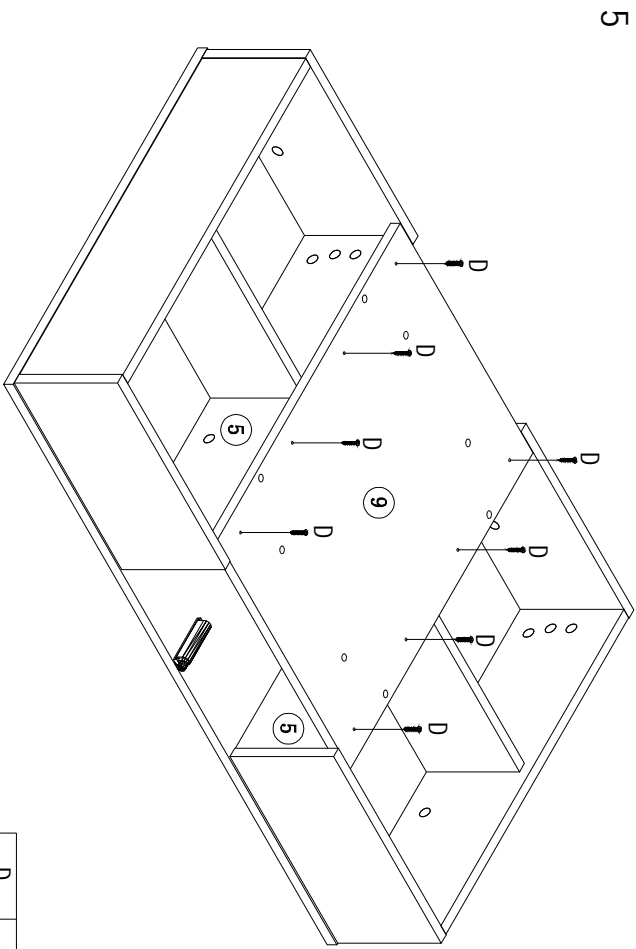

D	8PCS
---	------

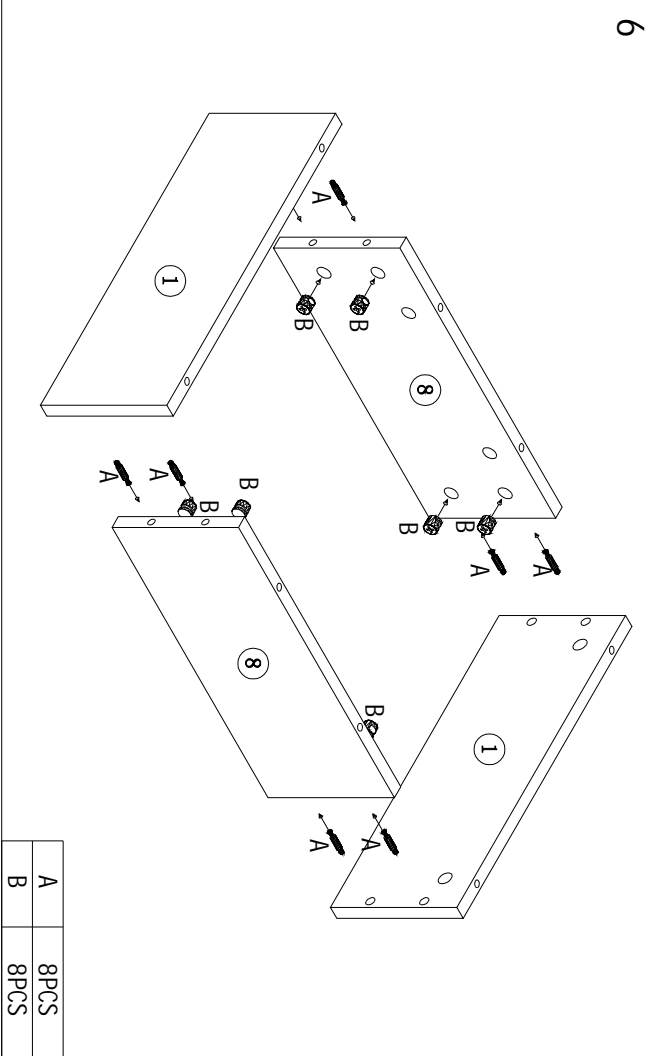

A	8PCS
B	8PCS

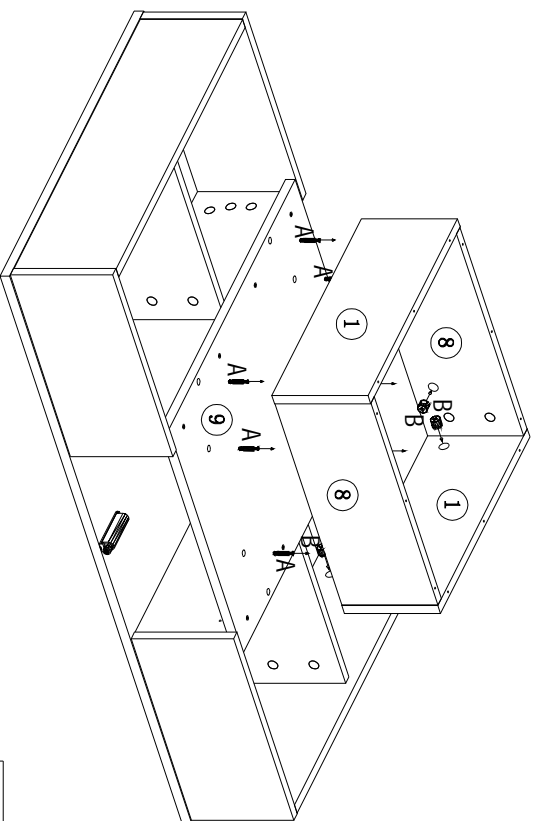

A	8PCS
B	8PCS

7

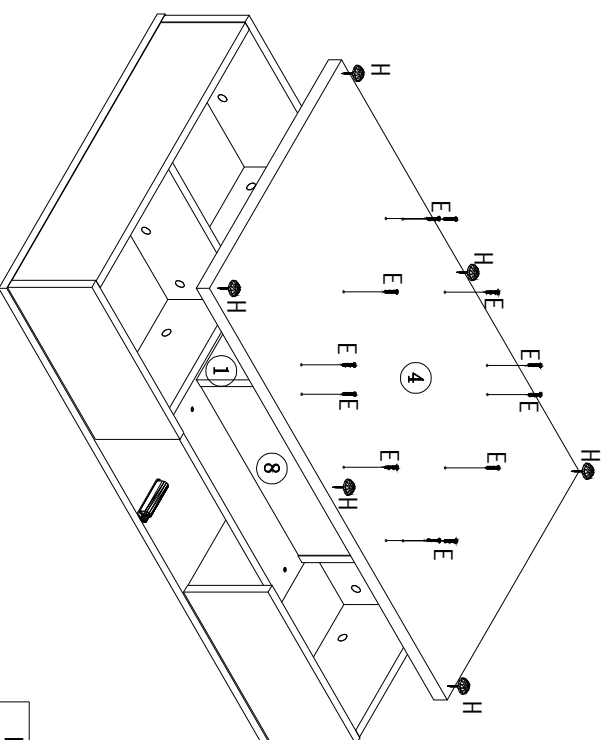

E	12PCS
H	6PCS

8

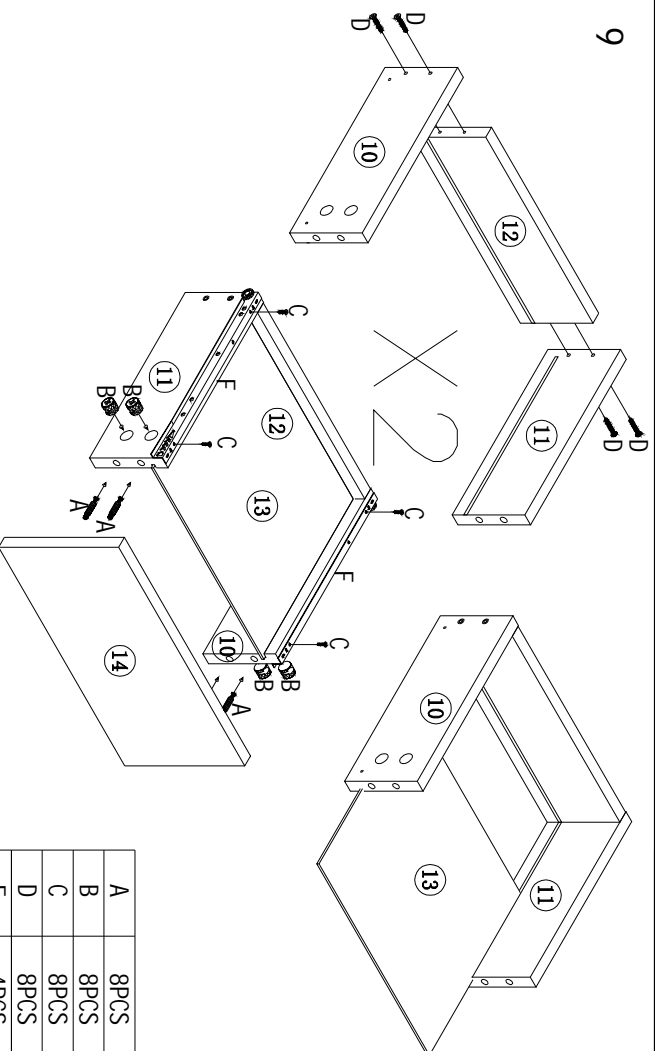

A	8PCS
B	8PCS
C	8PCS
D	8PCS
F	4PCS

9

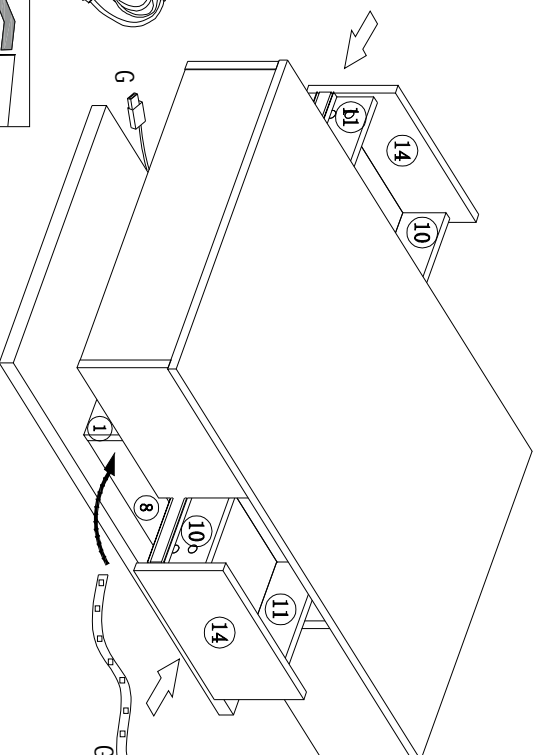

G	1SET
---	------

10