

(D) Montageanleitung

(GB) Assembly instructions

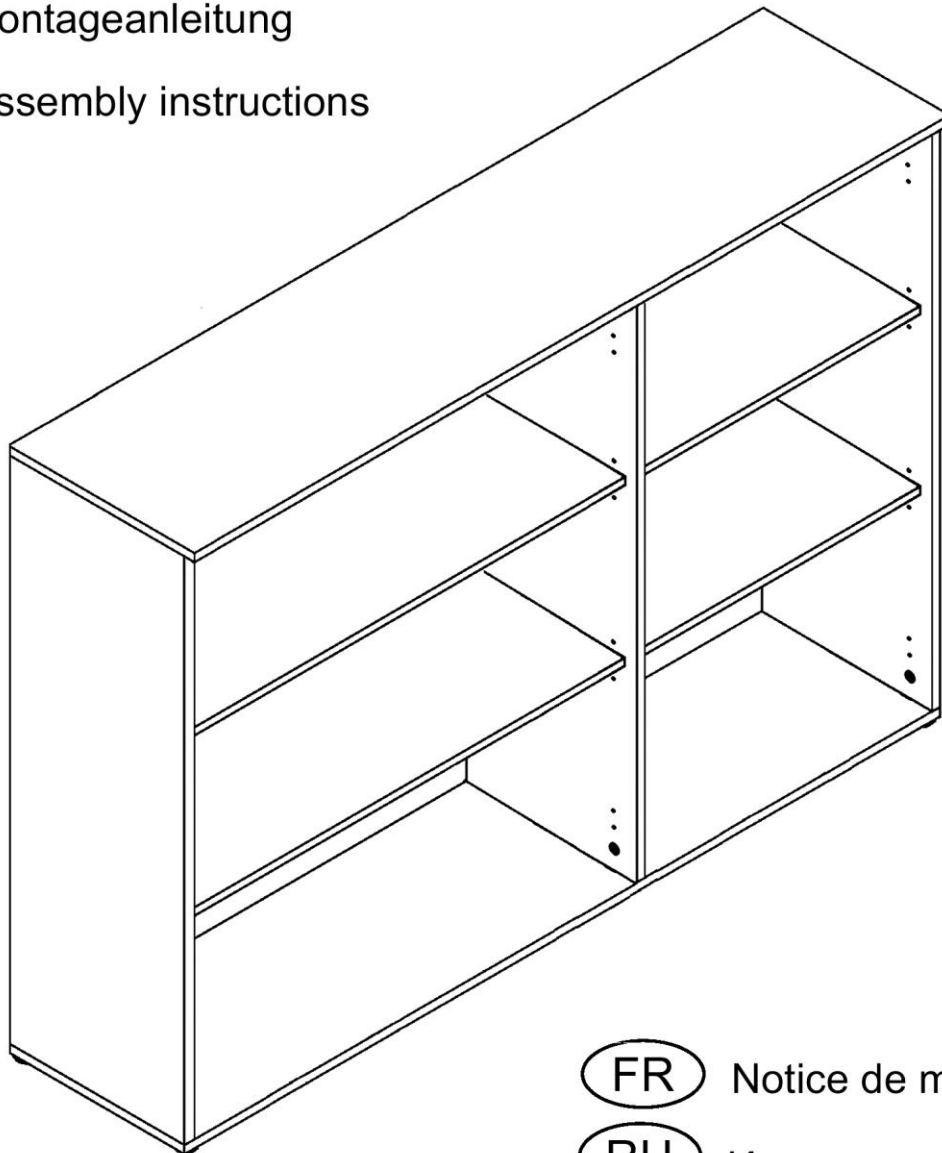

(FR) Notice de montage

(RU) Инструкция по монтажу

(TR) Montaj talimati

(IT) Istruzioni di montaggio

(SK) Návod na montáž

(CZ) Montážní návod

(HU) Szerelési útmutató

(NL) Handleiding voor de montage

(PL) Instrukcja montażu

(RO) Instrucțiuni de montaj

Service • Assistenza • Dienstverlening • Serwis
 Servis • Szerviz • Сервисная служба

Name • Nom • Nome • Naam •
 Nazwa • Jméno • Názov • Név •
 Denumire • Isim • Название

Nr. • No. • N° • Номер • Č. • Sz

Тур • Type • Tip • Típus • Тиро •
 Тип

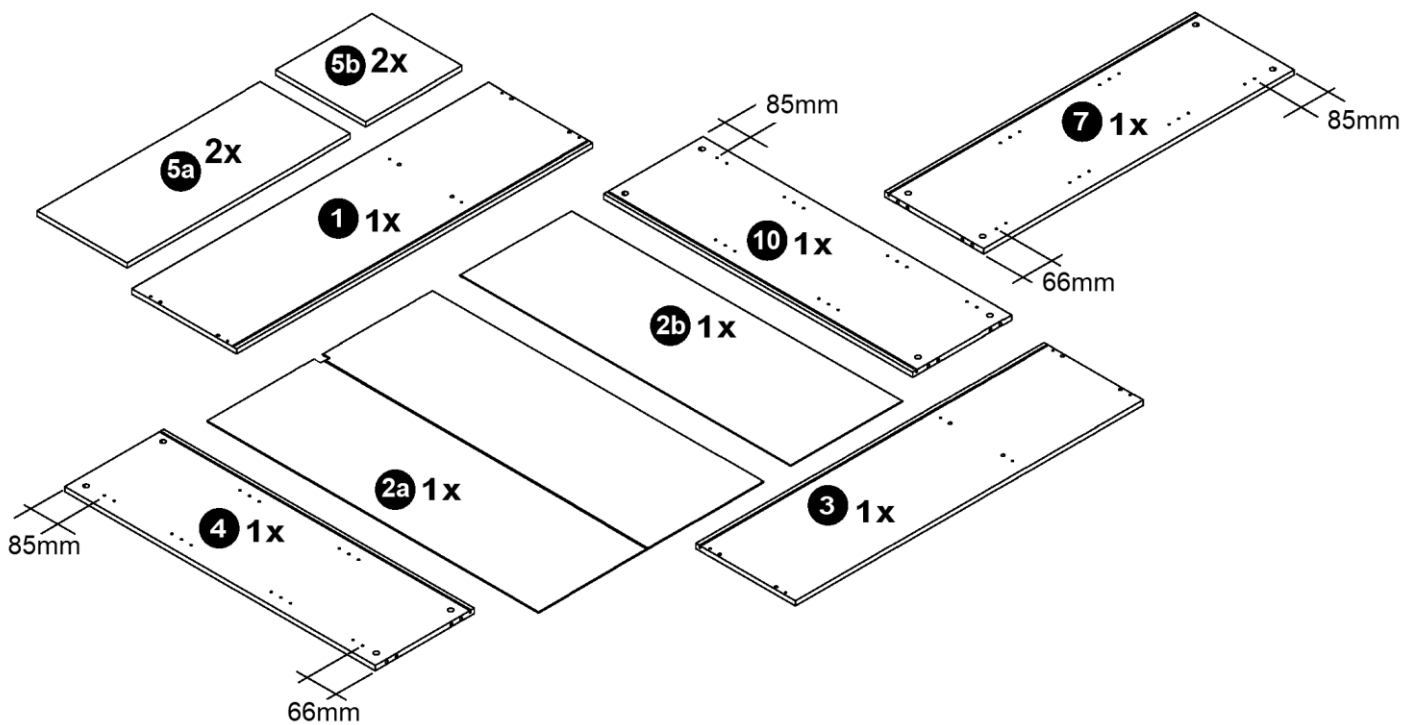
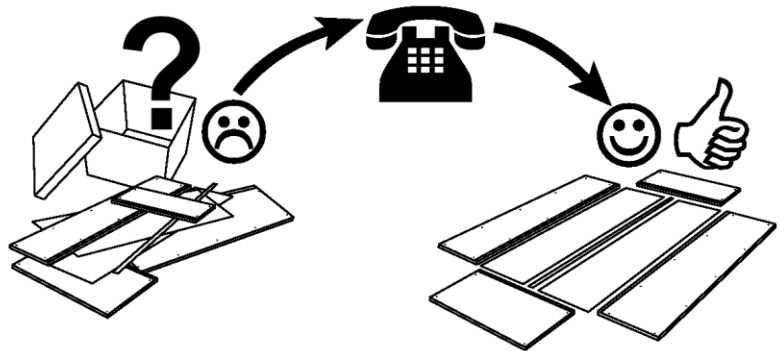
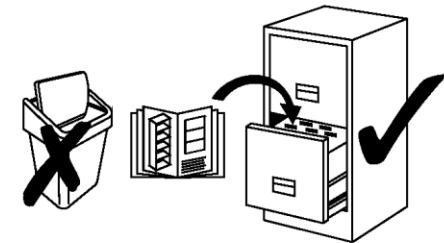

1	1x	ca. 1140 x 350 mm	4	1x	ca. 1112 x 330 mm	5b	2x	ca. 356 x 300 mm	10	1x	ca. 1112 x 330 mm
2a	1x	ca. 1124 x 747 mm	5a	2x	ca. 738 x 300 mm	7	1x	ca. 1112 x 330 mm			
2b	1x	ca. 1124 x 365 mm									
3	1x	ca. 1140 x 330 mm									

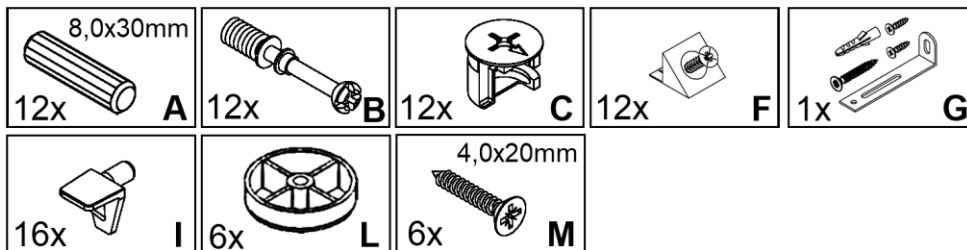

1

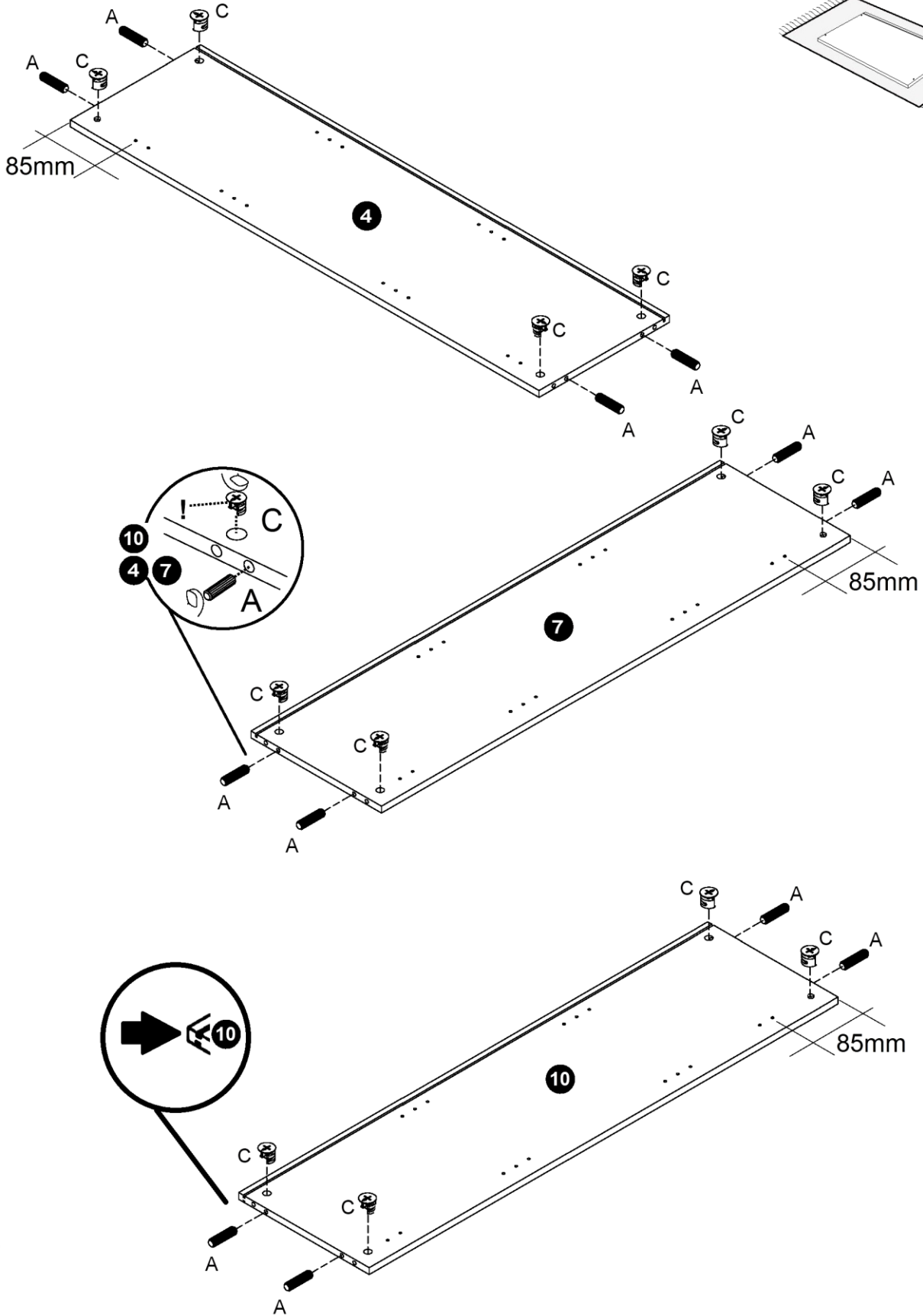
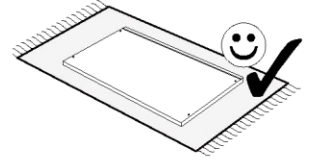
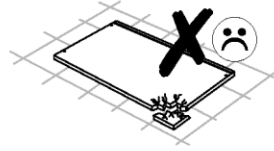

2

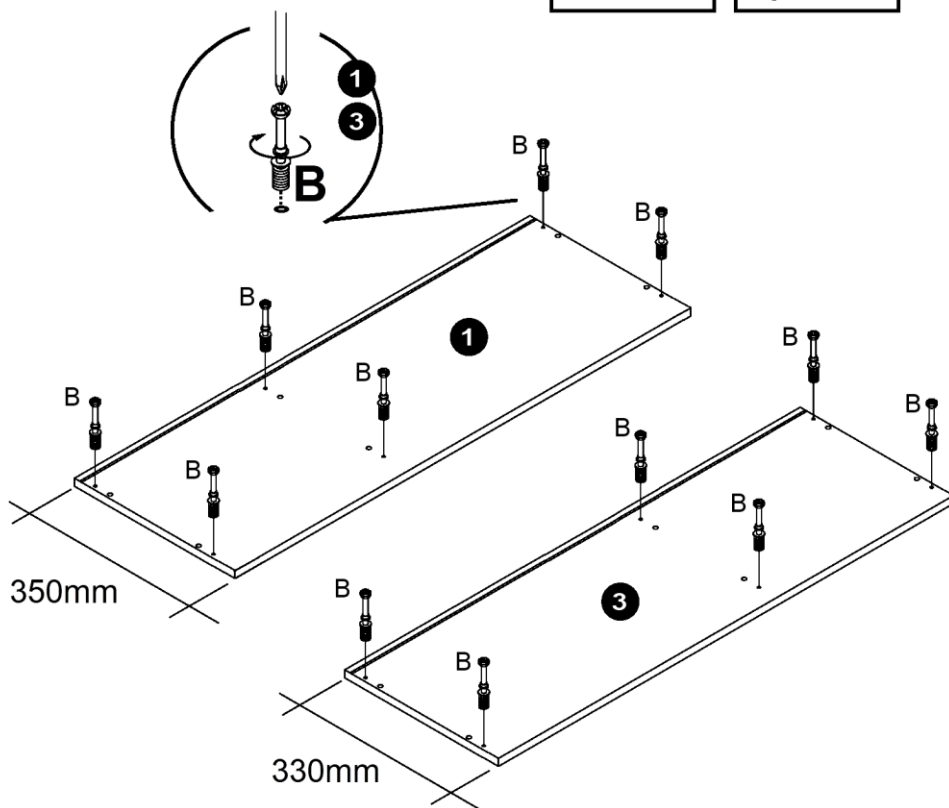
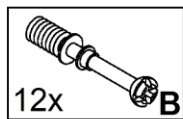
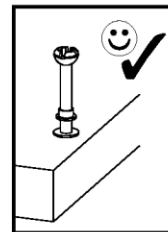
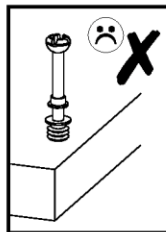
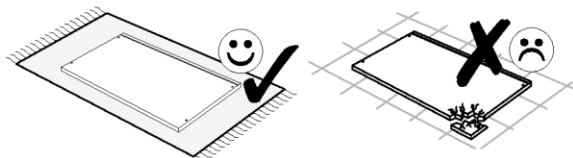

3

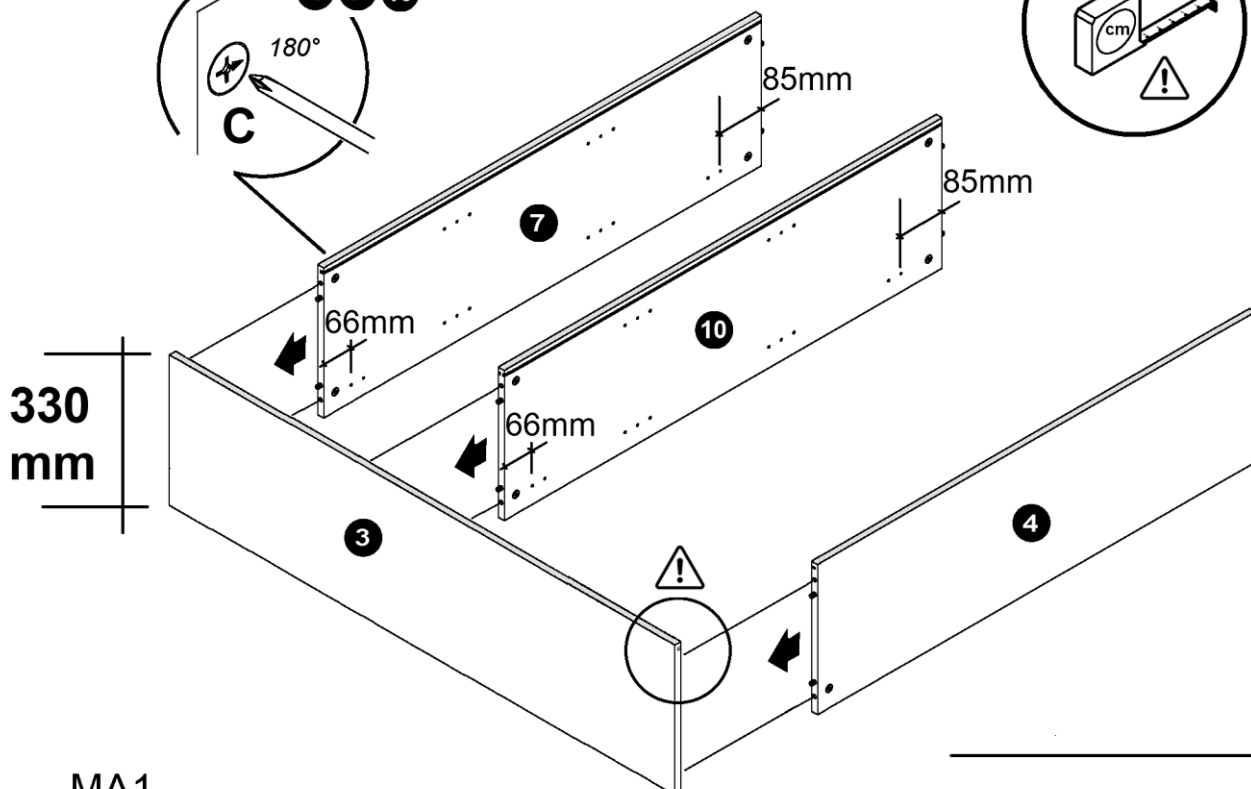
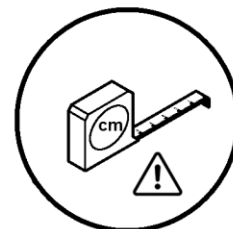
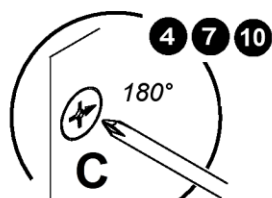

4

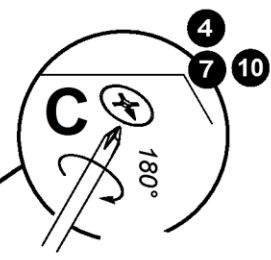
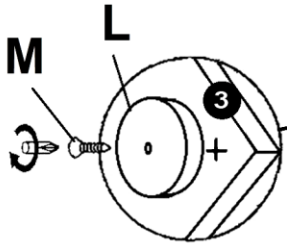
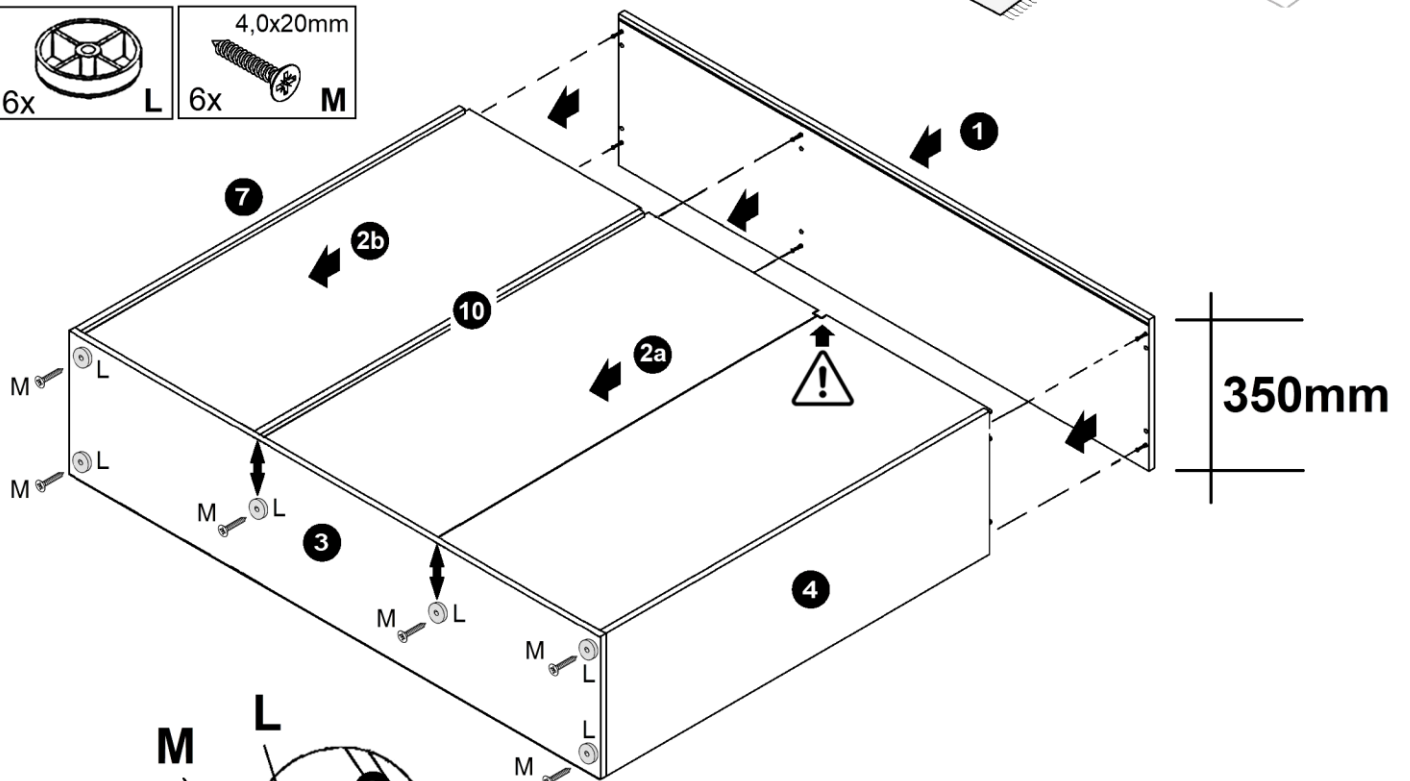
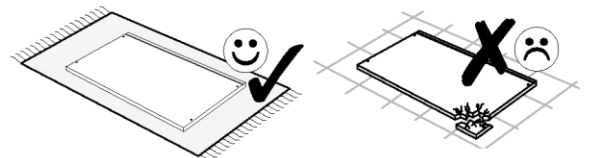
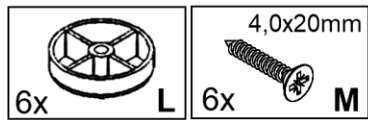

5

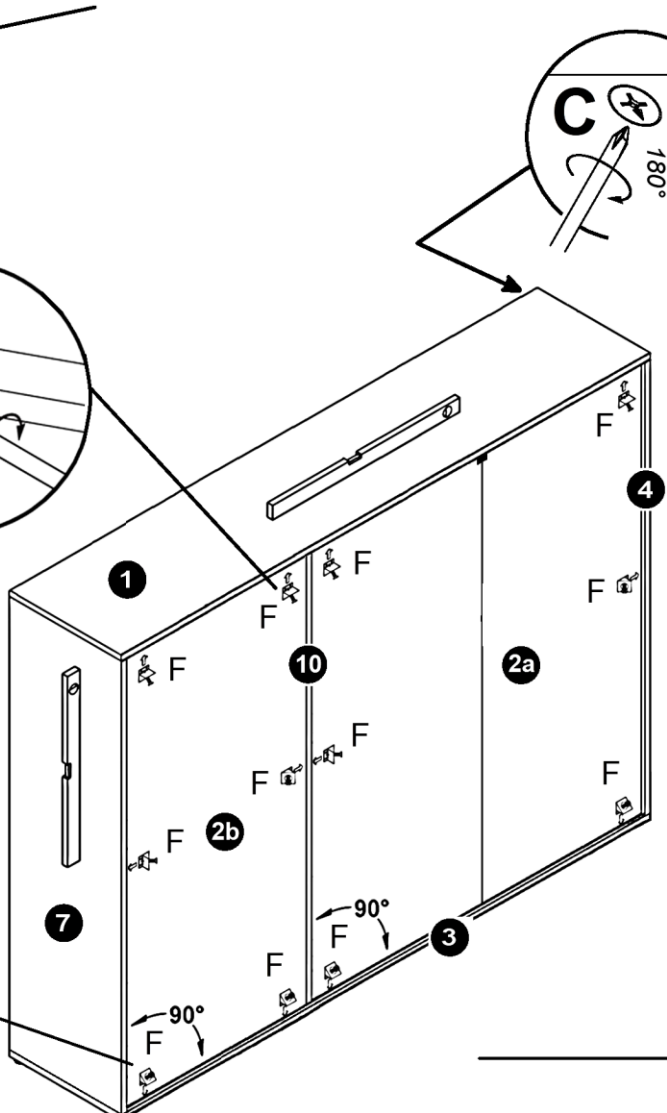
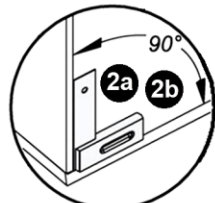
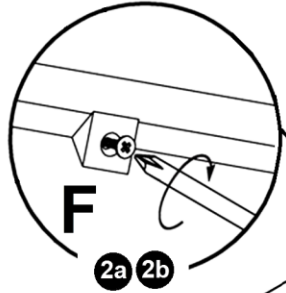
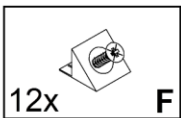

6

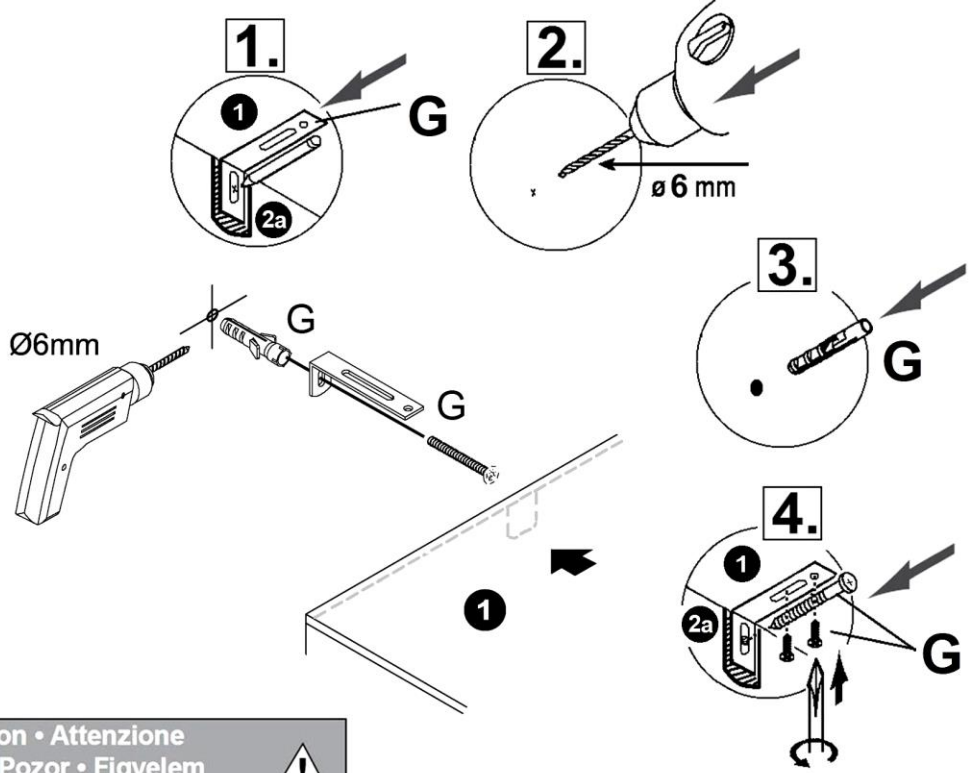
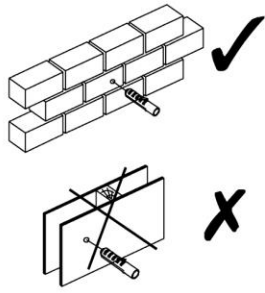
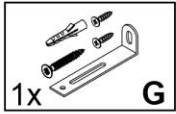

⚠ Achtung • Attention • Attenzione Opgelet • Uwaga • Pozor • Figyelem Atenție • Dikkat • Внимание ⚠	
(D)	Wandbefestigung dient als Kippschutz – unbedingt anbringen! Bei einigen Wandtypen kann ein Spezialdübel erforderlich sein!
(GB)	The wall fastening serves to prevent tipping – be absolutely sure to mount it! For certain wall types, a special wall plug may be necessary!
(FR)	La fixation murale sert de protection contre le basculement – à installer impérativement ! Pour certains types de murs il faut des chevilles spéciales !
(IT)	Il fissaggio alla parete serve da protezione anti-ribaltamento – attaccarla assolutamente! Per alcune strutture di parete può essere necessario un tassello speciale!
(NL)	Bevestiging aan de muur dient als kantelbescherming – zeker en vast bevestigen! Bij enkele muurtypes is een speciale plug misschien vereist!
(PL)	Mocowanie do ściany jest jednocześnie zabezpieczeniem przed przewróceniem – koniecznie zamontować! Do niektórych rodzajów ścian koniecznie zastosować specjalne kołki mocujące.

(CZ)	Montáž na stěnu slouží jako ochrana proti převrnutí – bezpodmínečně umístěte! U některých typů stěn může být zapotřebí speciální hmoždinka!
(SK)	Upevnenie na stenu slúži ako ochrana proti prevráteniu – bezpodmienečne použite! Pre niektoré druhy stien môže byť potrebná špeciálna hmoždinka!
(HU)	A termék a falhoz kel rögzítési, különben az felborulhat! Egyes faltípusoknál speciális tiplit kell használni!
(RO)	Sistemul de fixare la perete servește ca protecție la răsturnare – de montat obligatoriu! Pentru unele tipuri de pereți este posibil să fie necesar un diblu special!
(TR)	Duvardaki sabitleme, devrilmeye karşı bir emniyet tedbiridir ve mutlaka monte edilmelidir! Bazı duvar tiplerinde bunun için özel bir dübel gerekli olabilir!
(RU)	Обязательно установите крепление на стене во избежание опрокидывания! Для некоторых типов стен может потребоваться специальный дюбель!

7

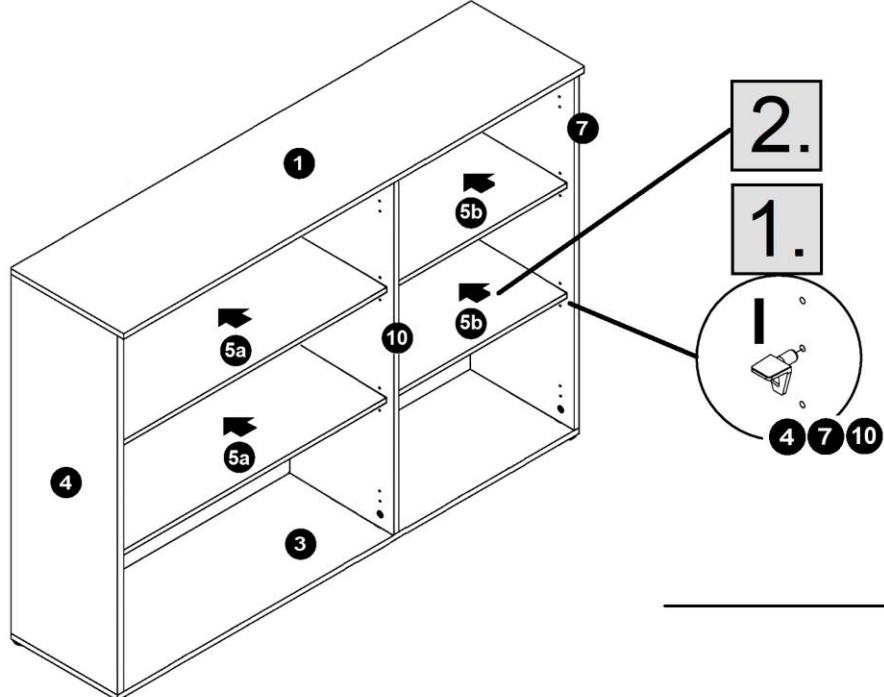
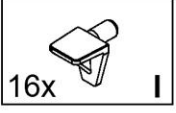

MA1