

SOLVEI  
8100/2503  
2501/8300

- |           |  |           |   |
|-----------|--|-----------|---|
| <b>D</b>  | MONTAGEANLEITUNG<br>BEDIENUNGSANLEITUNG                | <b>GB</b> | ASSEMBLY INSTRUCTIONS<br>INSTRUCTION MANUAL         |
| <b>NL</b> | HANDLEIDING VOOR DE MONTAGE<br>GEBRUIKSAANWIJZING      | <b>PL</b> | INSTRUKCJA MONTAŻU<br>INSTRUKCJA OBSŁUGI            |
| <b>TR</b> | MONTAJ TALIMATI<br>KULLANIM KLAVUZU                    | <b>RU</b> | ИНСТРУКЦИЯ ПО МОНТАЖУ<br>ИНСТРУКЦИЯ ПО ЭКСПЛУАТАЦИИ |
| <b>RO</b> | INSTRUCȚIUNI DE INSTALARE<br>INSTRUCȚIUNI DE UTILIZARE | <b>IT</b> | ISTRUZIONI DI MONTAGGIO<br>MANUALE DI ISTRUZIONI    |
| <b>FR</b> | NOTICE DE MONTAGE<br>MANUEL INSTRUCTIONS               | <b>SK</b> | MONTÁŽNY NÁVOD<br>NÁVOD NA POUŽITIE                 |
| <b>HU</b> | KÖZGYŰLÉS UTASÍTÁSOK<br>KEZELÉSI UTASÍTÁS              | <b>CZ</b> | MONTÁŽNÍ NÁVOD<br>NÁVOD K POUŽITÍ                   |
| <b>SI</b> | NAVODILA ZA MONTAŽO<br>NAVODILA ZA UPORABO             | <b>PT</b> | INSTRUÇÕES DE MONTAGEM<br>MANUAL DO USUÁRIO         |
| <b>ES</b> | INSTRUCCIONES DE MONTAJE<br>MANUAL DEL USUARIO         | <b>HR</b> | UPUTE ZA MONTAŽU<br>UPUTE ZA UPOTREBU               |

**F/B**

222401

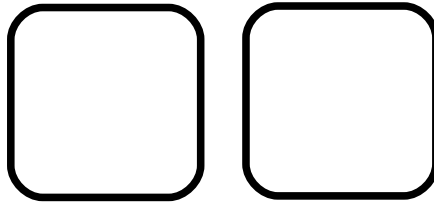

0064

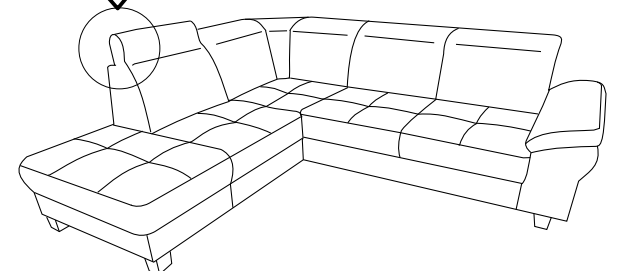
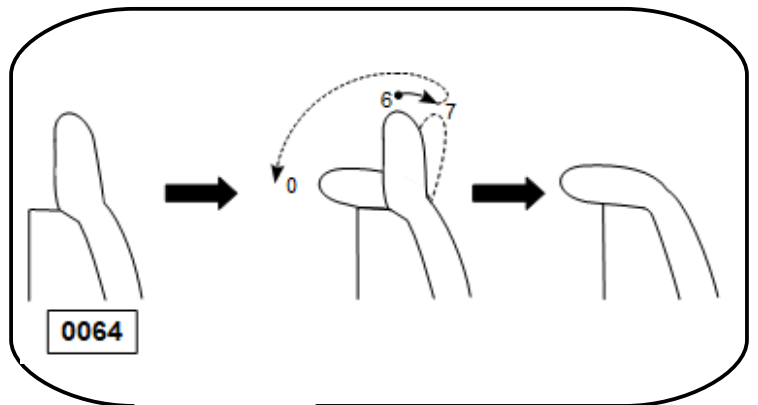
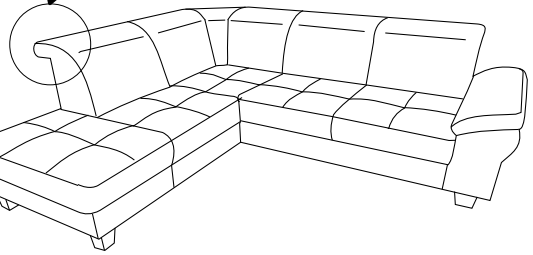
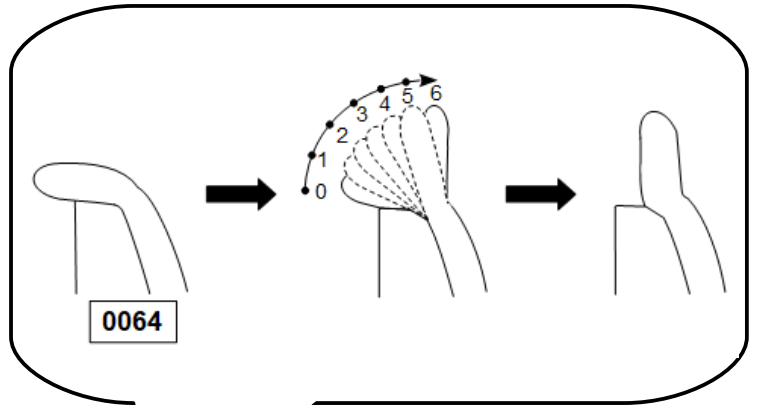
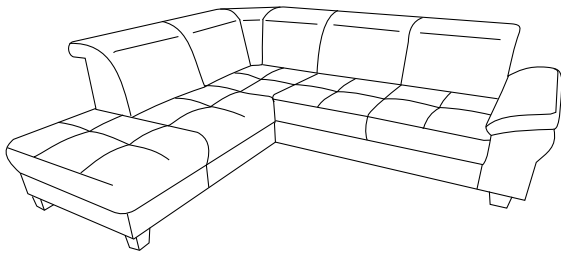

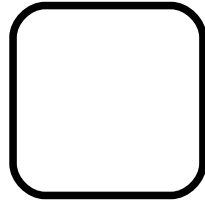
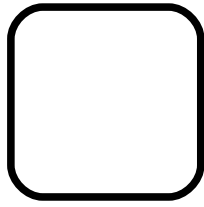

0019

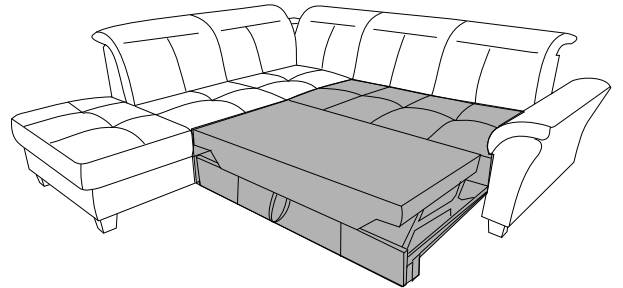
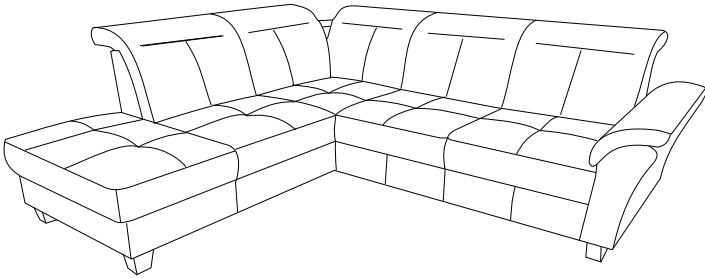

0019



0037

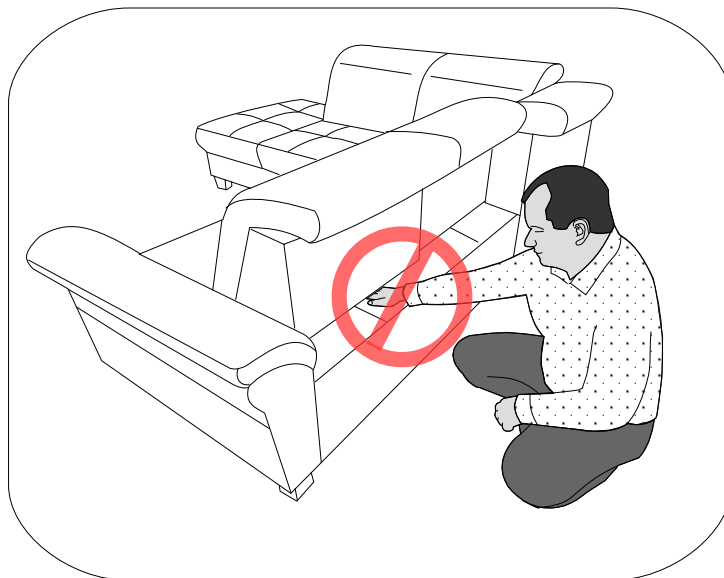



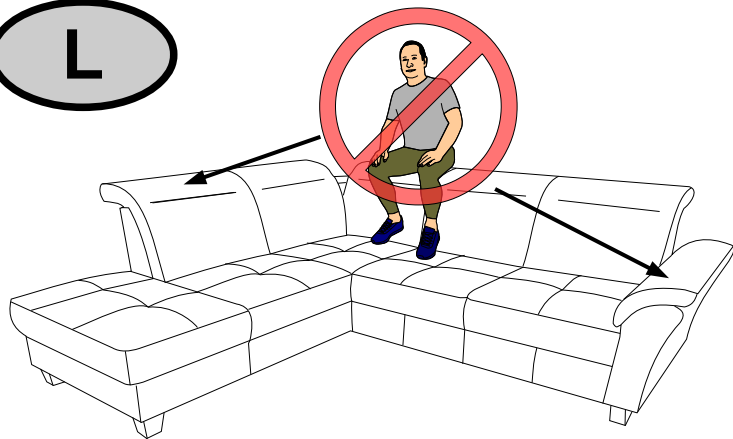

L

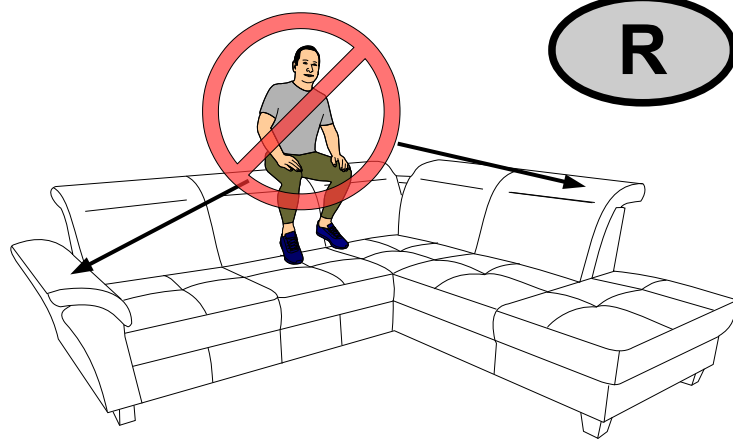





R

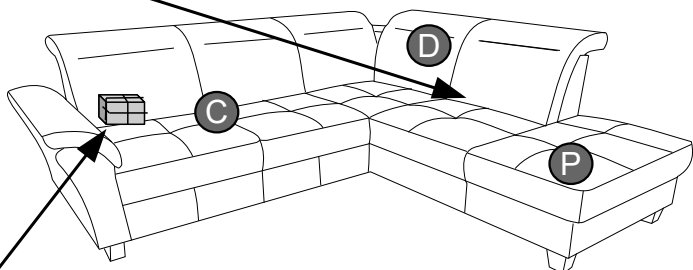
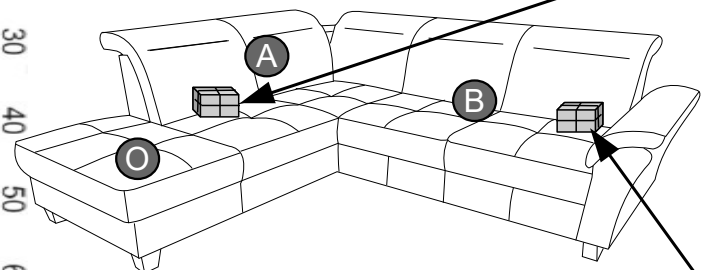

<b>i</b> L-5 	<b>s</b> H-90 	<b>q</b> M8*80 	<b>g</b> H-90 	<b>x</b> Fi-50 	[mm]
X1	X4	X4	X3	X4	





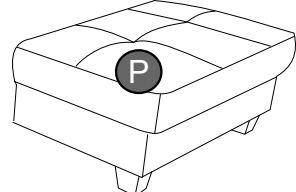
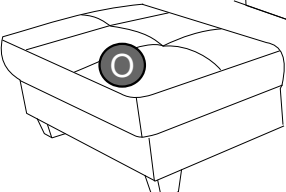
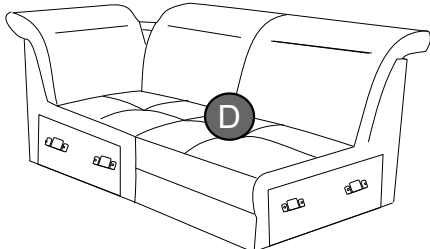
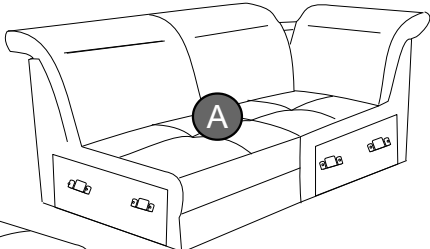
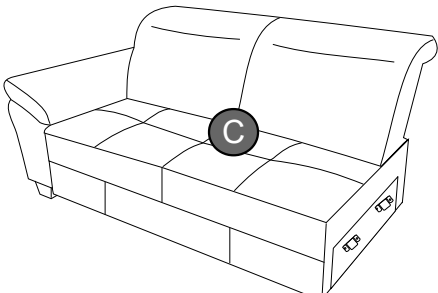
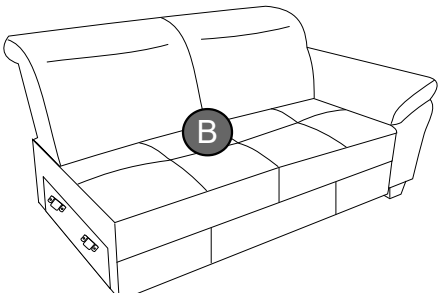

<b>i</b> L-5 	<b>s</b> H-90 	<b>q</b> M8*80 	<b>x</b> Fi-50 
X1	X2	X2	X2

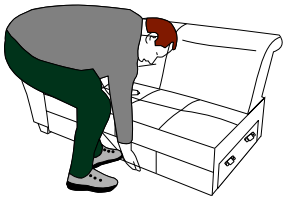

0  
10  
20  
30  
40  
50  
60  
70  
80  
90  
100  
110  
120  
130  
140  
150  
160  
170  
180  
190  
200







<b>i</b> L-5 	<b>s</b> H-90 	<b>q</b> M8*80 	<b>x</b> Fi-50 
X1	X2	X2	X2

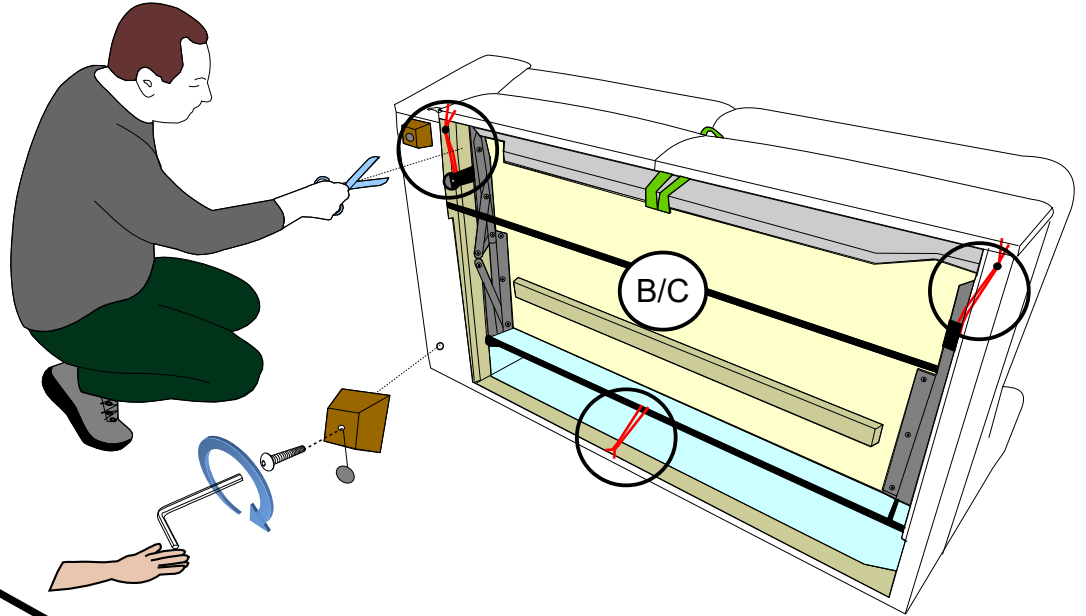







90°

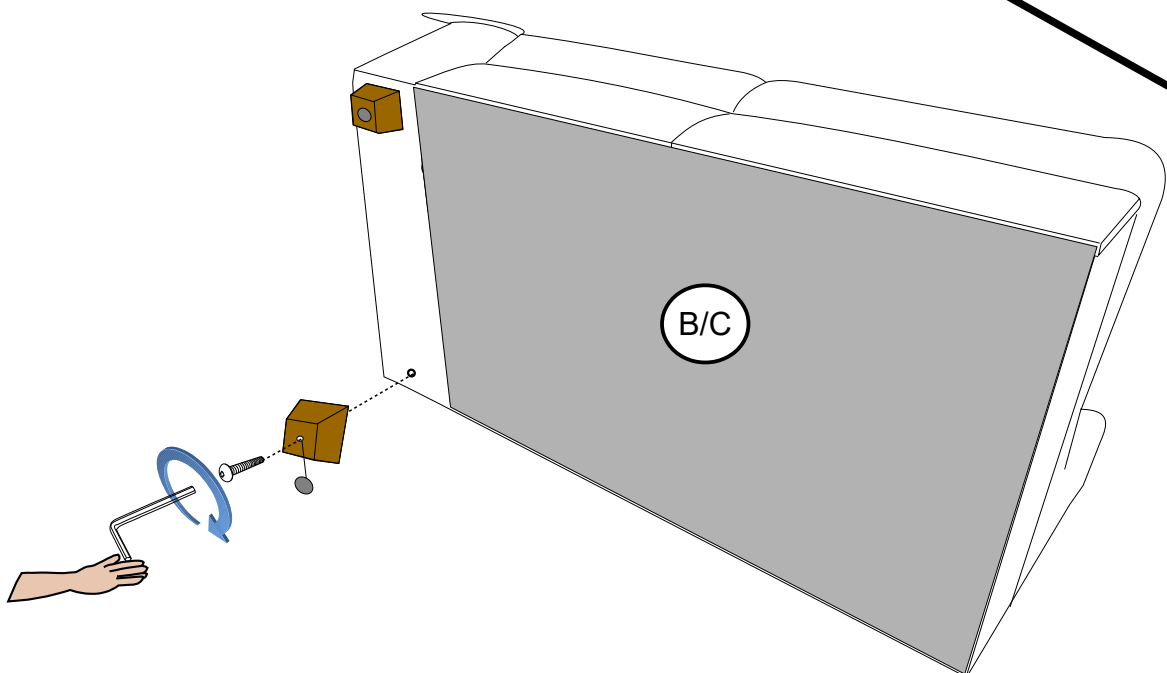





0019

<b>i</b> L-5 	<b>s</b> H-90 	<b>q</b> M8*80 	<b>x</b> Fi-50 
X1	X2	X2	X2

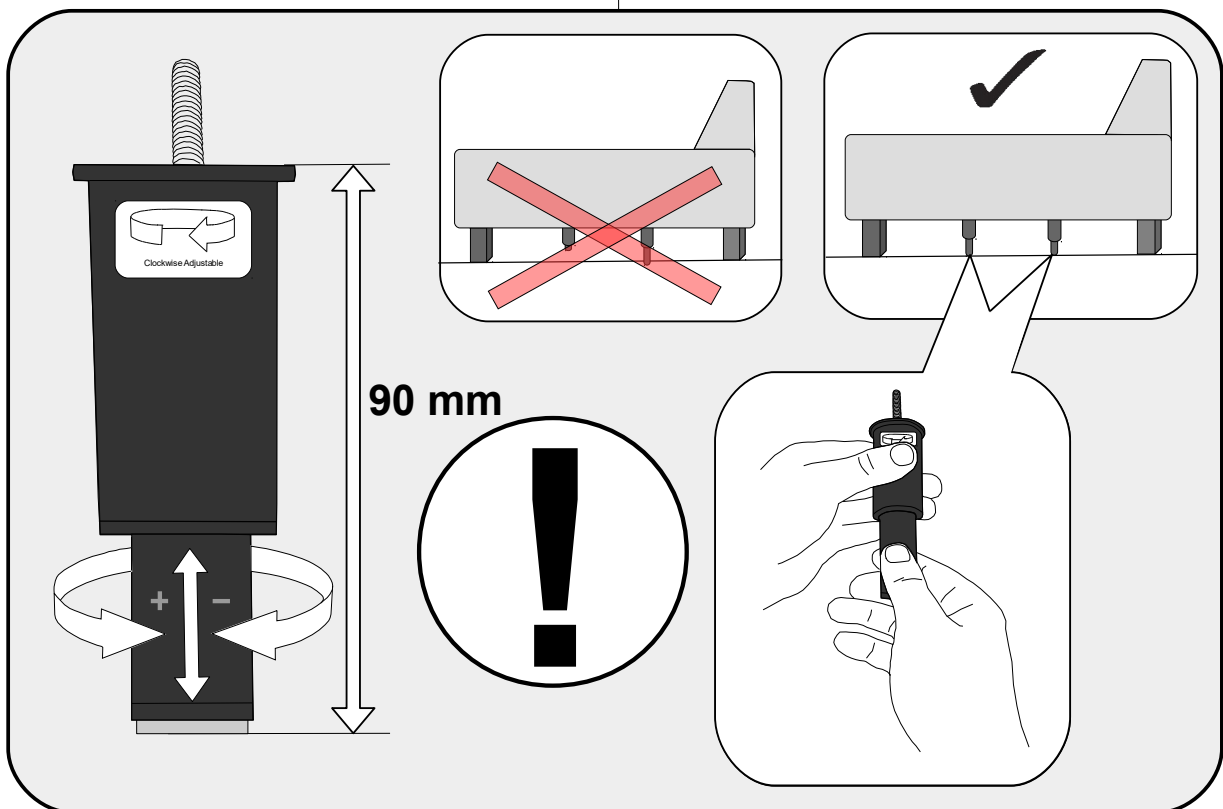
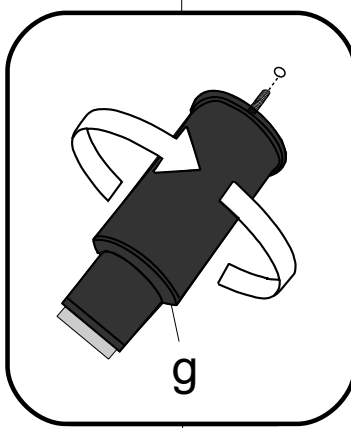
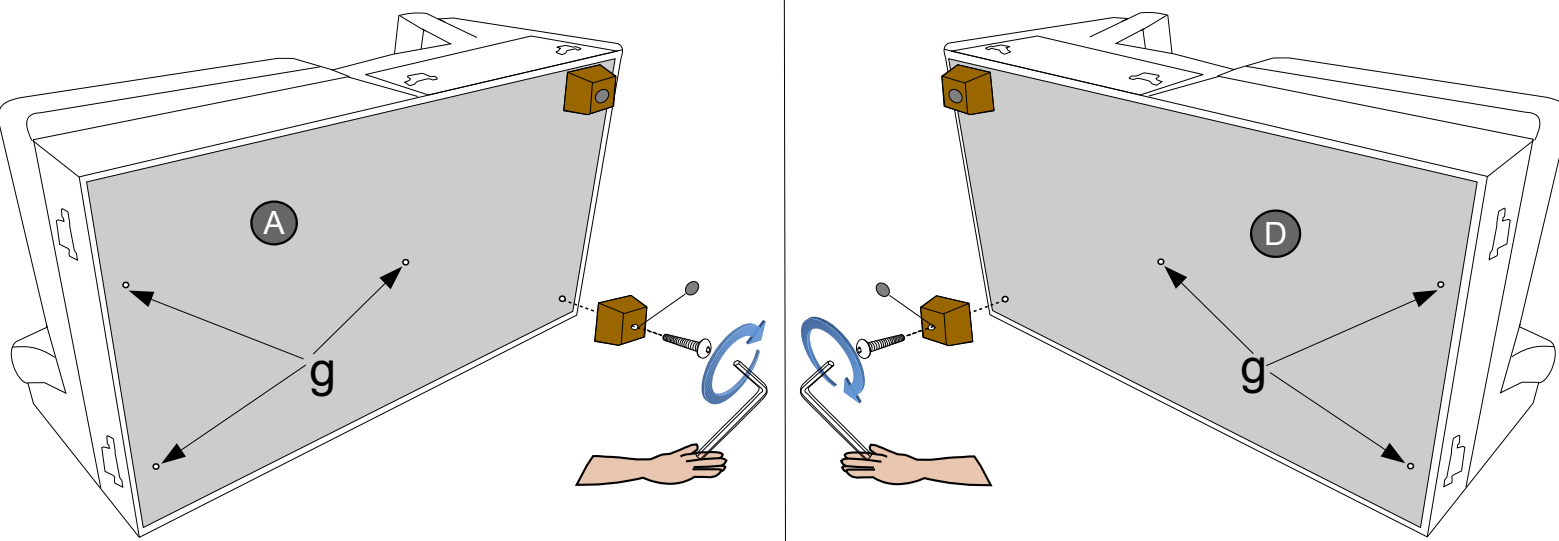

<b>i</b> L-5	<b>s</b> H-90	<b>q</b> M8*80	<b>g</b> H-90	<b>x</b> Fi-50
				
X1	X2	X2	X3	X2



<b>i</b> L-5	<b>s</b> H-90	<b>q</b> M8*80	<b>x</b> Fi-50
			
X1	X2	X2	X2

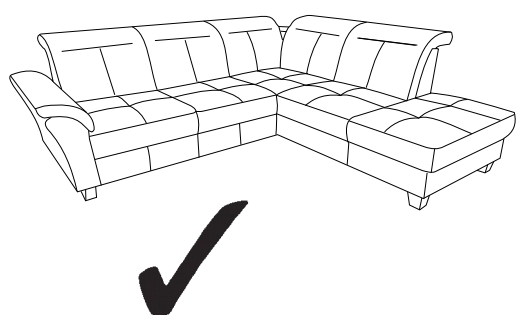
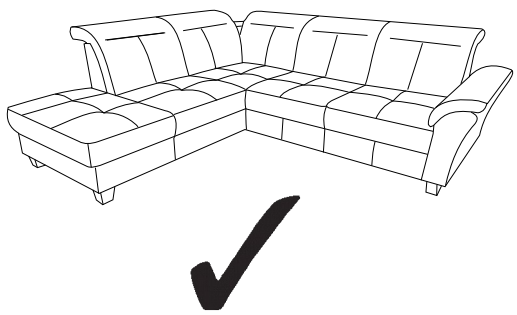
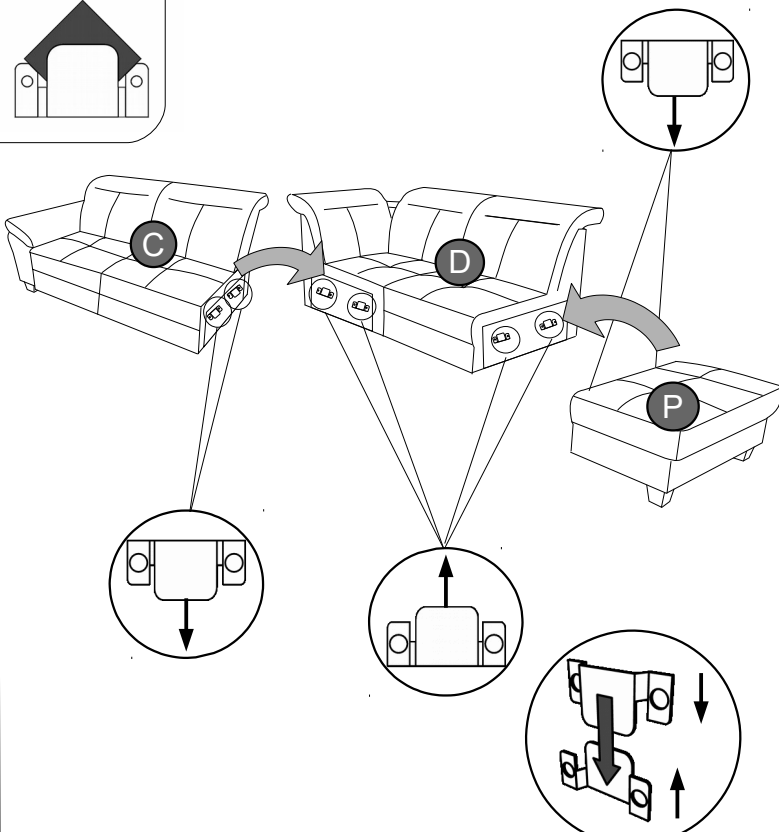
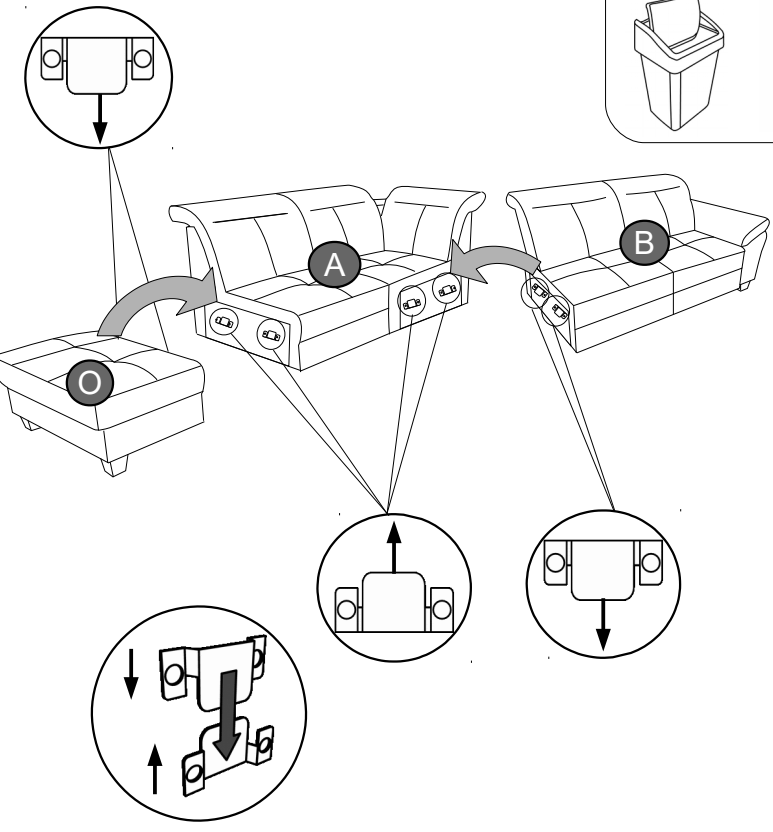
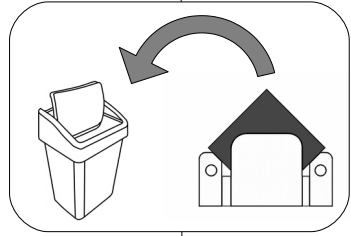
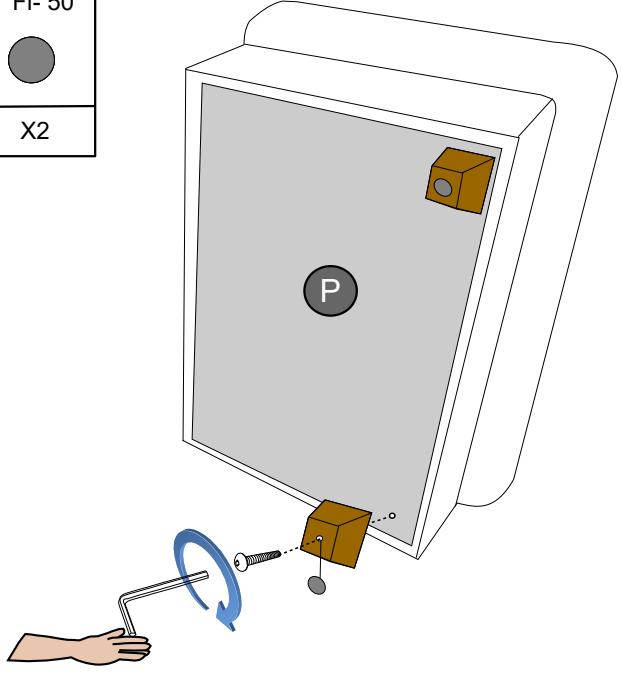
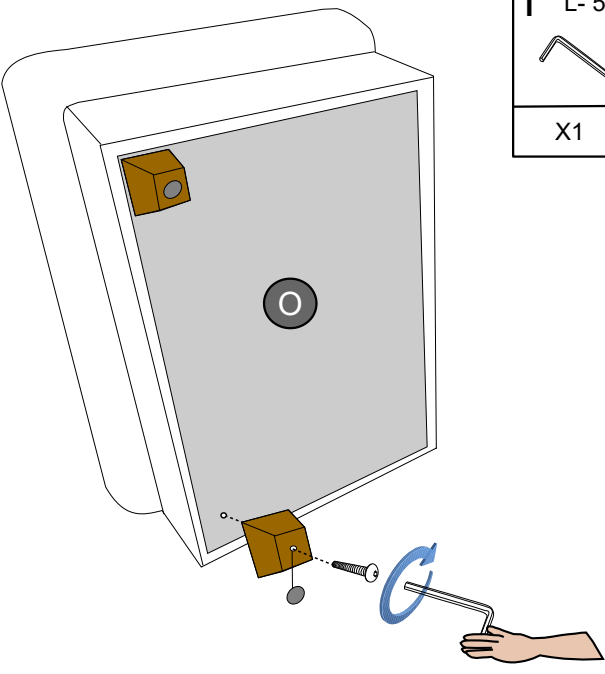

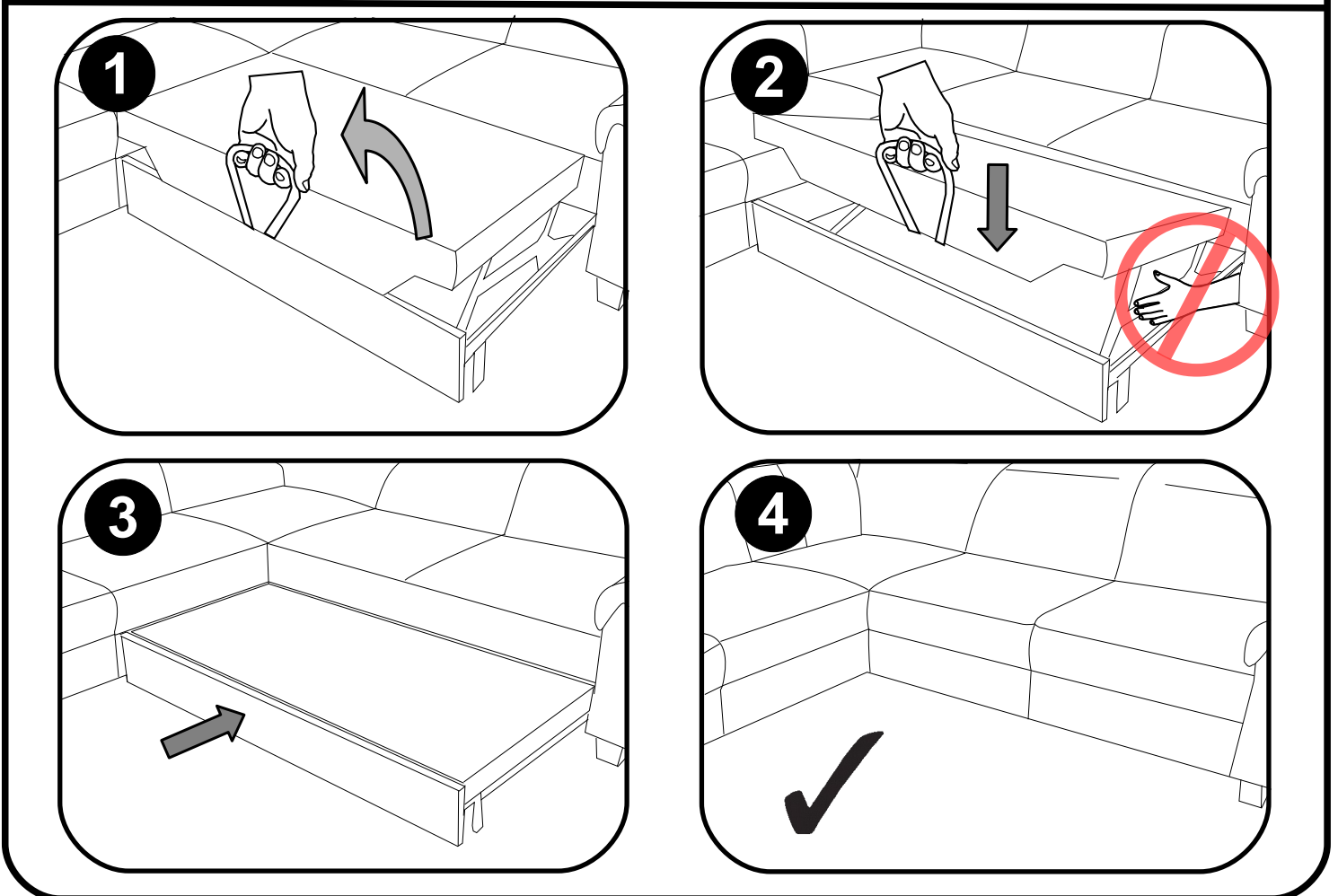
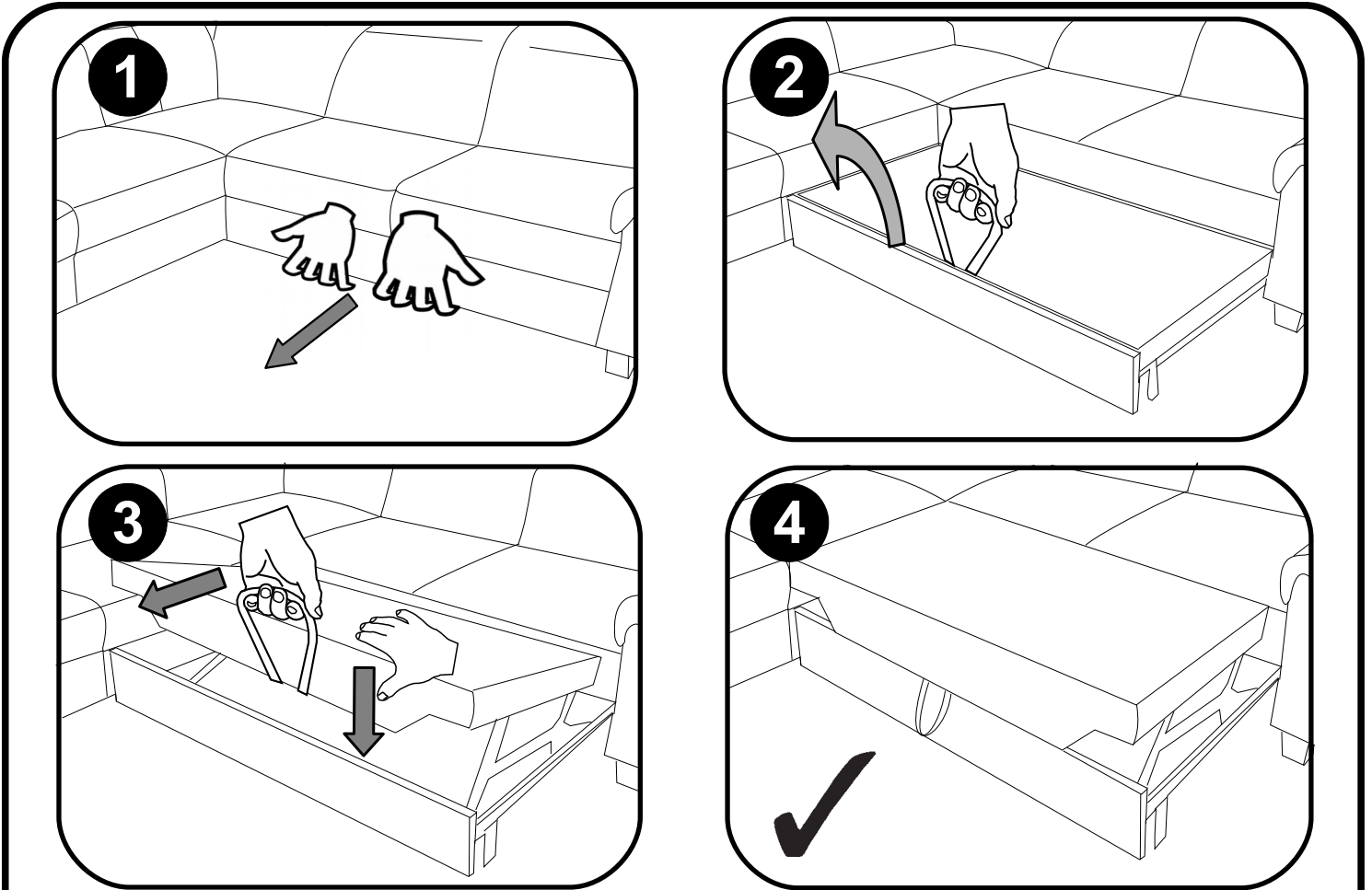
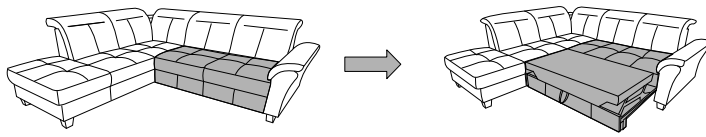



Name · Naam · Nazwa · İsim · Название · Nume · Nome · Název · Názov ·  
 Název · Neve  
**SOLVEI**  
 Typ · Type · Tip · Тип · Tipo · Típus

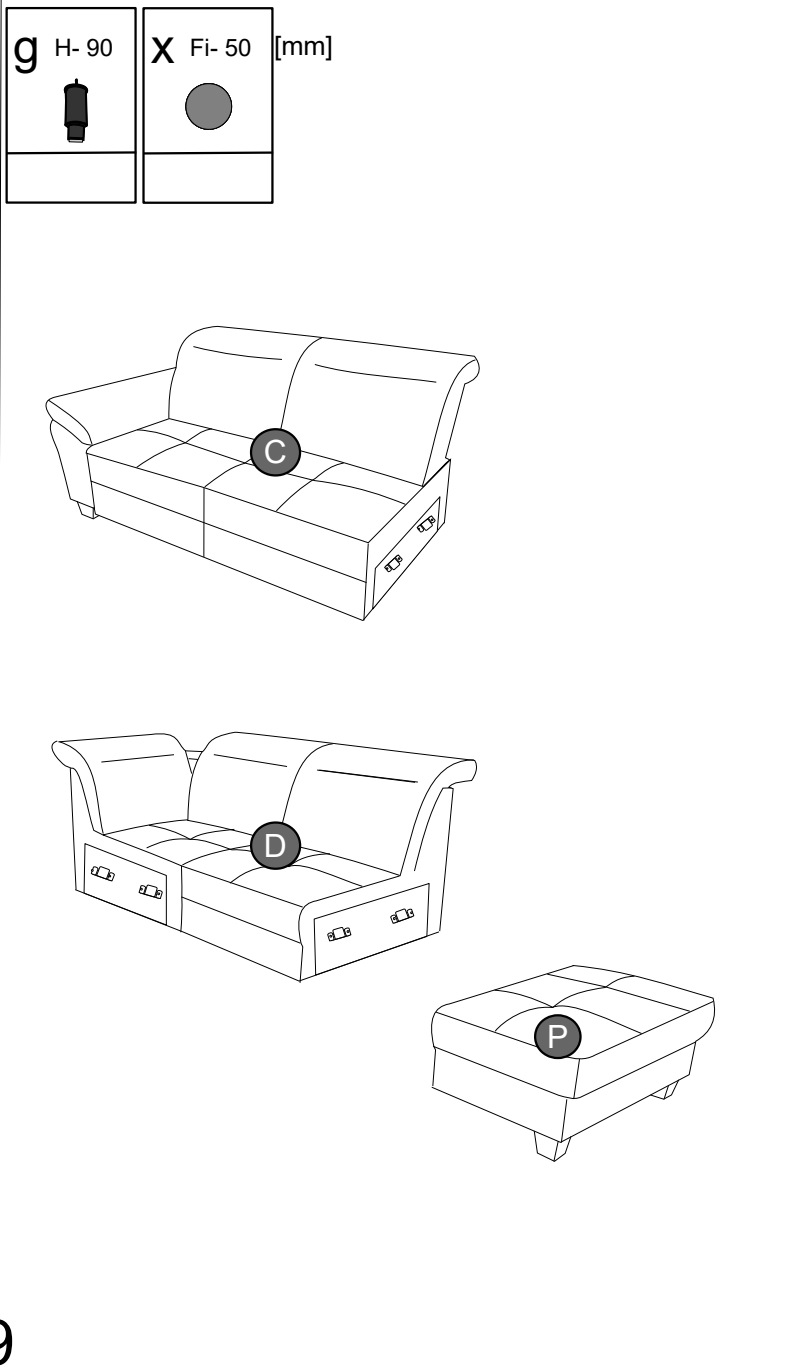
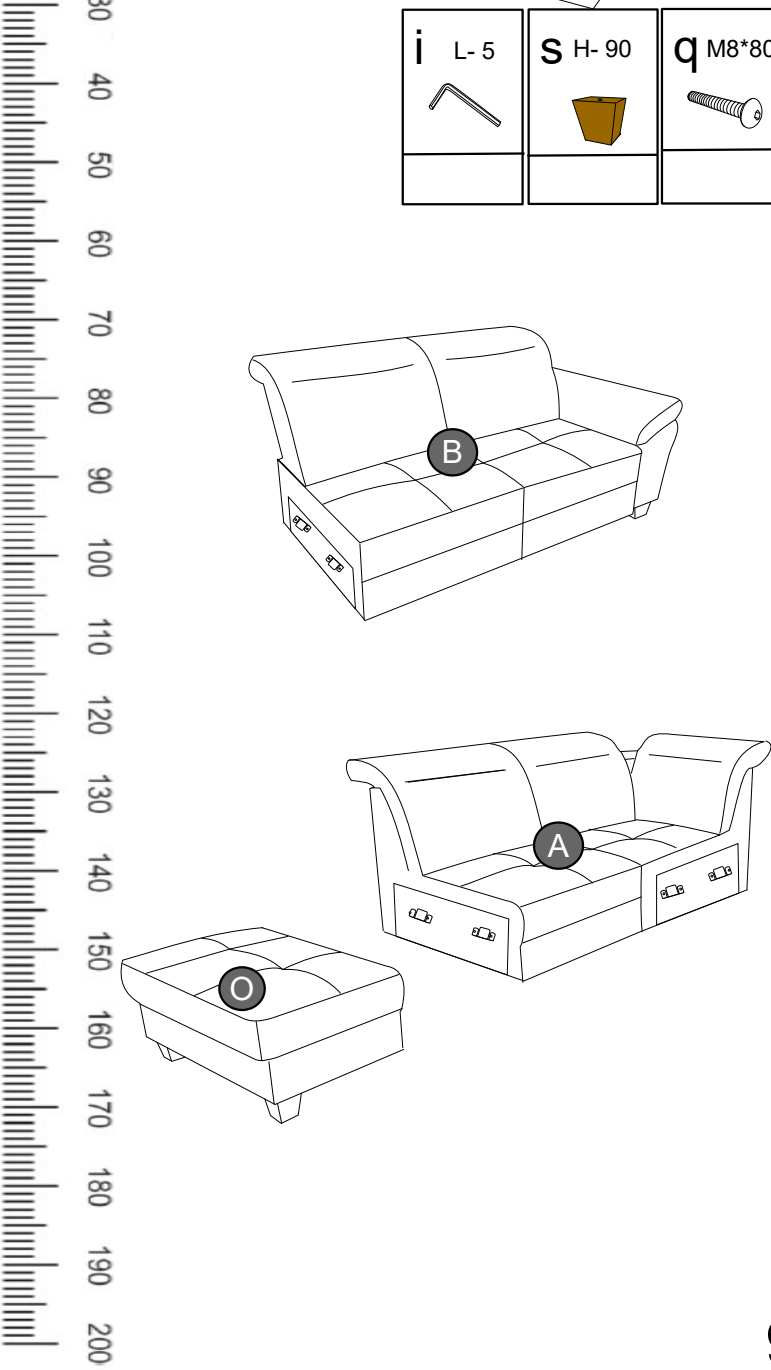
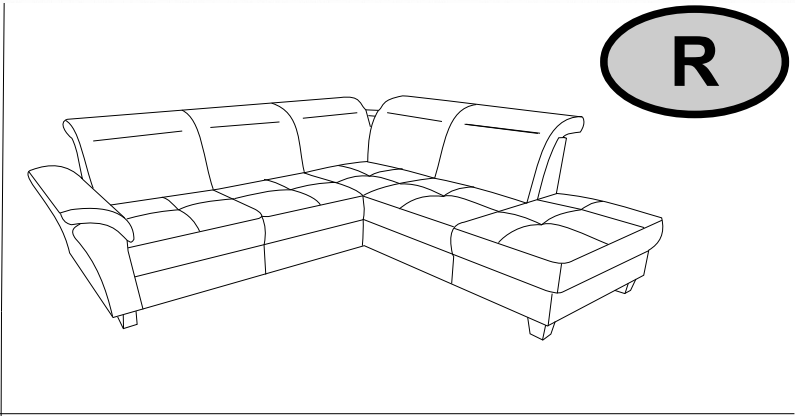
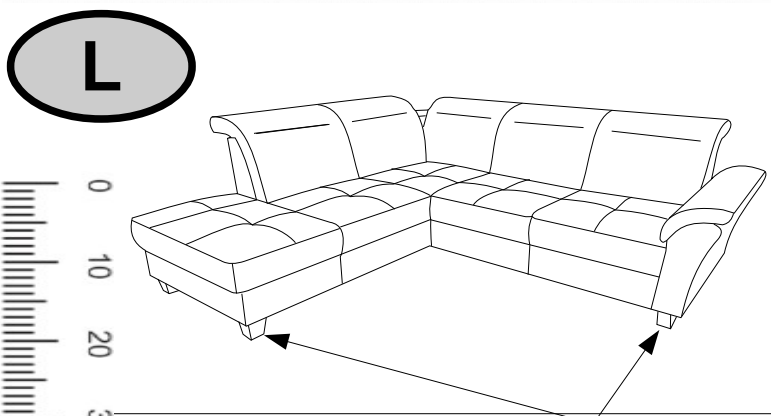
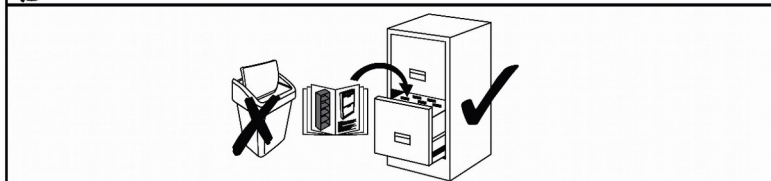
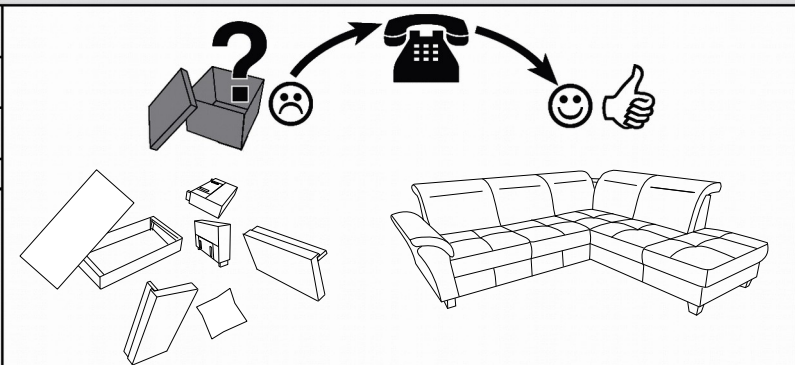

<b>i</b> L-5	<b>s</b> H-90	<b>q</b> M8*80	<b>g</b> H-90	<b>x</b> Fi-50 [mm]