

MONTAJE / MONTAGE / MONTAGGIO / MONTAGEM / ASSEMBLY / BEDIENUNGSANLEITUNG

ES TE ACONSEJAMOS

- Poner el paquete en posición horizontal.
- Ordenar y contar las piezas y herrajes.
- Habilitar una zona para el montaje.
- Sigue paso a paso las instrucciones de montaje.

FR NOUS VOUS CONSEILLONS

- Poser les colis en position horizontale.
- Classer et compter les éléments de montage et la quincaillerie.
- Définir une zone de montage.
- Suivre dans l'ordre les instructions de montage.

EN I ADVISE YOU

- Put the package in horizontal position.
- Put in the order and count the pieces and iron fittings.
- Take enough space for assembly.
- Follow step by step the assembly instruction.

IT VI INFORMIAMO

- Porre la confezione in orizzontale.
- Mettere in ordine e contare le minuterie metalliche.
- Essere certi di avere spazio a sufficienza per il montaggio.
- Seguire passo passo le istruzioni.

ES -Las herramientas que necesitas (no incluidas en el kit)

FR -Outils de montage nécessaires (not inclus dans le kit)

EN -The tools that you need for assembly (not included in the package)

IT -Gli attrezzi che vi servono per il montaggio (non inclusi nella confezione)

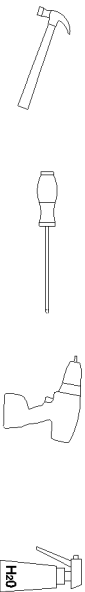

ES -Los herrajes que encontrarás en el kit

FR -Quincaillerie incluse dans le kit

EN -The tools that you will find in the package

IT -Accessori incluso nella confezione.



X 4



X 1

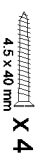

X 4



X 6

ES -Las piezas incluidas en el kit

FR -Pièces incluses dans le kit

EN -The pieces included in the package

IT -Parti incluse nella confezione

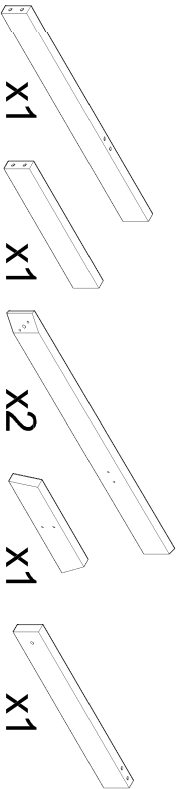

ES USO DE LAS CLAVIJAS PRE-ENCOLADAS

- Rellenar de agua la mitad del agujero con la ayuda de un pulverizador.
- Introducir la clavija.
- Rellenar de agua la mitad del segundo agujero.
- Introducir la otra parte de la clavija.
- ATENCIÓN! Cola de acción rápida.

EN USE OF PRE-GLUED PLUGS

- Fill half the hole with water with the help of a spray bottle.
- Insert the plug.
- Fill half the second hole with water.
- Insert the other part of the plug.
- ATTENTION! Fast acting glue.

FR UTILISATION DE BOUCHONS PRE-COLLÉS

- Remplissez la moitié du trou avec de l'eau à l'aide d'un vaporisateur.
- Insérez la fiche.
- Remplissez la moitié du deuxième trou avec de l'eau.
- Insérez l'autre partie de la prise.
- ATTENTION! Colle à action rapide.

IT UTILIZZO DI TAPPI PREINCOLLATI

- Riempire metà foro con acqua con l'aiuto di uno spruzzino.
- Inserire la spina.
- Riempire metà del secondo foro con acqua.
- Inserire l'altra parte della spina.
- ATTENZIONE! Colla ad azione rapida.

1



2

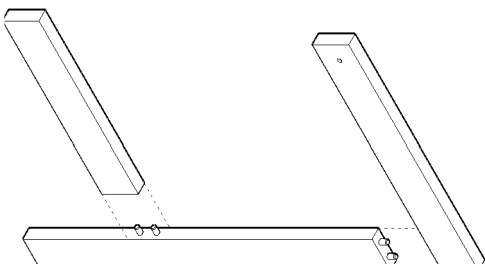

3

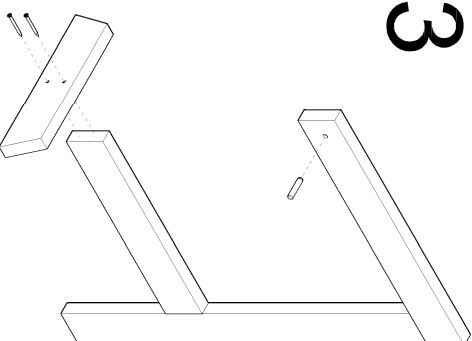

X 4

- Leer el uso de las clavijas pre encoladas.
- Read the use of the pre-glued dowels.
- Lire l'utilisation des chevilles pré-collées.
- Leggere l'uso dei tasselli preincollati.

4

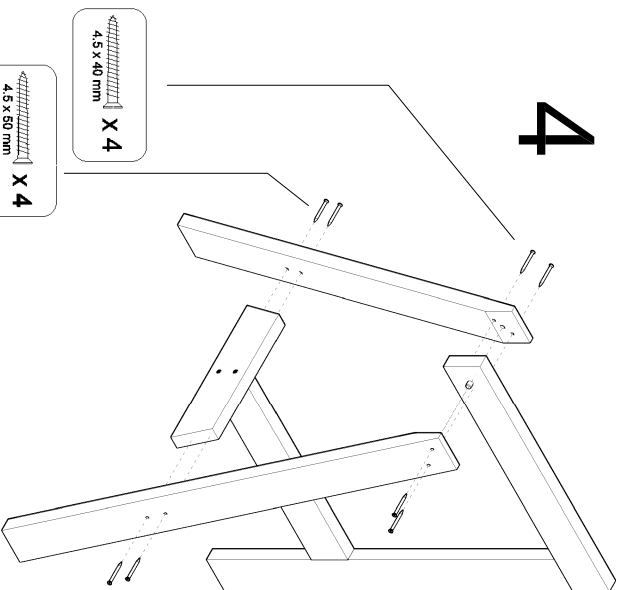

5

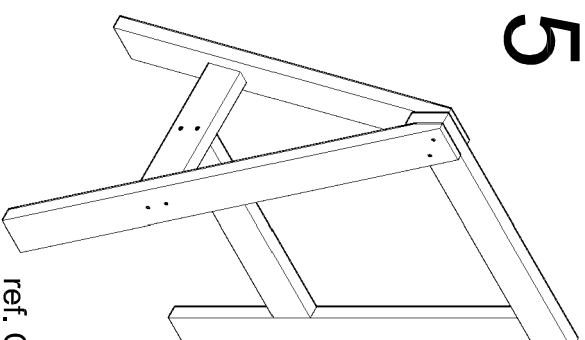

X 1

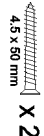

X 2

ref. CAB019.99

ASTIGARRAGA

last line

Oialde Area n°3
E-20730 Azpeitia (Gipuzkoa)
T. +34 943 814 261 | F. +34 943 816 713
astigarraga@kittline.es
www.astikittline.es

