

(D) Montageanleitung

(FR) Notice de montage

(NL) Handleiding voor de montage

(CZ) Montážní návod

(HU) Szerelési útmutató

(TR) Montaj talimatı

(GB) Assembly instructions

(IT) Istruzioni di montaggio

(PL) Instrukcja montażu

(SK) Návod na montáž

(RO) Instrucțiuni de montaj

(RU) Инструкция по монтажу

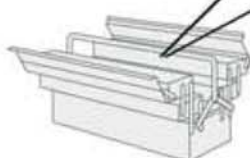
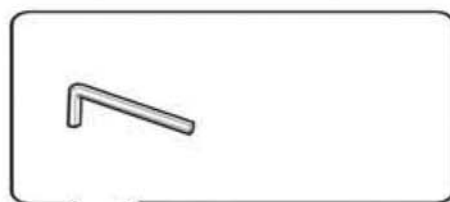
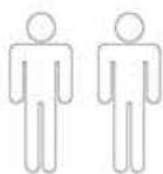

**Service • Assistenza • Dienstverlening • Serwis
Servis • Szerviz • Сервисная служба**

Name • Nom • Nome • Naam
Nazwa • Jméno • Názov •
Név
Denumire • İsim • Название

Nr. • No. • N° • Номер • Č.
Sz
2012 5436 8774 5034
3590 4855 9363 5743
6466 9710 9673 6800
8512 2644

Typ • Type • Tip • Típus •
Tipo
Тип

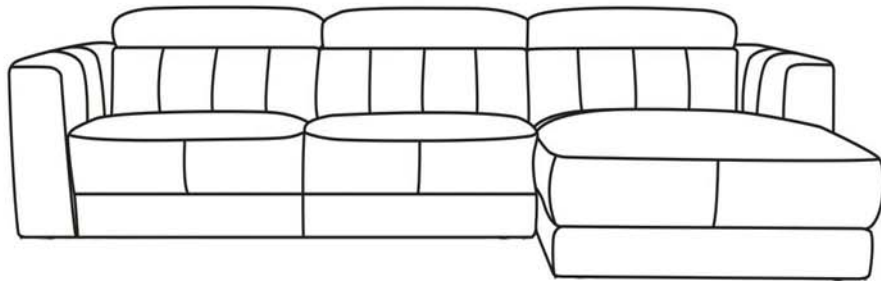
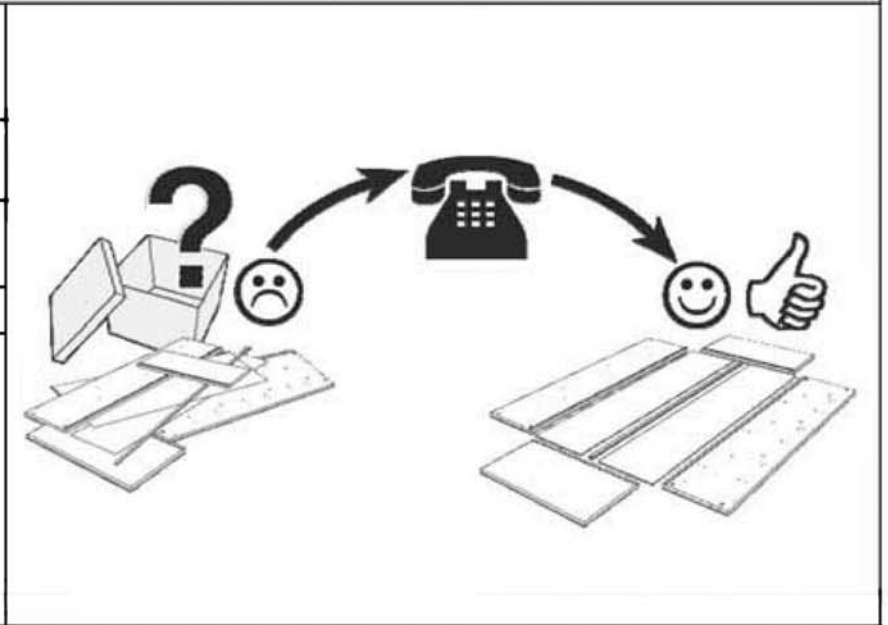
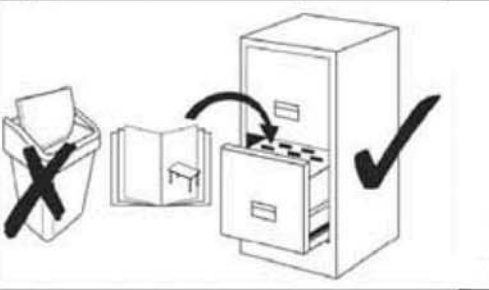

1





X8PCS

2



X2PC

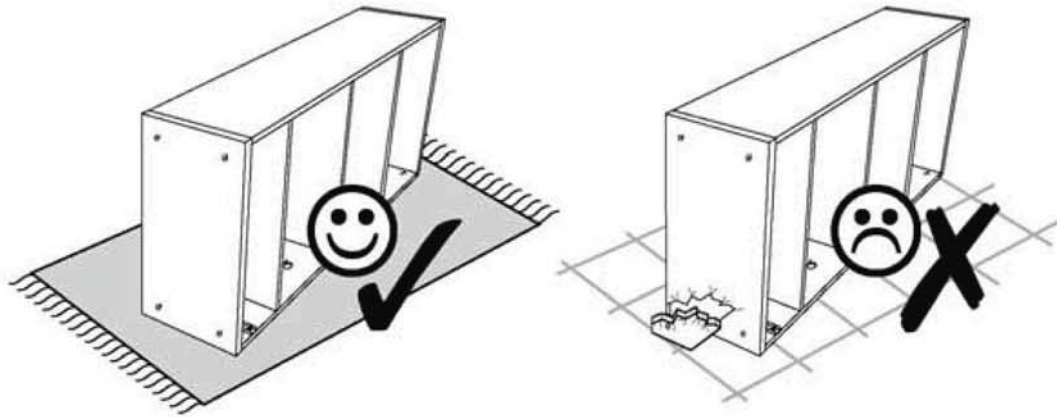

A	M10*30	B	M10*18	C	6A
					
X20		X20		X2	

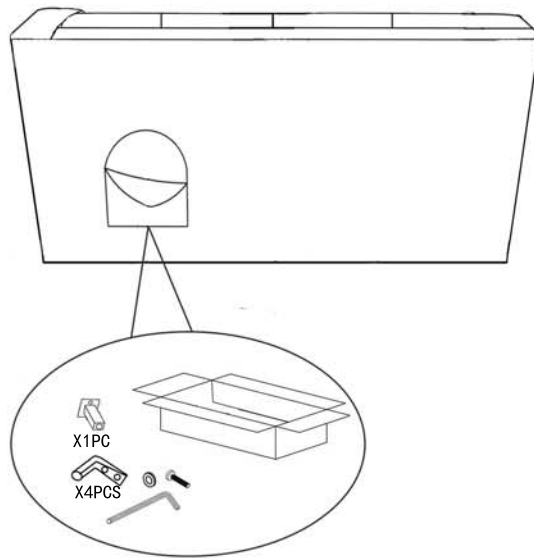

1



2

<p>A M10*30</p>  <p>X10</p>	<p>B M10*18</p>  <p>X10</p>	<p>C 6A</p>  <p>X1</p>
--	--	--

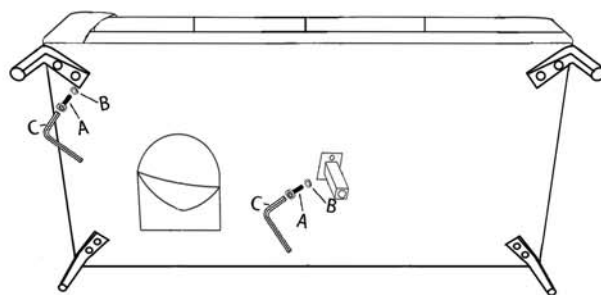

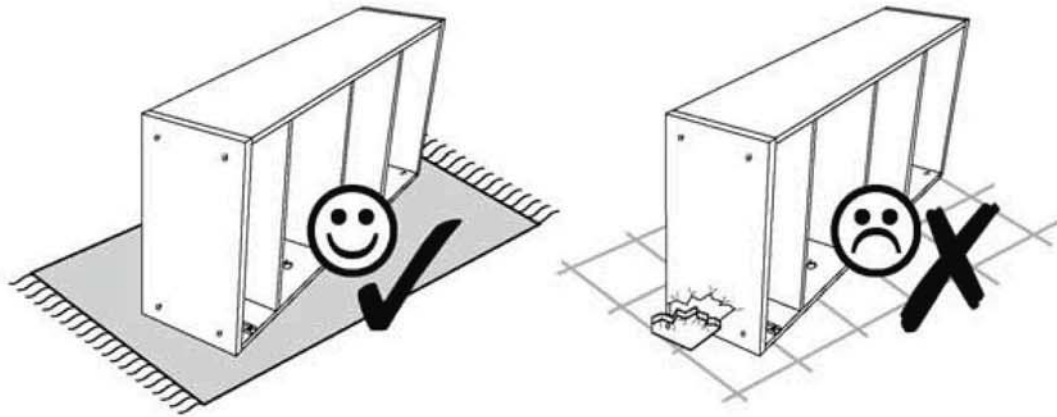

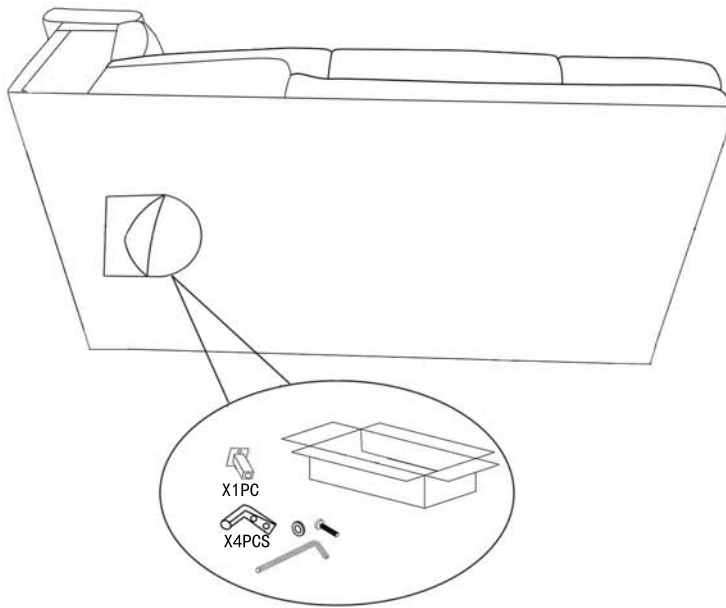

3



4

A	M10*30	B	M10*18	C	6A
					
X10		X10		X1	

