

**PAWIBBY**

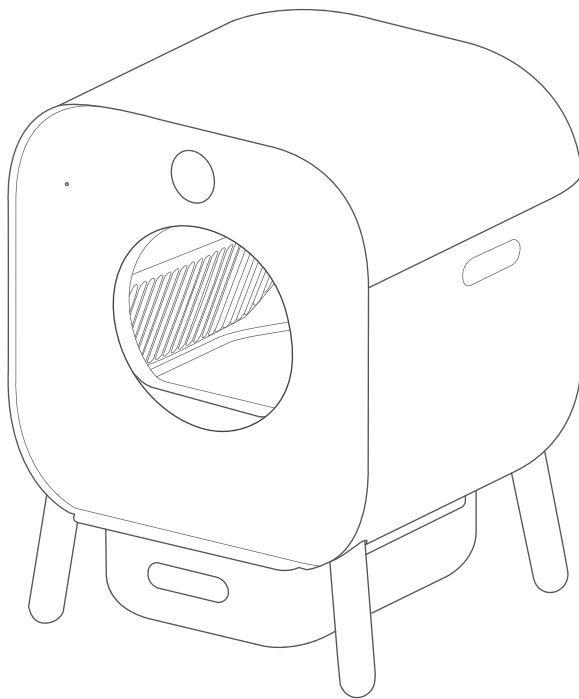

IMPORTANT SAFETY INSTRUCTIONS	01
-----	-----
Safety Instructions	02
-----	-----
Package Contents	03
-----	-----
Product Overview	04
-----	-----
How to Install	05
-----	-----
How to Use	08
-----	-----
Connect with the PAWBBY App	18
-----	-----
Daily Care & Maintenance	19
-----	-----
Cautions about deodorizing pod	21
-----	-----
Specifications	22

## IMPORTANT SAFETY INSTRUCTIONS

---

**WARNING** - When using electric appliances, basic precautions should always be followed, including the following:

Read all the instructions before using the appliance.

To reduce the risk of injury, close supervision is necessary when an appliance is used near children.

Do not contact moving parts.

Only use attachments recommended or sold by the manufacturer.

Do not use outdoors.

To disconnect, turn all controls to the off position, then remove plug from outlet.

Do not unplug by pulling on cord. To unplug, grasp the plug, not the cord.

Unplug from outlet when not in use and before servicing or cleaning.

Do not operate any appliance with a damaged cord or plug, or after the appliance malfunctions or is dropped or damaged in any manner. Return appliance to the nearest authorized service facility for examination, repair, or electrical or mechanical adjustment.

To reduce the risk of electrical shock, do not put the product in water or other liquid. Do not place or store appliance where it can fall or be pulled into a tub or sink.

## Safety Instructions

---

- Install and use the product in strict accordance with the Instruction for Use.
- Use the product for cats over six months old and weighing 1.5~8kg only.
- Don't use the product for pregnant and lactating cats, so as to avoid the danger of giving birth to kittens or leaving them in the cat litter box.
- Handle and place the product gently as there is a built-in weighing sensor. Calibrate the product by using the weighing calibration function on the Setting page of the App in the case of inaccurate weighing after handling.
- Place the product on a clean and flat hard ground and don't place any article weighing over 10kg on the lid.
- Remove the preventive expandable polyethylene between the lid and cat litter compartment before the product is powered on.
- Use the product in a cool and dry indoor environment away from fire source and direct sunlight.
- Don't place other articles under or around the cat litter box.
- Don't place other articles except cat litter mat within 25cm in front of the cat litter box.
- Contact the after-sales service personnel immediately when the power cord is bitten and damaged as there is still the risk of electric leakage even though the product operates at low voltage.
- Don't disassemble and repair the product by yourself, and contact the after-sales service personnel immediately in the case of any question in use.

## Package Contents

---

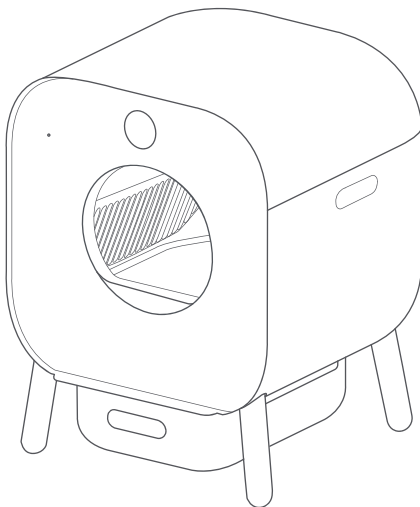

Mainframe  
× 1

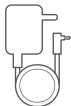

Power adapter  
× 1



Deodorizing pod  
× 1



Waste bag  
× 10



Cat litter  
mat × 1



User Manual  
× 1

# Product Overview

---

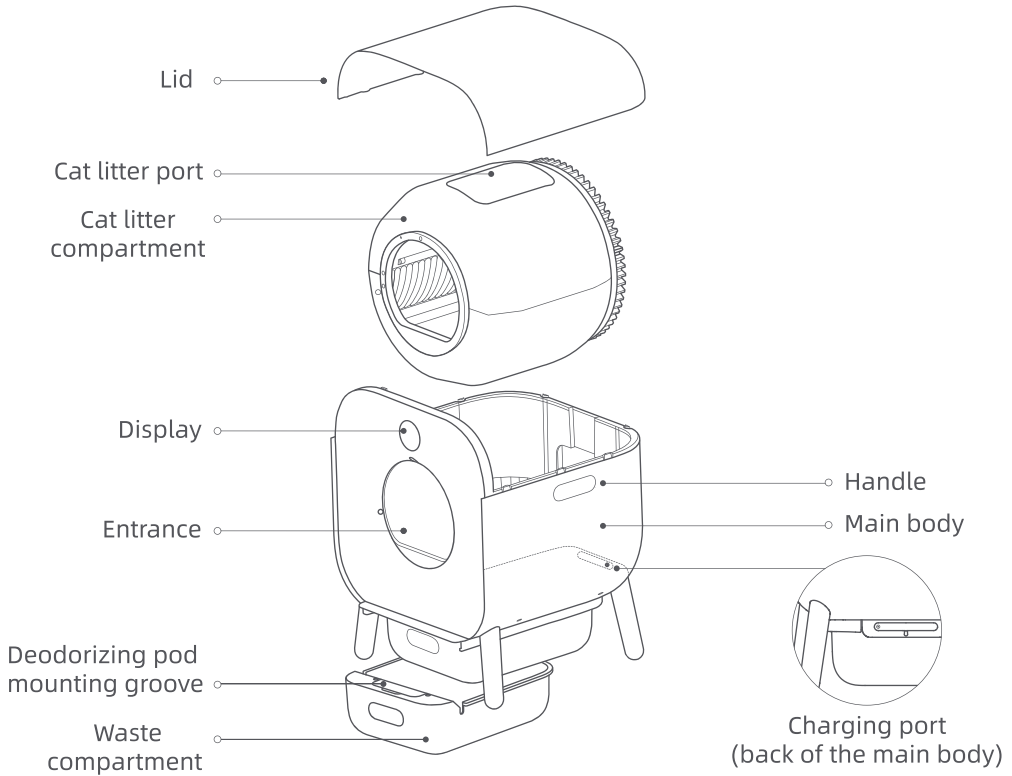

Read this manual carefully before use, and retain it for future reference.

# How to Install

---

Remove the preventive expandable polyethylene

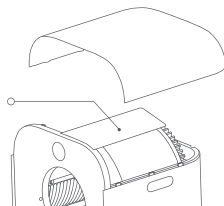

Put the power cord in the slot

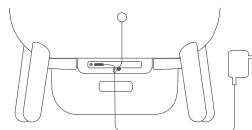

1. Remove the preventive expandable polyethylene and power on

Note: Remove the expandable polyethylene between the lid and cat litter compartment before the product is powered on.

Put the mainframe on flat hard ground and power on; the main menu will be displayed on the display after the device completes self-check.

Sealing aluminum foil Deodorizing pod installation groove

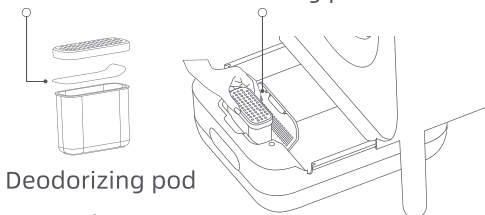

Deodorizing pod

2. Install deodorizing pod

① Open the lid of deodorizing pod, tear off the sealing aluminum foil, and cover tightly the lid.

② Open the lid of deodorizing pod installation groove, install the deodorizing pod, and cover tightly the lid, as shown in the figure.

### 3. Place the waste bag

Place the waste bag in the waste compartment, and fix it on the openings of both sides.

Note: Flatten the edge of the waste bag, or the sensing of cat litter in the waste compartment will be affected.

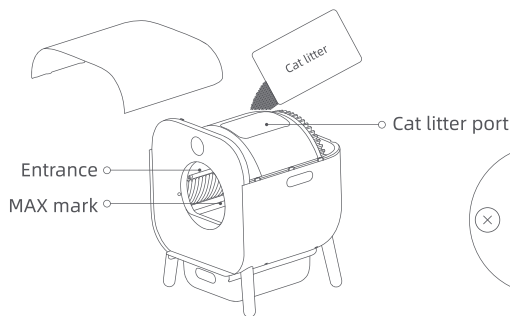
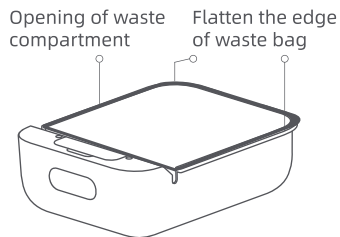

### 4. Add and flatten the cat litter

Add the cat litter via cat litter port and flatten: Remove the upper lid of the mainframe, add cat litter from the cat litter port and cover the upper lid (the product will flatten the cat litter automatically).

Add the cat litter via entrance and flatten: Add the cat litter via entrance, touch the "O" button, and choose "Flatten the cat litter", tap the "✓" button (the product will flatten the cat litter automatically after buzzing once) .



Notes: Add cat litter immediately when the display and the App remind that the cat litter is insufficient or has run out.

Ensure that the cat litter doesn't exceed the MAX mark in the cat litter compartment.

It is recommended to use deodorant natural cat litter, or bentonite bonded cat litter, tofu cat litter, mixed cat litter and other types of clumping cat litter with the diameter of less than 2mm.

## How to Use

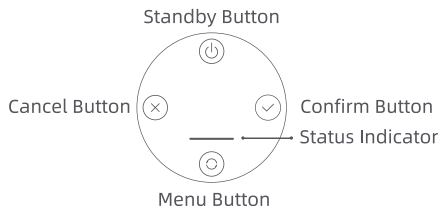

---



### On/Standby:

The device starts automatically after it is powered on. In daily use, press and hold “” for three seconds to power on or enter standby. Please disconnect the power cord if the product is not used for a long time.

### Menu functions:

Tap the “” button to enter and switch menu, “” button to confirm to execute the selected function, and “” button to exit the existing menu and back to the previous.



### Enable/Disable child lock:

The child lock function can be enabled/disabled in the App. After this

feature is enabled, there will be locking icon on the display, and it is impossible to operate via keys on the display.

Press and hold “ ✓ ” and “ × ” on the display simultaneously for two seconds to disable the child lock.



#### Connect Wi-Fi:

Tap the “ ○ ” button, select “Connect Wi-Fi” , and tap the “ ✓ ” button, “ ” flashes and the device starts connecting to Wi-Fi.

#### Disable Wi-Fi:

Tap the “ ○ ” button, choose “Connect Wi-Fi” , tap and hold the “ ✓ ” button for five seconds, and release when the product buzzes, the Wi-Fi is disabled if the screen displays “ ✕ ” .

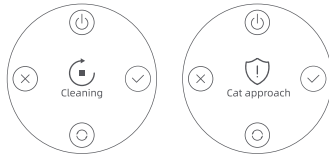

### Auto-cleaning:

After the cat defecates and leaves, the display starts countdown and the product will clean automatically after countdown.

Note: The product will immediately suspend cleaning if it detects a cat approaching or entering the cat litter compartment during auto-cleaning, and will resume cleaning after the cat leaves for a period of time.

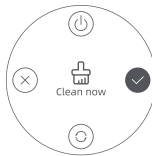

### Manual cleaning:

After "Clean now" in the menu is chosen, the product buzzes once and starts cleaning.



Clean the waste compartment and replace the waste bag:

Please clean the waste compartment and replace the waste bag immediately when the status indicator flashes in orange, and the display and the App remind that the waste compartment is full.

Note: For example, when it is used by one cat, it is recommended to replace the waste bag every 14 days, or every seven days in hot weather to avoid breeding mosquitoes.



Empty cat litter:

After "Empty cat litter" in the menu is chosen, the product will buzz once and automatically pour the cat litter in the cat litter compartment into the waste compartment.

## Menu functions

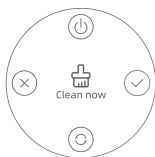

**Clean:**  
Choose to clean the  
cat litter manually



**Connect Wi-Fi**  
**Disable Wi-Fi**



**Empty cat litter:**  
Pour all cat litter in cat litter  
compartment into the  
waste drawer



**Restoring factory settings:**  
Clear all settings



**Flatten cat litter:**  
Flatten the newly  
added cat litter

## Status reminder



Sufficient  
cat litter

Insufficient  
cat litter

Cat litter  
depleted

🔒: Child lock status    📶: Network status

🐾: Total defecation times of the cat in the current day

(The real-time remaining cat litter may slightly deviate for  
different types of cat litter)



Weight: 5kg

Real-time weight of cat in the cat litter box



Cat approach:

The product suspends automatically and gives prompt if the cat approaches or enters the cat litter box during standby or cleaning

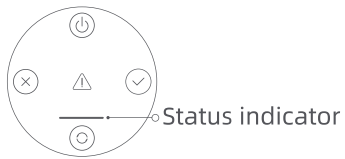

Status indicator flashes in orange or is always on:  
The product cannot clean normally due to error, or the cat defecates too often or too less



Lid not closed:  
Please check whether the upper lid is properly covered



Waste compartment removed:  
Please check if it's properly installed





Compartment uninstalled:

Push the roller-shaped cat litter compartment left and right after placing it back. It is normally installed if it cannot roll.

Take the following steps for weighing calibration:

1. Select “Empty cat litter” on the display, and tap “ ✓ ” .
2. Complete calibration when the cat litter compartment is emptied and rotates to the initial position.

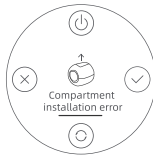

Compartment installation error:

Push the roller-shaped cat litter compartment left and right after placing it back. It is normally installed if it cannot roll.

If the aforesaid solutions don't work,  
please contact us at [support@pawbby.com](mailto:support@pawbby.com)

## Instructions for Error codes on the display



Error code: W00

Instruction: The mainframe tilts or falls down.

Solution: Place the cat litter box on clean and flat ground without any other articles placed beneath it.

Error code: W01

Instruction: The cat litter compartment fails to rotate, or cannot rotate flexibly.

Solution: Take the following steps:

1. Take out the cat litter Roller, clean outer matters on the surface and around the motor gear, and re-install it back.
2. Unplug for 3 seconds and then plug it back in, wait for it to turn on automatically.
3. Download the PAWBBY APP, connect to the cat litter box, and upgrade the firmware to the latest version as suggested by the pop-up window.

Error code: W03

Instruction: The cat litter compartment is overweight.

Solution: Take the following steps for weighing calibration:

1. Select "Empty cat litter" on the display, and tap "✓".

2. Complete calibration when the cat litter compartment is emptied and rotates to the initial position.

Error code: E01、E02、E04、E05、E06、E09

Instruction: Component failure.

Solution: Contact us at [support@pawbby.com](mailto:support@pawbby.com)

## Connect with the PAWBBY App

---

### App download and device pairing

Scan the QR code to download and install PAWBBY App. Users who have installed the PAWBBY App will be directed to the connection setup page . Or search "PAWBBY" in the app store to download and install PAWBBY App.

### App functions

Remote cleaning, abnormal warning, viewing cat defecation data, setting DND mode at night, electronic user manual, and FAQ.

Notes: Due to upgrades of the PAWBBY App, actual operations may be slightly different from what are mentioned above, please operate according to the instructions for the current PAWBBY App.



## Daily Care & Maintenance

---

### · Product cleaning

Note: It is recommended to clean the product once a month to ensure cleanness and health.

① Empty cat litter as previously stated.

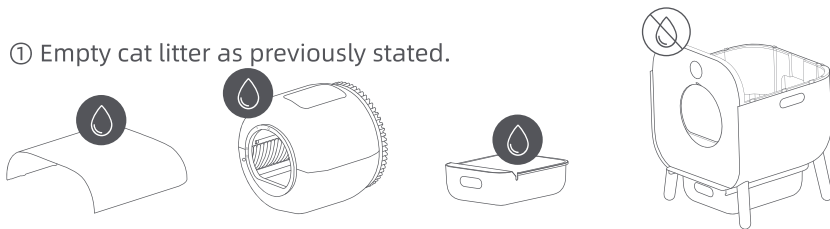

② Power off the product and disconnect the power supply, remove the upper lid, cat litter compartment and waste compartment successively, and clean all the components.

Note:

Wash the upper lid, cat litter compartment and waste compartment with water.

To ensure accurate sensing at entrance and waste compartment, please wipe the infrared sensors at the entrance and cat litter port regularly.

Cautions:

Don't wash the main body with water, as there are electrical elements.

Wipe the main body with neutral detergent by wet duster cloth, and don't use any detergent that contains alcohol and chemical reagent.

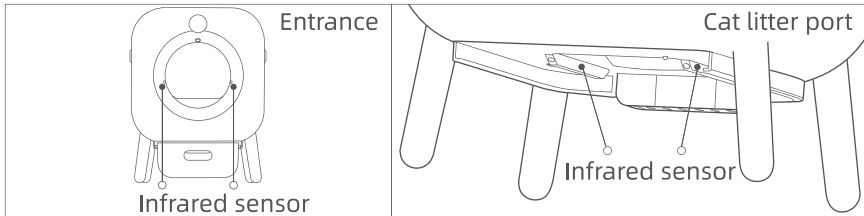

③ After cleaning, air dry various the components, and install the waste compartment, cat litter compartment and upper lid in order.

**Note:**

After installation, if the status indicator flashes, please check whether the components are properly installed, as the status indicator goes out if the components are properly installed.

- Use special waste bag attached to ensure efficient cleaning.
- It is recommended to use deodorant natural cat litter to ensure efficient cleaning.
- Use special deodorizing pod attached to ensure efficient deodorizing and avoid damage of the product.

## Cautions about deodorizing pod

---

- Don't eat the beads in the deodorizing pod. Seek medical service immediately if the beads are eaten by mistake.
- Please use and store the deodorizing pod in places not accessible by children or pets.
- Don't use the deodorizing pod for any other purpose.
- Wipe any beads spattered from the deodorizing pod immediately.
- Don't pour the beads in the deodorizing pod into the sewer, otherwise, the sewer may be blocked.
- Note that the beads in the deodorizing pod may change into yellow if they are placed there for a long time, which is normal and is not a quality problem.
- Wash your skin thoroughly if it is exposed to the beads.
- Thaw the beads in the environment over 0°C before use as the beads may be frozen when the temperature is lower than 0°C.

## Specifications

---

Name	PAWBBY Smart Self-cleaning Cat Litter Box
model	MG-CLB001-US
Rated Input	12V $\overline{\text{---}}$ 1.5A
Rated Power	18W
Net Weight	13.6kg
Power cord length	1.8m
Dimensions	496 × 500 × 640mm
Operating Temperature	4°C to 40°C
Operating Humidity	30%–70% RH
Capacity of waste compartment	8.6L

## Power Adapter

Model Identifier	YJS018Z37-1201500G	Output Current	1.5 A
Input Voltage	100–240 V AC	Output Power	18 W
Input AC Frequency	50/60 Hz	Output Voltage	12.0V



Official Website: [www.pawbby.com](http://www.pawbby.com)

Customer Service: [support@pawbby.com](mailto:support@pawbby.com)

Manufacturer: Beijing Kitten&Puppy Technology Co., Ltd.

Address: Room Q-101, Floor 2, Q Area, Anning Zhuang Back Street,  
Haidian District, Beijing, China