

	A	B	C1	C2	C3	D
1	M232-0001	1156	296	16	3/3	
2	M232-0002	756	296	16	3/3	
3	M232-0003	1916,	496	19	3/3	
4	M232-1001	1888	367	16	2/3	
5	M232-1002	1888	367	16	2/3	
6	M232-1003	1888,	347	16	2/3	
7	M232-2001	801	368	16	1/3	
8	M232-2002	801	367	16	1/3	
9	M232-3001	475,	347	16	1/3	
10	M232-3002	275	347	16	1/3	
11	M232-3003	476	347	16	1/3	
12	M232-3004	276	347	16	1/3	
13	M232-9001	1898,	289	2,5	3/3	
14	M232-9002	1898,	489,	2,5	3/3	

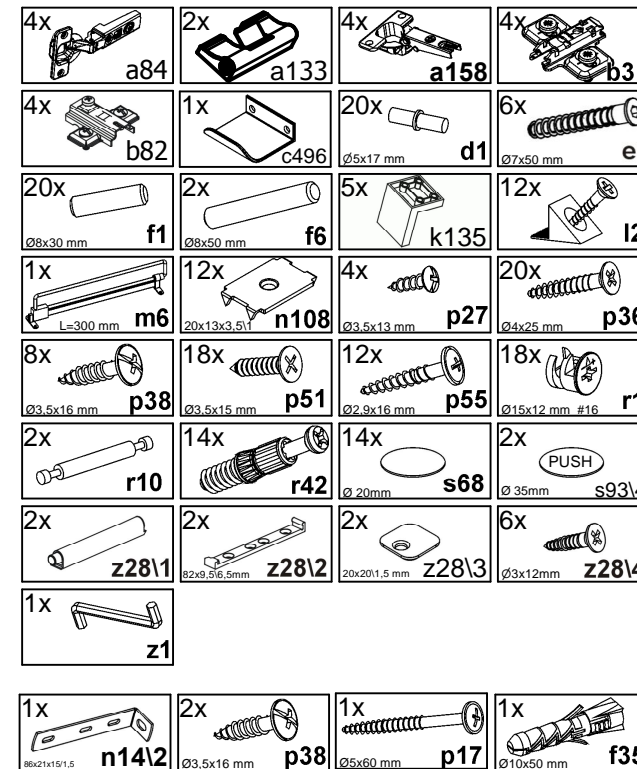

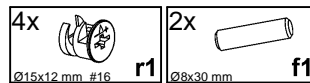

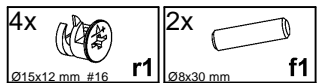
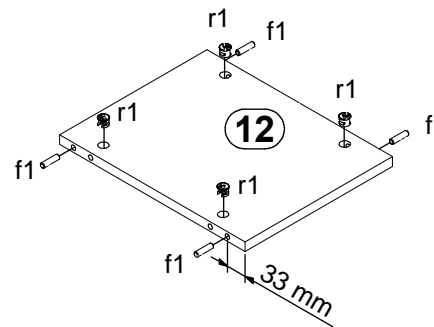
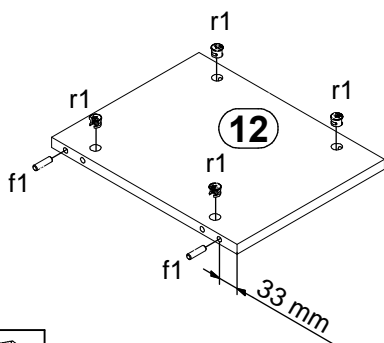
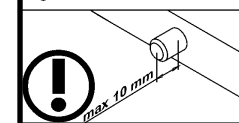
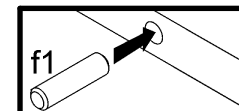
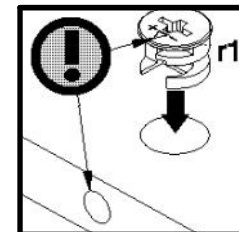
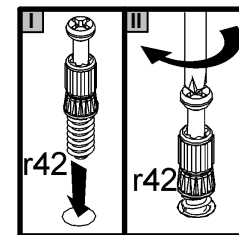
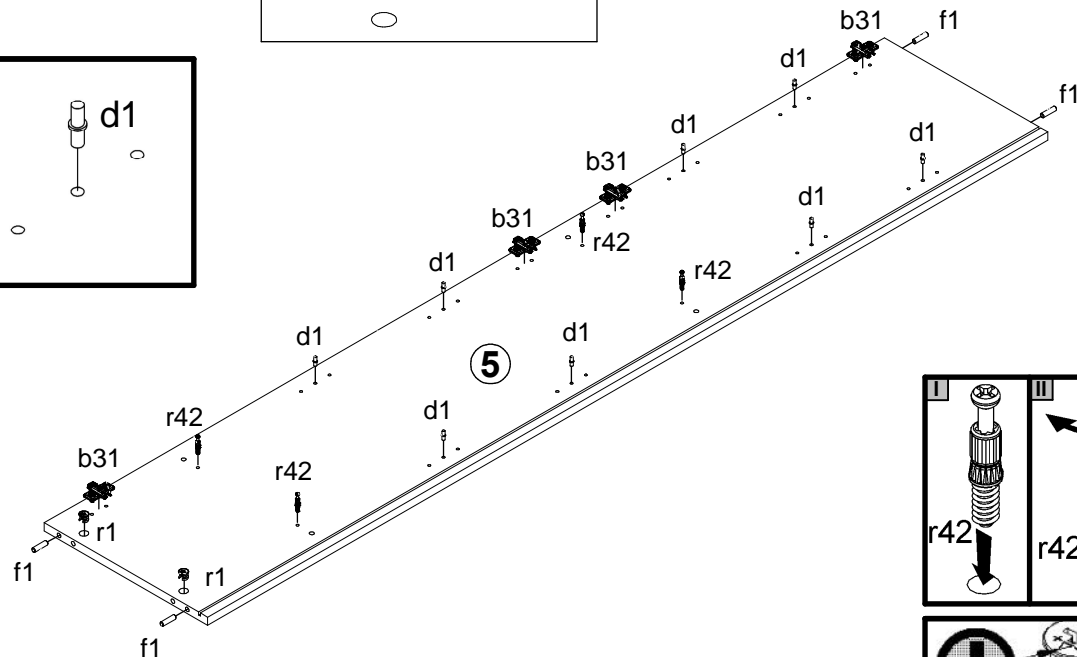
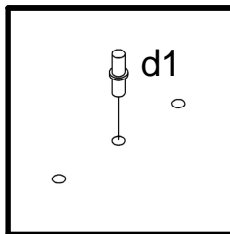
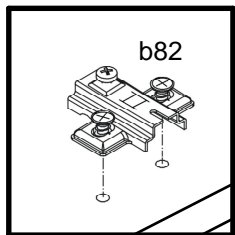
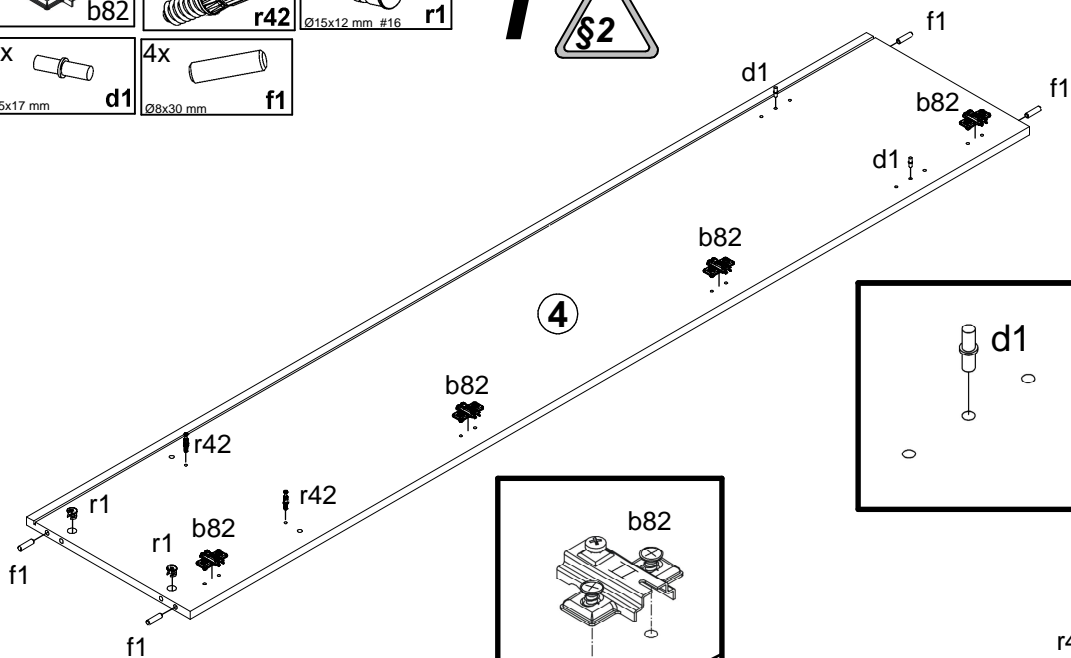
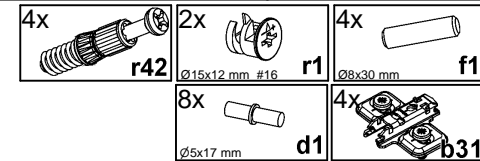
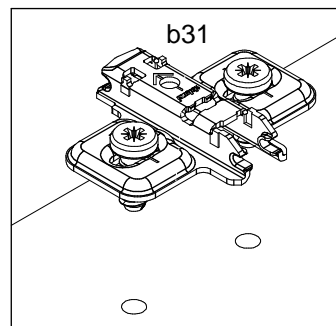
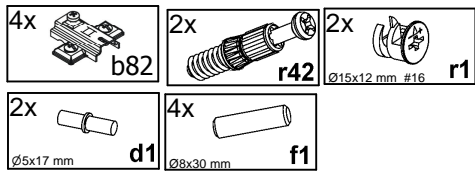
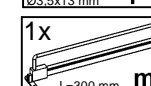
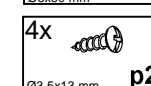
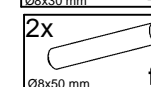
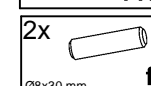
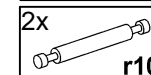
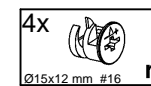
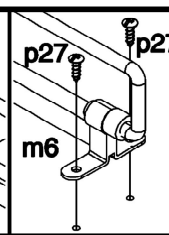
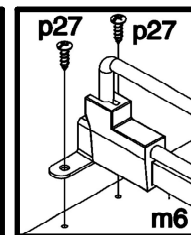
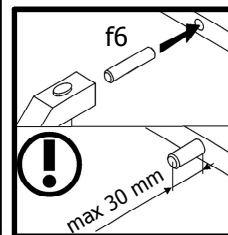
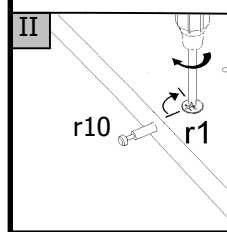
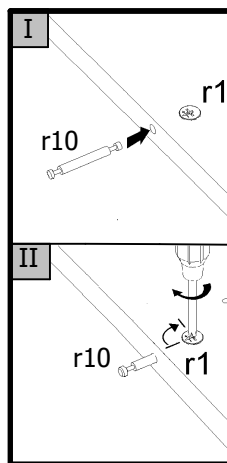
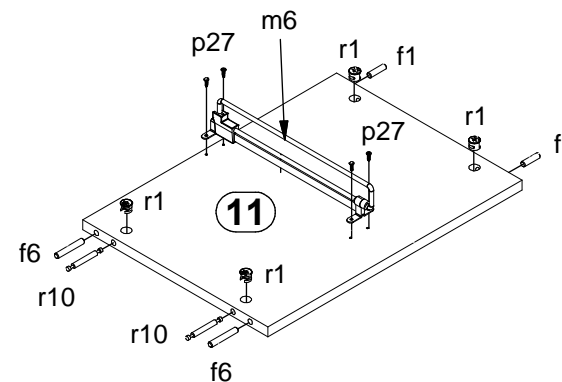
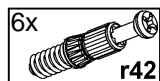
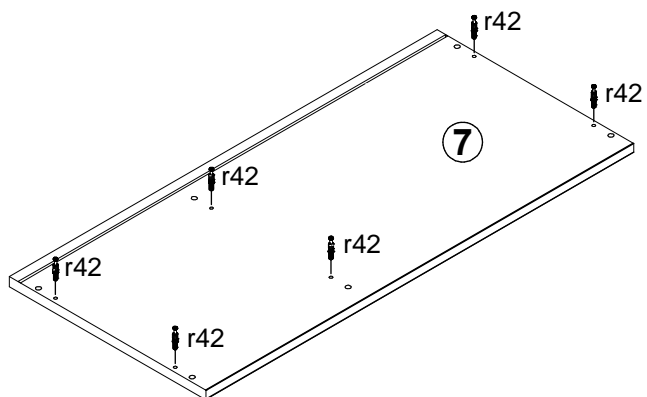
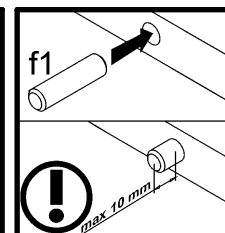
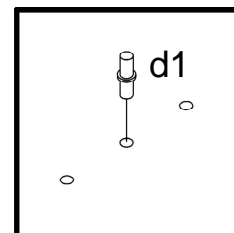
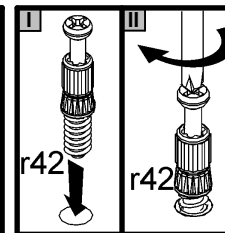
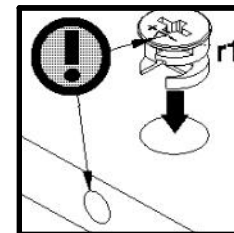
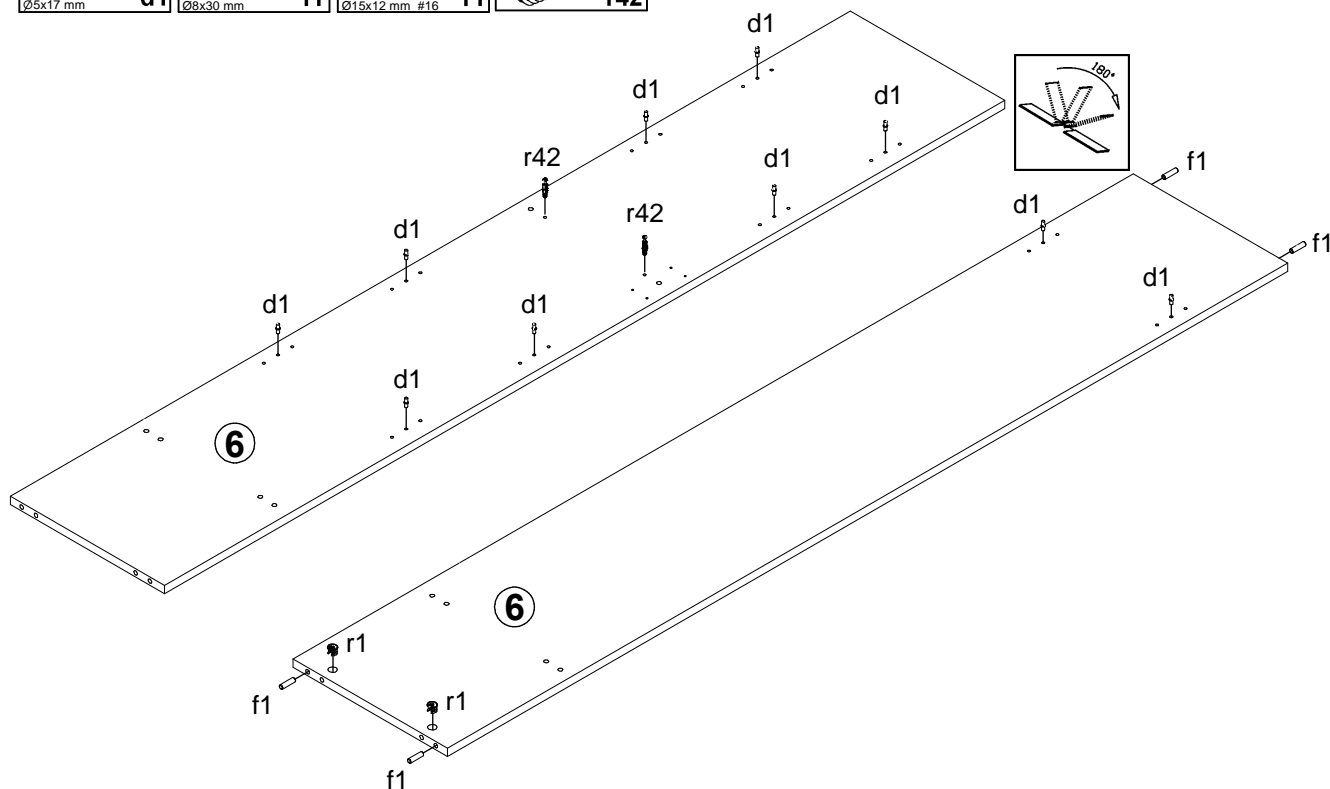
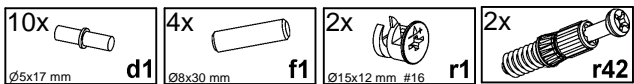

1

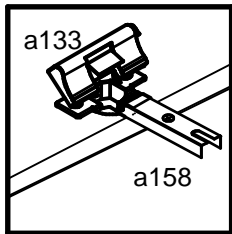
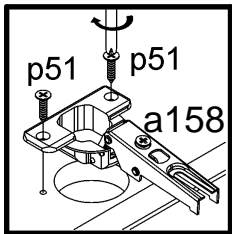



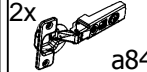
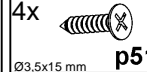

1

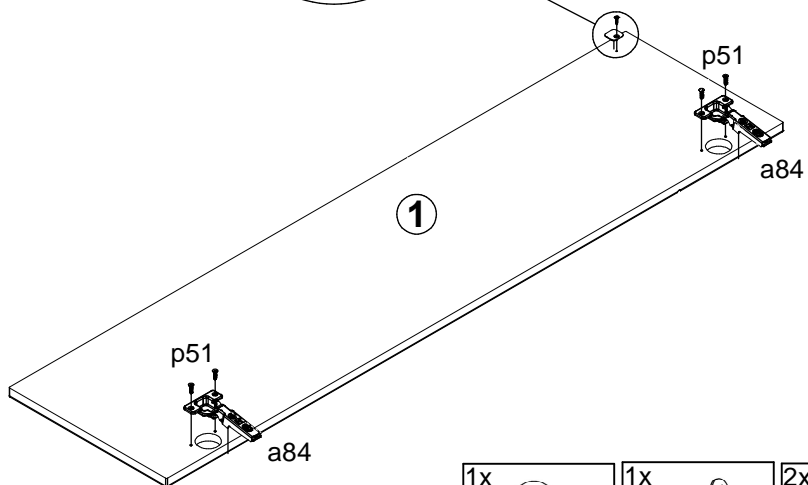
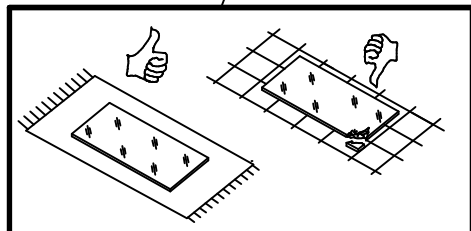
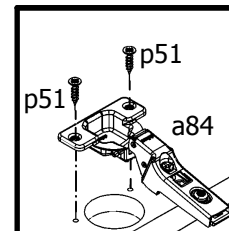
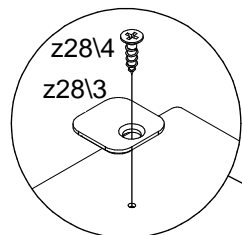
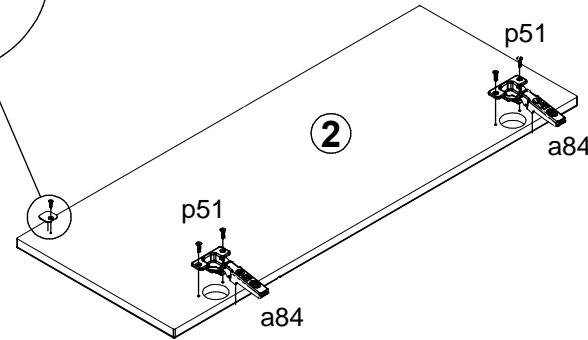
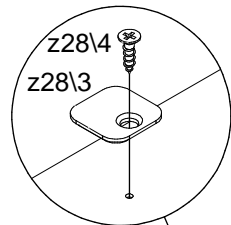
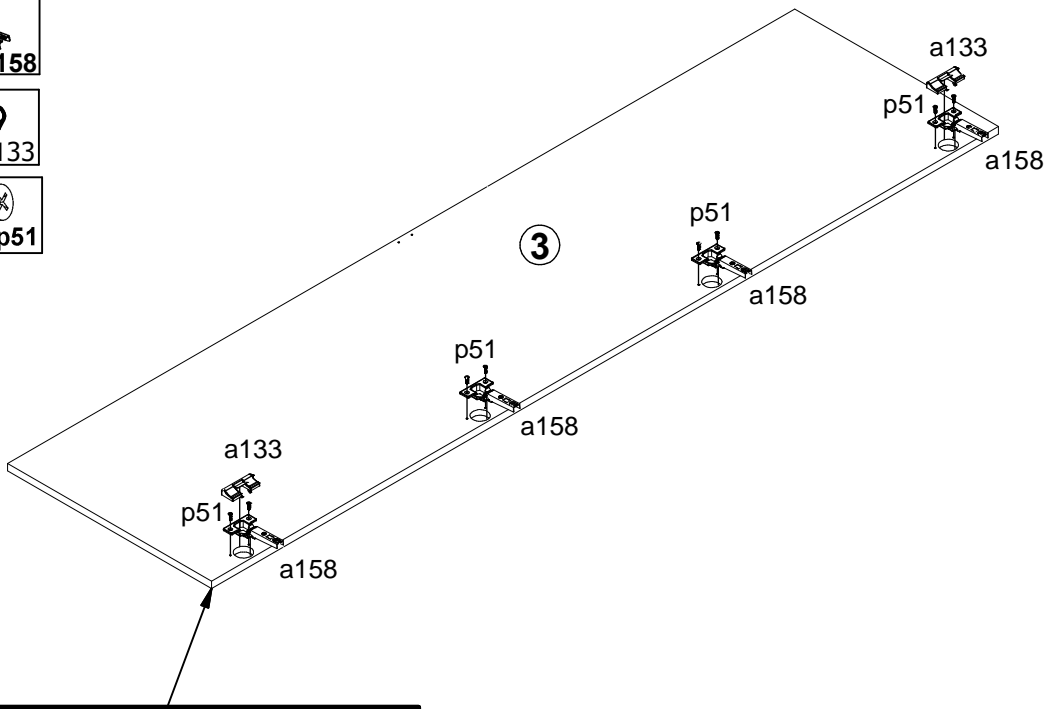
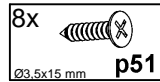
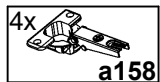
- 1x

20x20\1,5 mm z28\3
- 1x

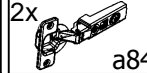
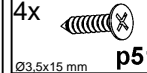
Ø3x12mm z28\4
- 2x

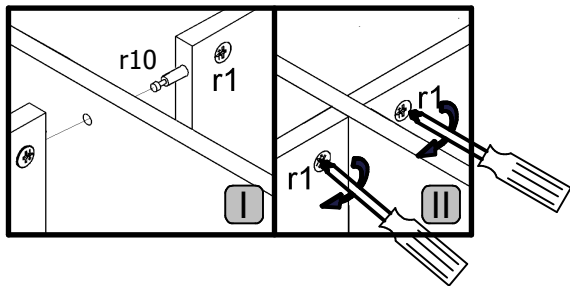
a84
- 4x

Ø3,5x15 mm p51

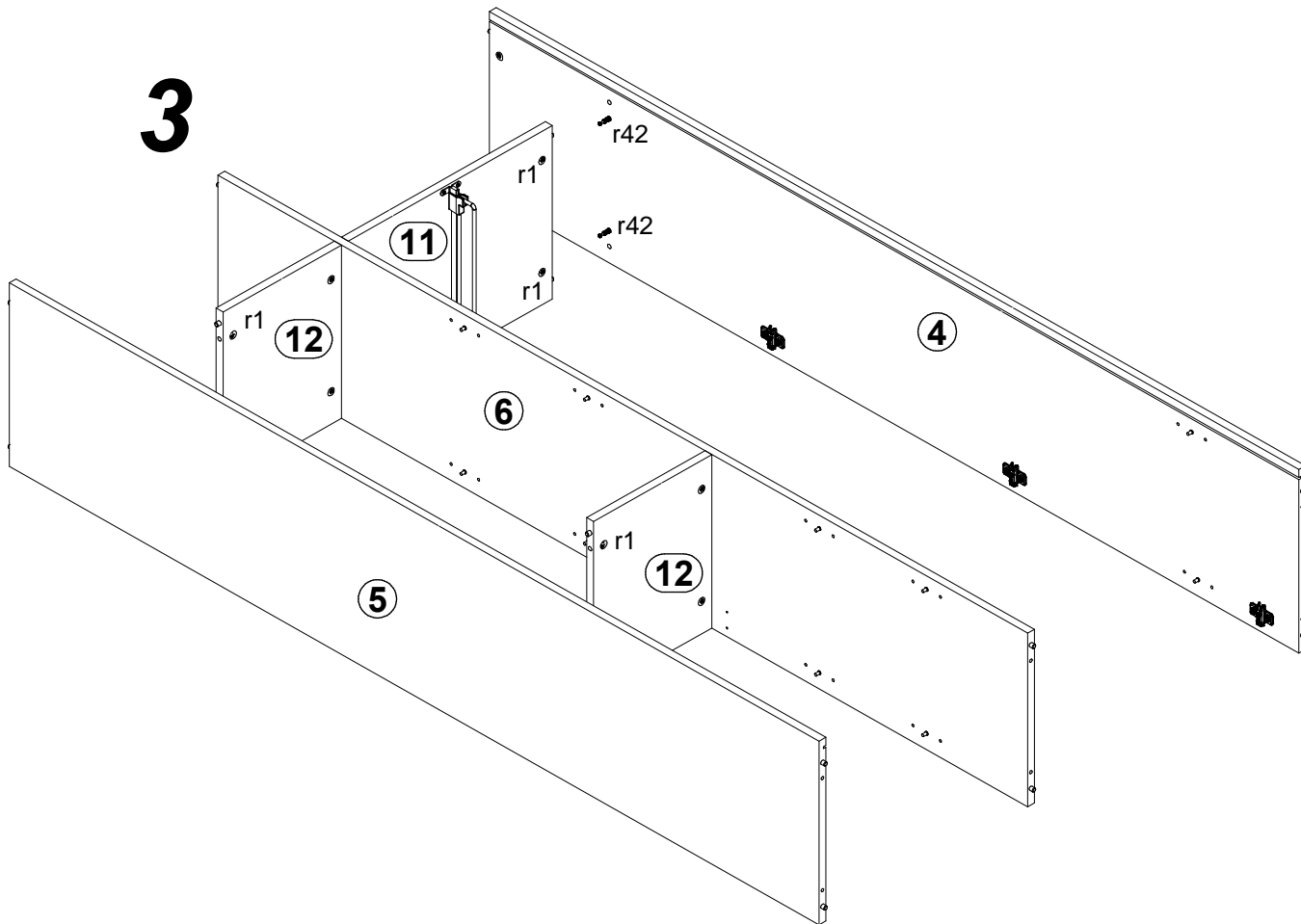

- 1x

20x20\1,5 mm z28\3
- 1x

Ø3x12mm z28\4
- 2x

a84
- 4x

Ø3,5x15 mm p51



3



2

