

22-048-V1-7
22-049-V1-7

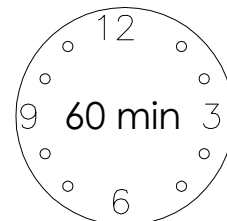

BETT

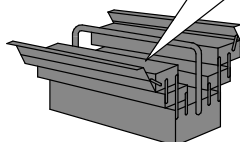
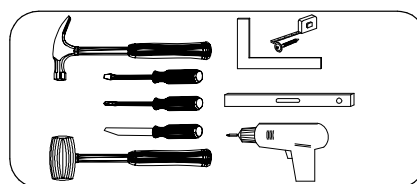
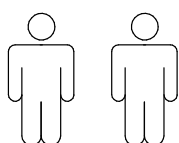
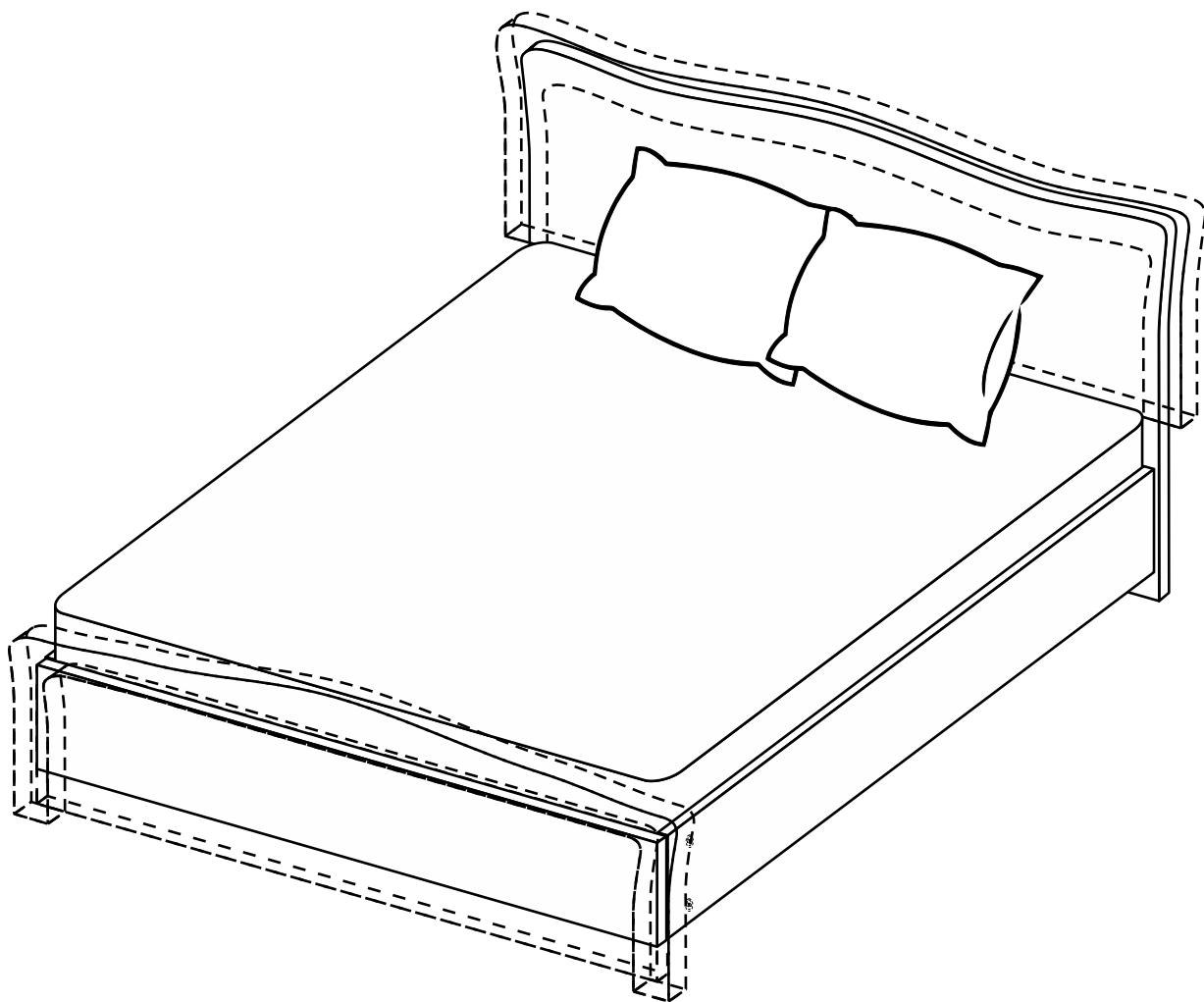

1

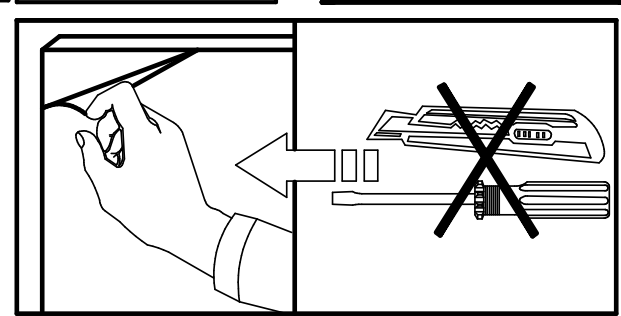
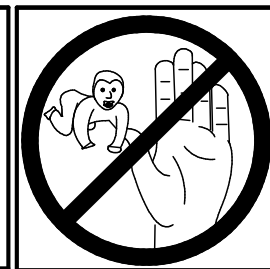
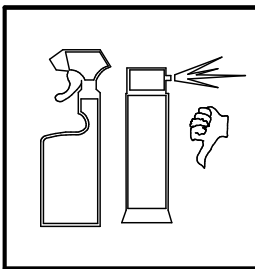
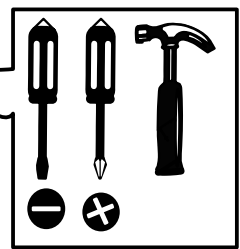
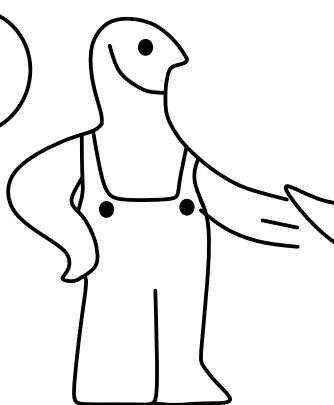

2

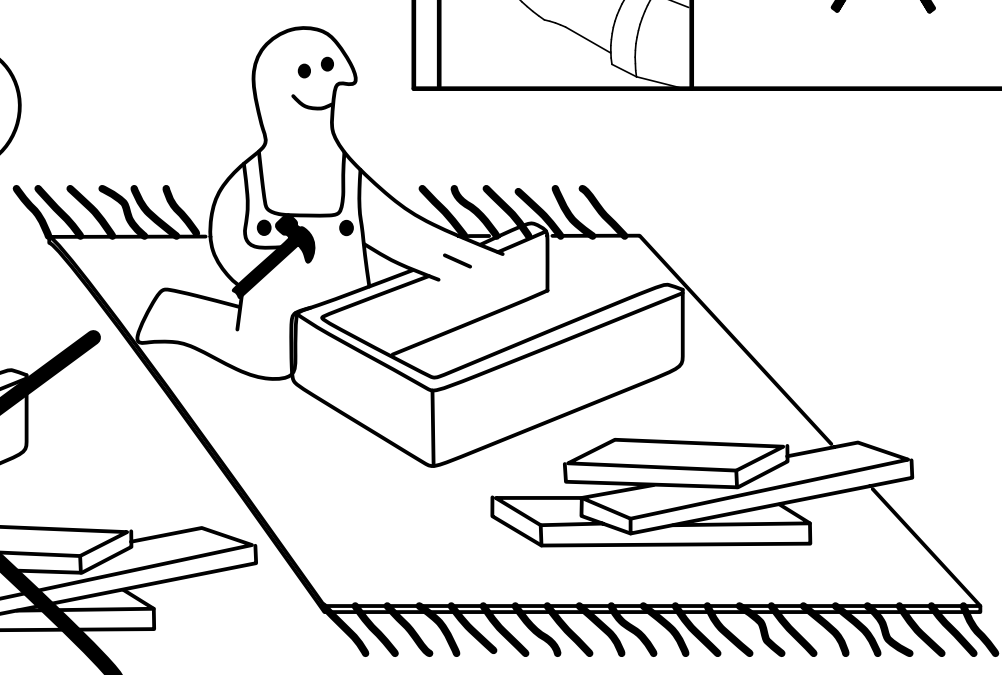
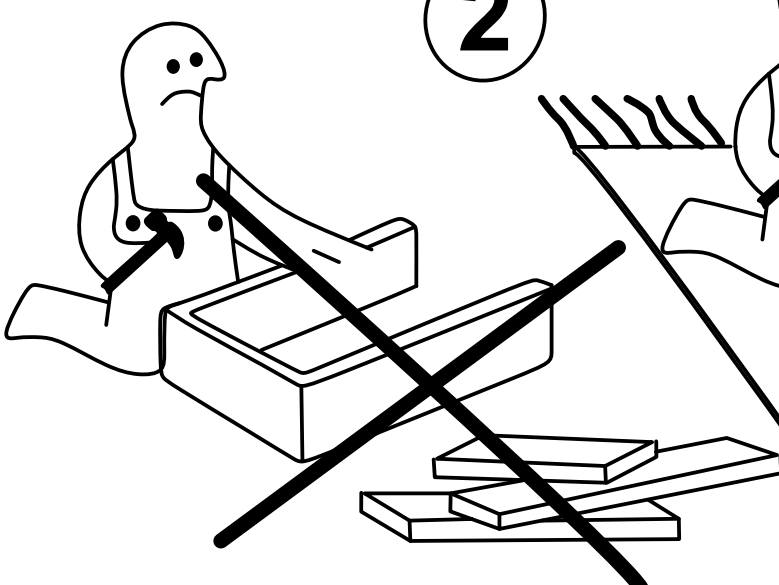

3

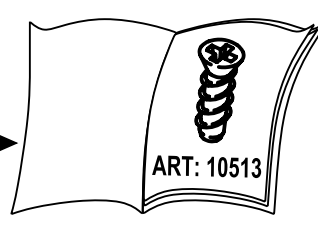

4

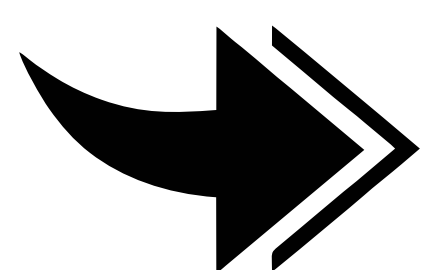
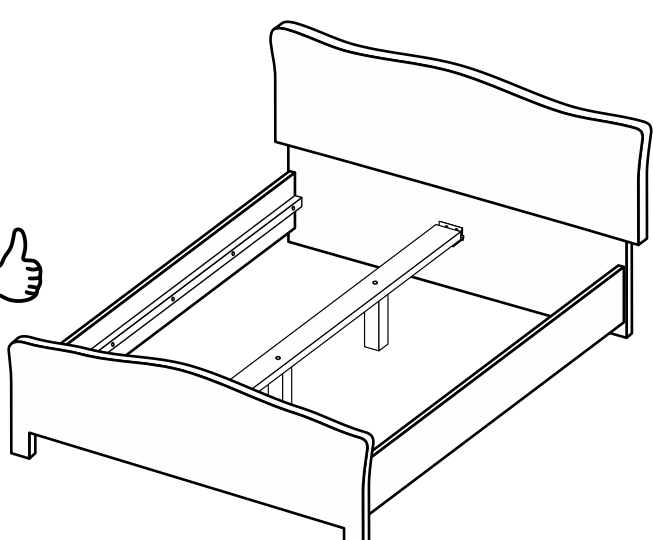
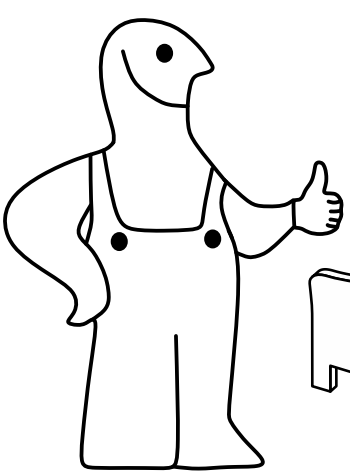

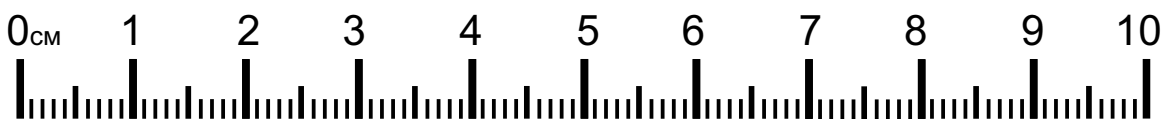
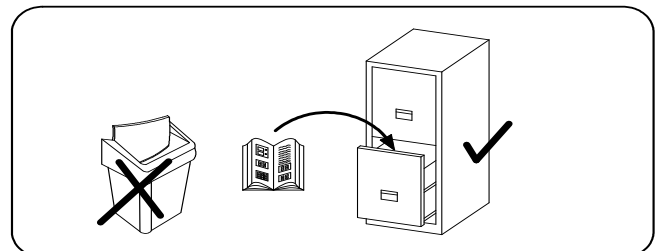
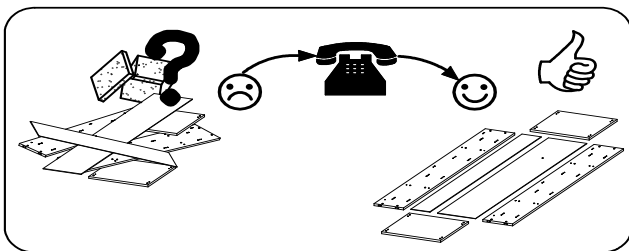
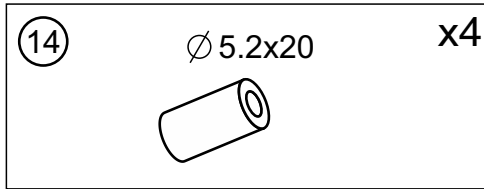
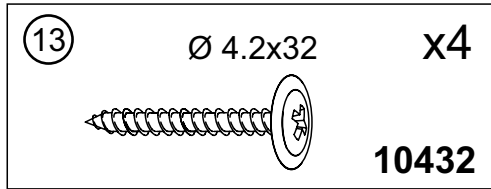
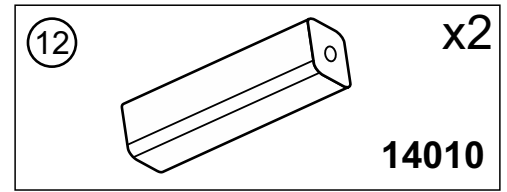
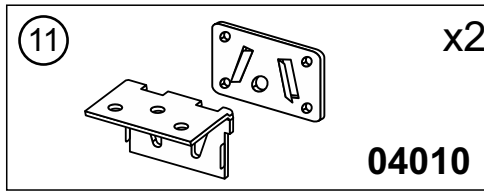
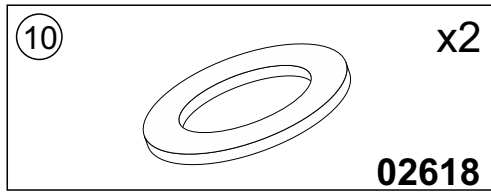
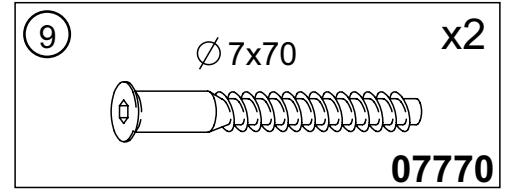
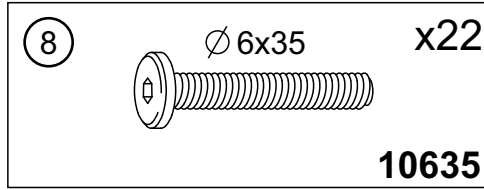
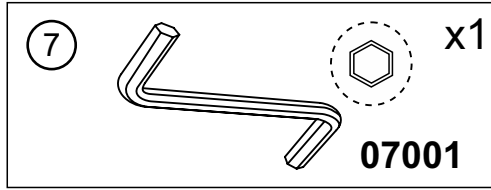
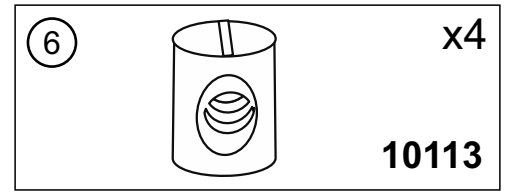
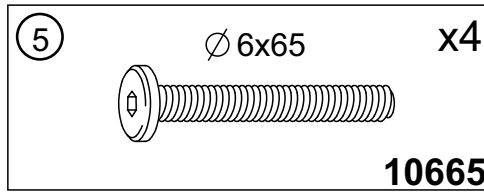
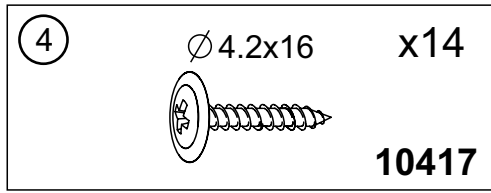
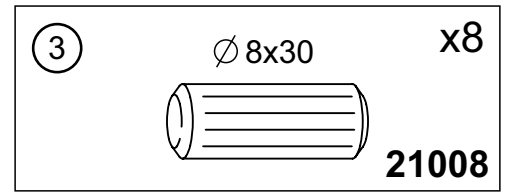
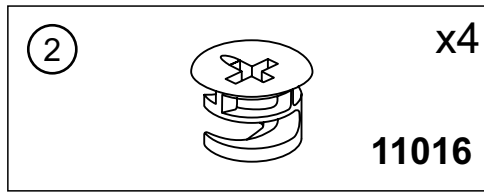
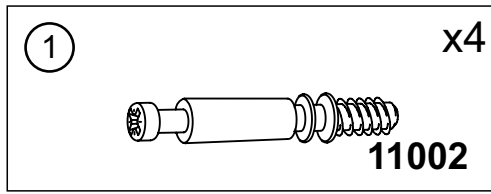

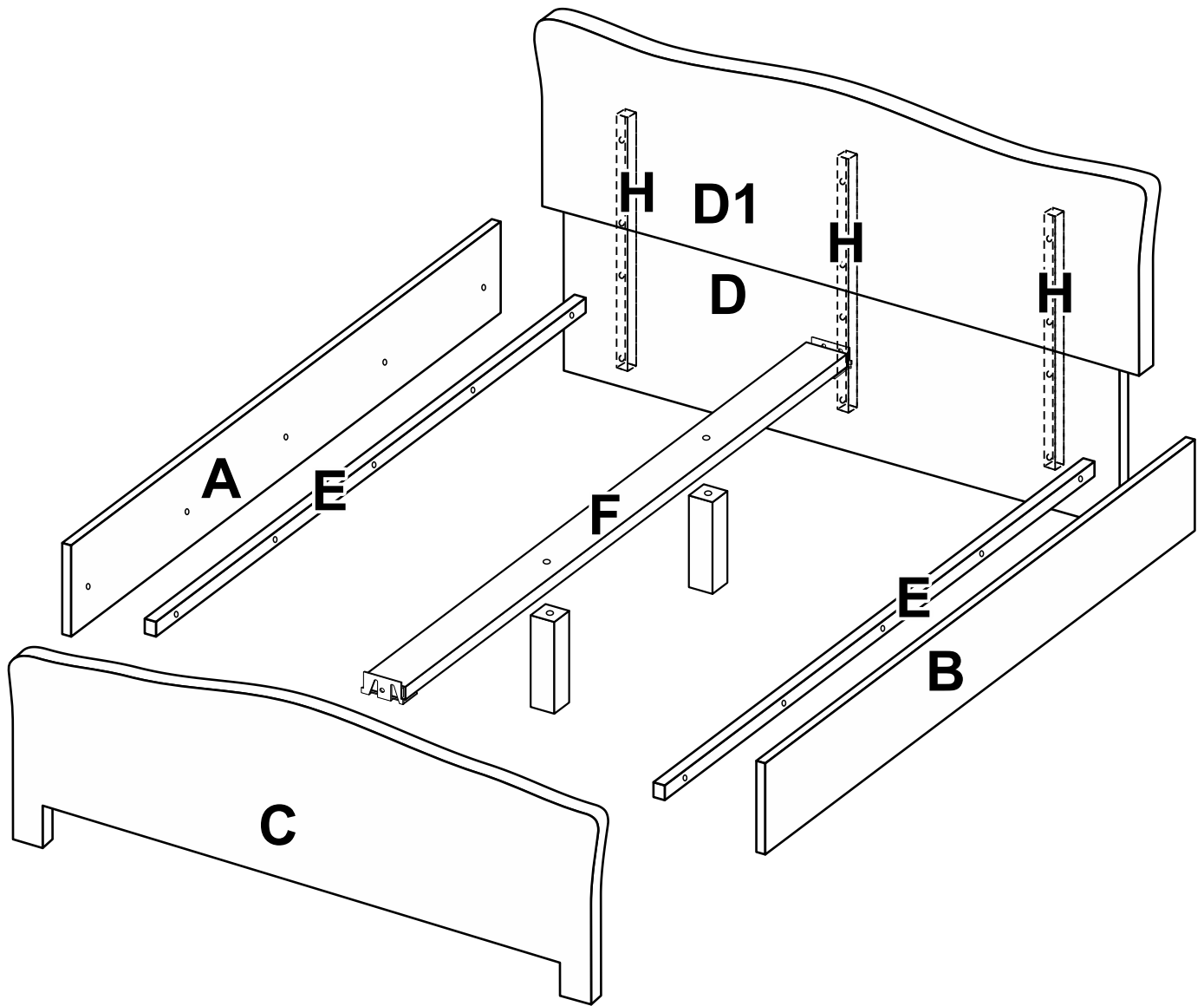

A	-	2008	x	250	x	18	-	x	1	2/3
B	-	2008	x	250	x	18	-	x	1	2/3
C	-	1920	x	600	x	18	-	x	1	2/3
D	-	1854	x	490	x	18	-	x	1	1/3
D1	-	1970	x	710	x	18	-	x	1	1/3
E	-	2008	x	35	x	25	-	x	2	1/3
F	-	2008	x	70	x	25	-	x	1	1/3
H	-	800	x	45	x	25	-	x	3	1/3

