

2-Sitzer ohne Armlehnen
 Fest oder Sitzauszug

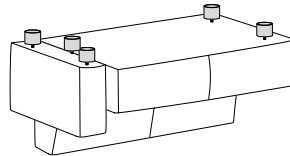

2-Sitzer Armlehne links/rechts
 Fest

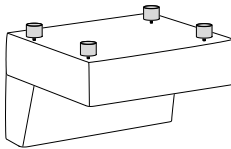

1,5-Sitzer ohne Armlehnen
 Fest oder Sitzauszug

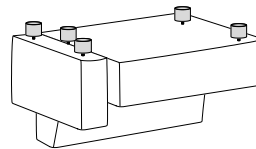

1,5-Sitzer Armlehne links/rechts
 Fest

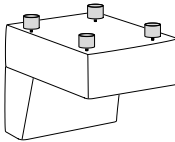

1-Sitzer ohne Armlehnen
 Fest oder Sitzauszug

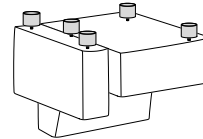

1-Sitzer Armlehne links/rechts
 Fest

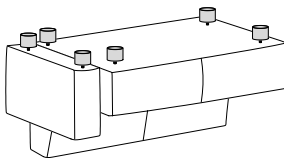

2-Sitzer Armlehne links/rechts
 Sitzauszug

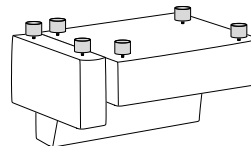

1,5-Sitzer Armlehne links/rechts
 Sitzauszug

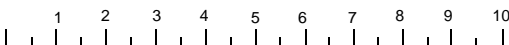

(A) Höhe 5 cm	(B) Höhe	(C) Höhe	(D) Höhe	(E) Höhe	(F) Höhe	Modellnummer 540, 2374
						Stand 07.12.2016
Gleiter						Revision 03
Werkseitig						Verfasser TKA

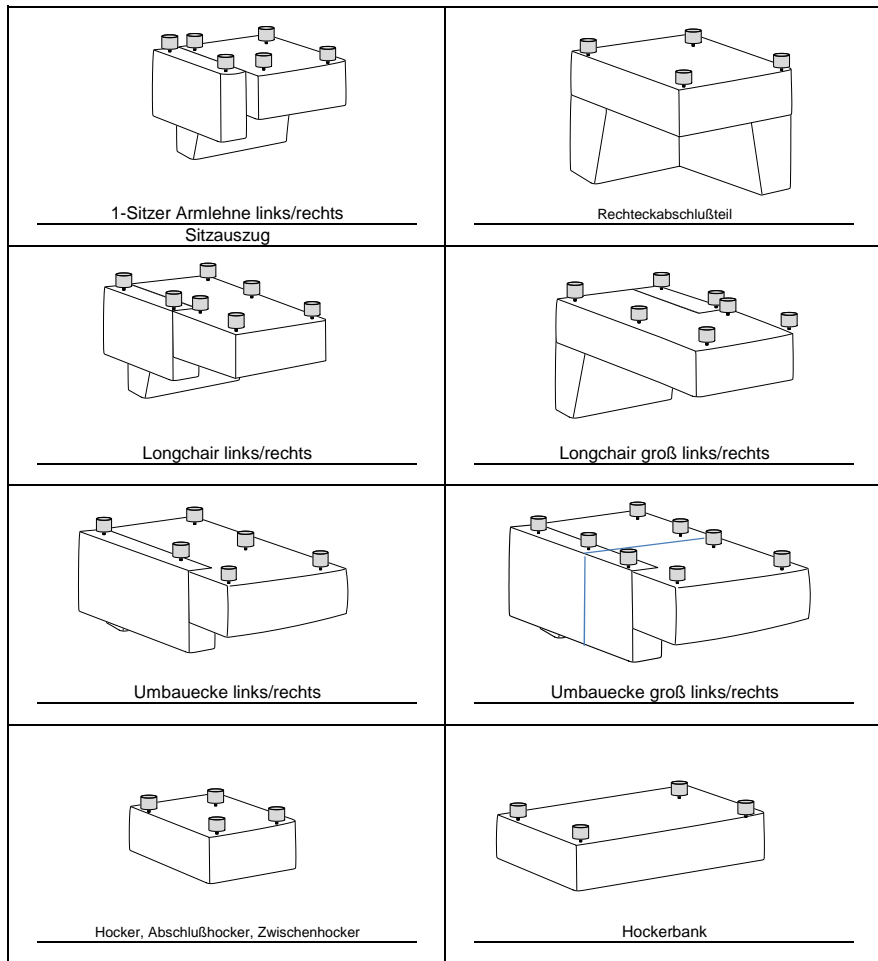

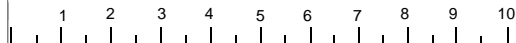

(A) Höhe 5 cm	(B) Höhe	(C) Höhe	(D) Höhe	(E) Höhe	(B)	Modellnummer 540, 2374
						Stand 07.12.2016
Gleiter						Revision 03
Werkseitig						Verfasser TKA

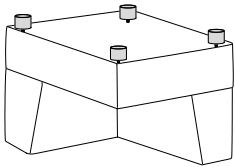

 <p style="text-align: center;">Spitzeckteil klein</p>	
 <p style="text-align: center;">Montage</p>	

(A) Höhe 5 cm	(B) Höhe	(C) Höhe	(D) Höhe	(E) Höhe	(F)	Modellnummer 540_2374
						Stand 07.12.2016
Gleiter						Revision 03
Werkseitig						Verfasser TKA

