

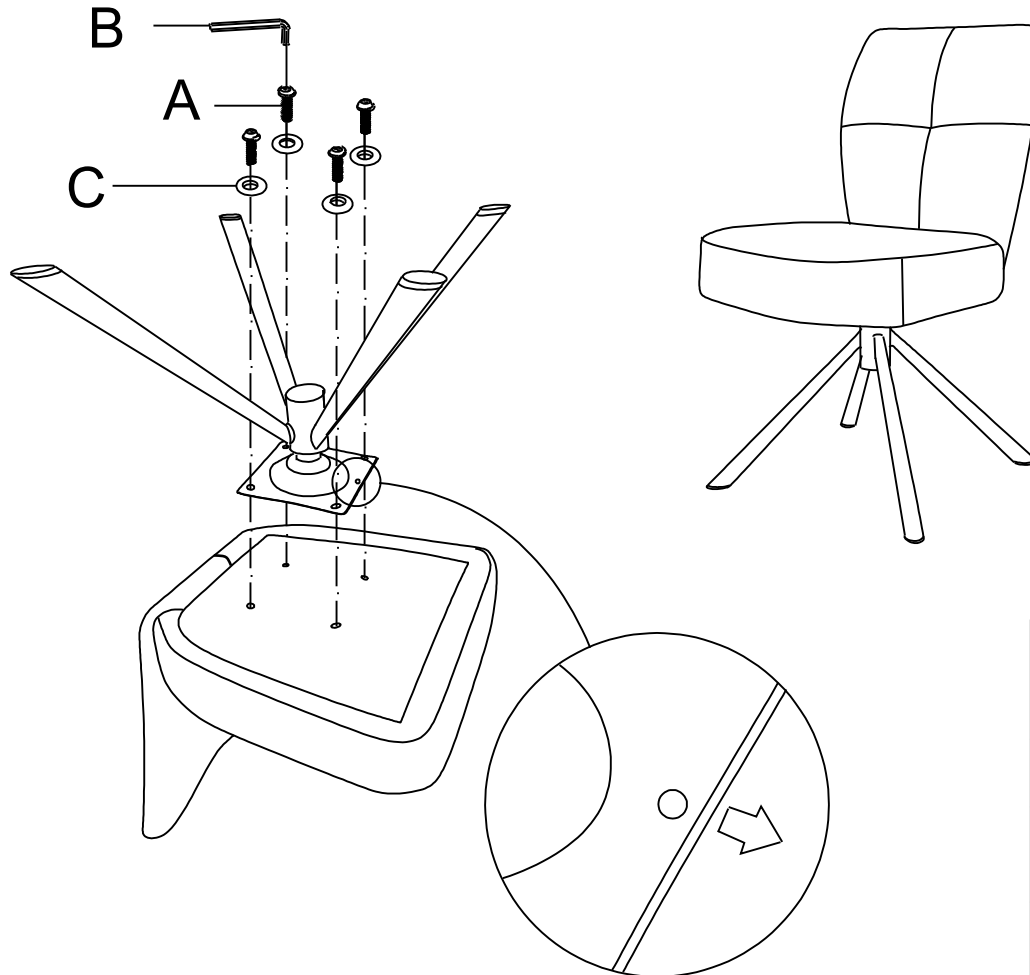







MCA furniture

KEA

STEP 1

STEP 2



		 1x
 1x	 M6*16 4x	 M5 1x
 4x		

D	Bitte überprüfen Sie in regelmäßigen Abständen den festen Sitz der Schrauben!	NL	Controleer op regelmatige afstanden of de schroeven goed vast zitten.
GB	Please check the screws for tightness at regular intervals!	SWE	Kontrollera med jämna mellanrum att skruvarna sitter fast ordentligt!
F	Veuillez contrôler régulièrement que les vis sont convenablement serrées !	SK	V pravidelných intervaloch kontrolujte pevné dotiahnutie skrutiek!
ES	¡Compruebe periódicamente que los tornillos estén bien apretados!	SL	Redno preverjajte, ali so vijaki trdno priviti!
IT	Controllare regolarmente che le viti siano ben strette!	NR	Redovito provjeravajte čvrsto nalijeganje vijaka!
PL	Należy regularnie sprawdzać dokręcenie śrub!		

