

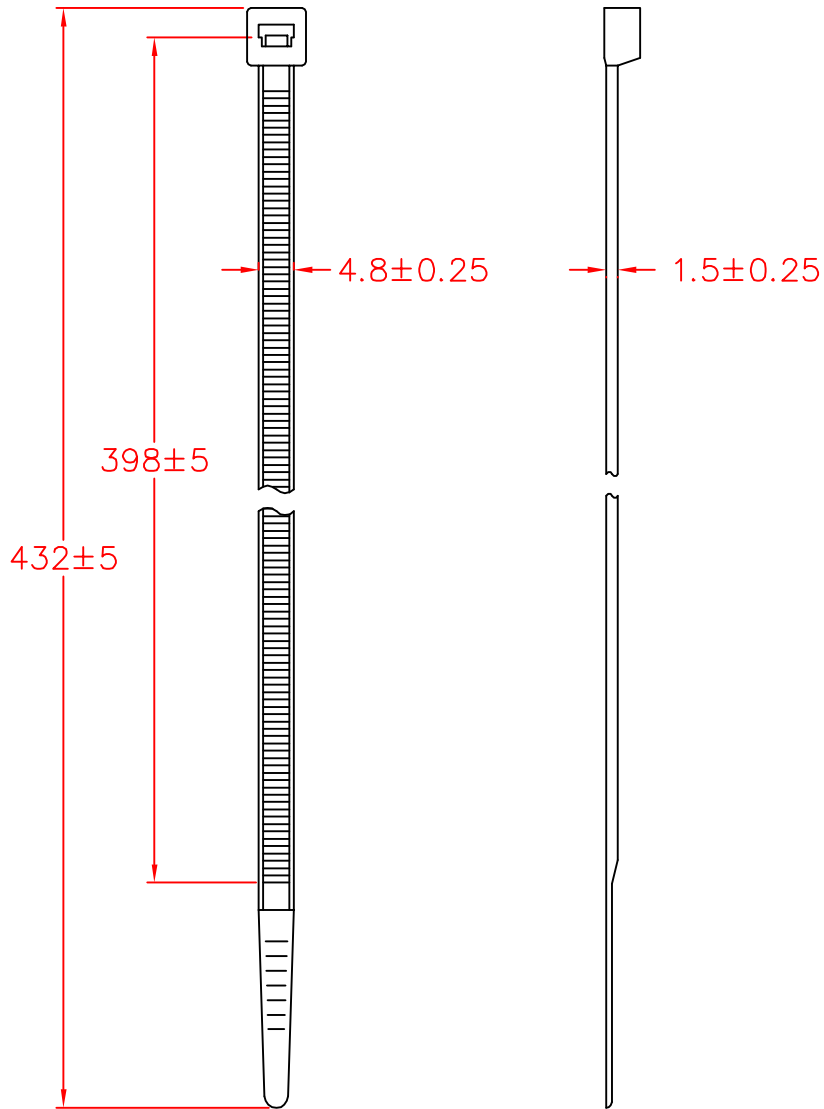

CV-432W



承認

 96.03.22
 邱平裕

審查

製圖

 96.03.22
 謝文通

設計

中文名		MATERIAL	UL 94V-2	ITEM NO.	CV-432W	
抗UV紮線帶			NYLON 66			
SCALE		FINISH		NAME	UV Resistant Nylon Cable Tie	
mm						
△	(' ')	TOLERANCE AS FIGURE		△	03-22-2007	REVISIONS K001
使用機種				DATE		R.NO.



凱士士企業股份有限公司

請勿實測圖面