

**D** Montageanleitung

**GB** Assembly instructions

**CZ** Montážní návod

**SK** Návod na montáž

**FR** Notice de montage

**IT** Istruzioni di montaggio

**HU** Szerelési útmutató

**RO** Instrucțiuni de montaj

**NL** Handleiding voor de montage

**PL** Instrukcja montażu

**TR** Montaj talimatı

**RU** Инструкция по монтажу

# SKIDI 3

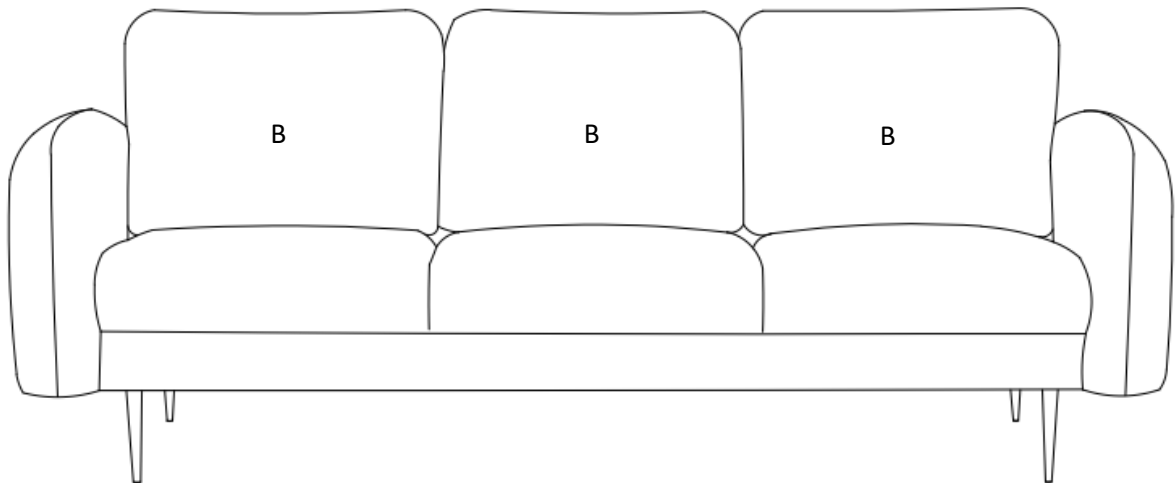

A

4x



B

3x



C

4x

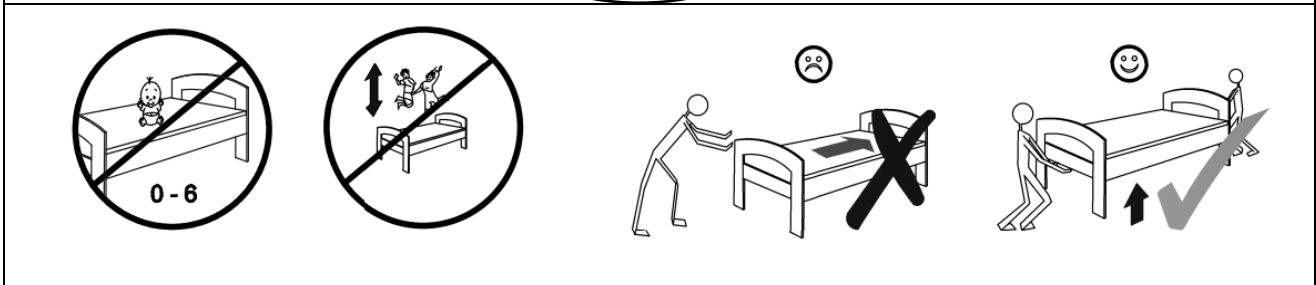
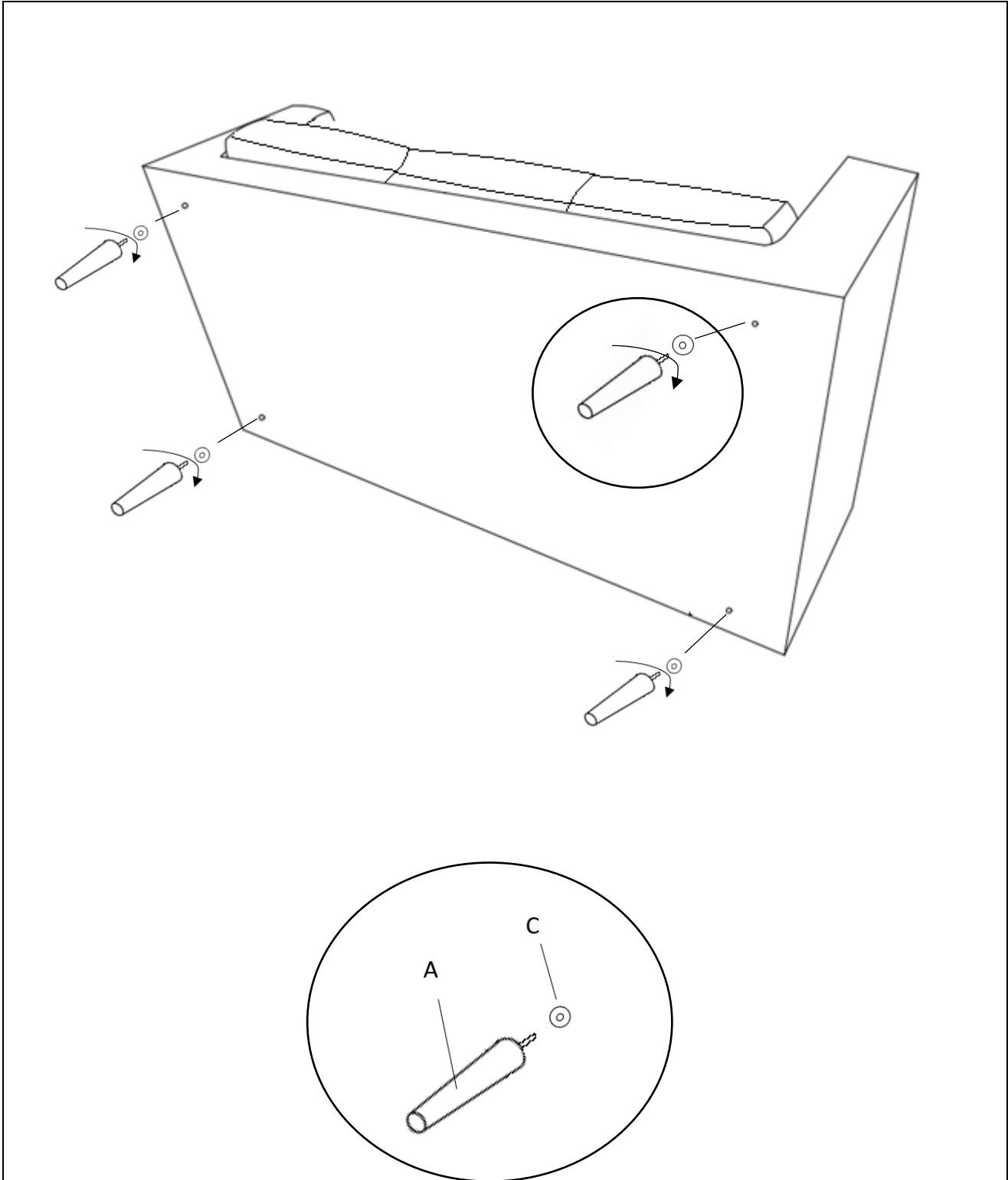

**Service • Assistenza • Dienstverlening • Serwis  
Servis • Szerviz • Сервисная служба**

Name • Naam • Nazwa • İsim • Название

**SKIDI**

Nr. • No. • Номер

Тур • Туре • Тір • Тип

**3**

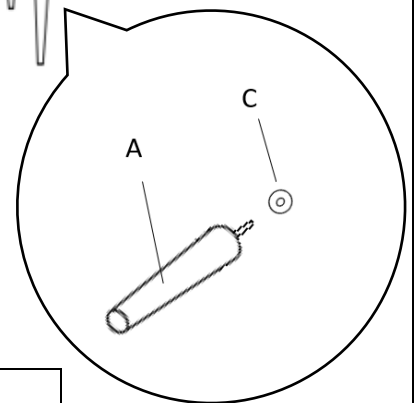
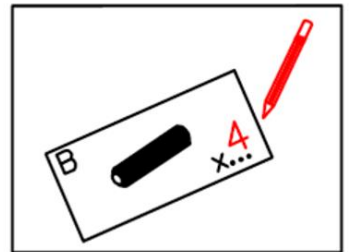
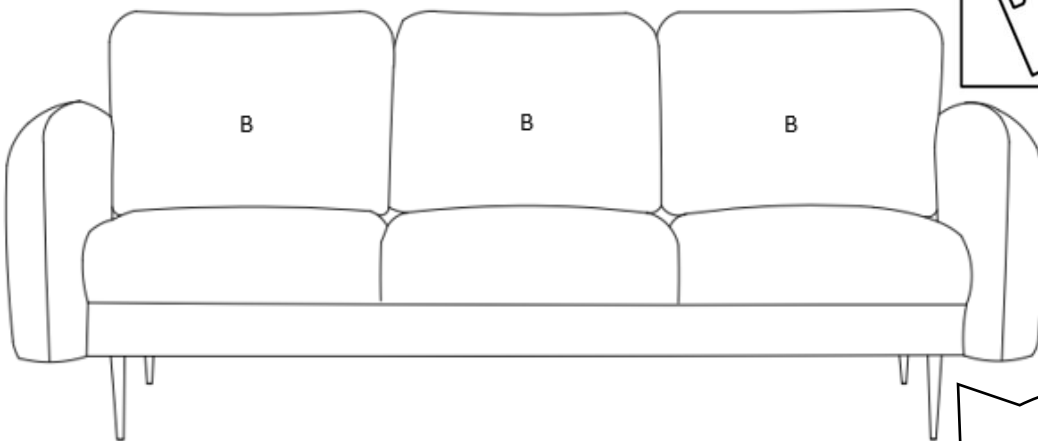
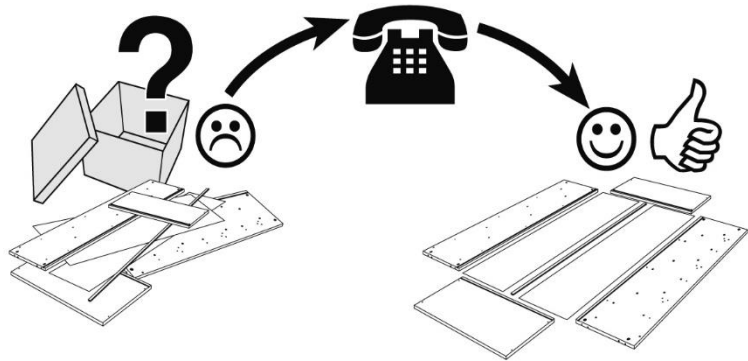
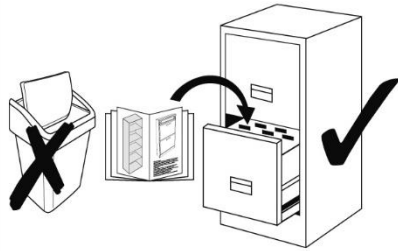

A

.....

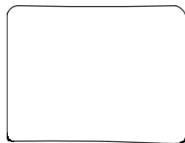

B

.....



C

.....