

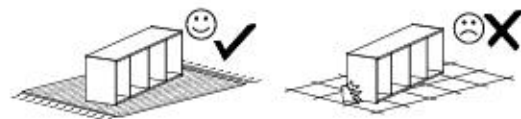

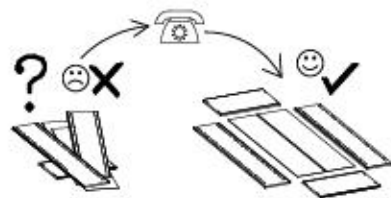

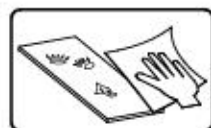

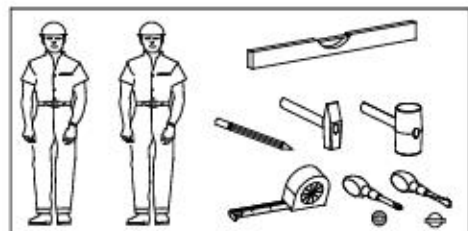
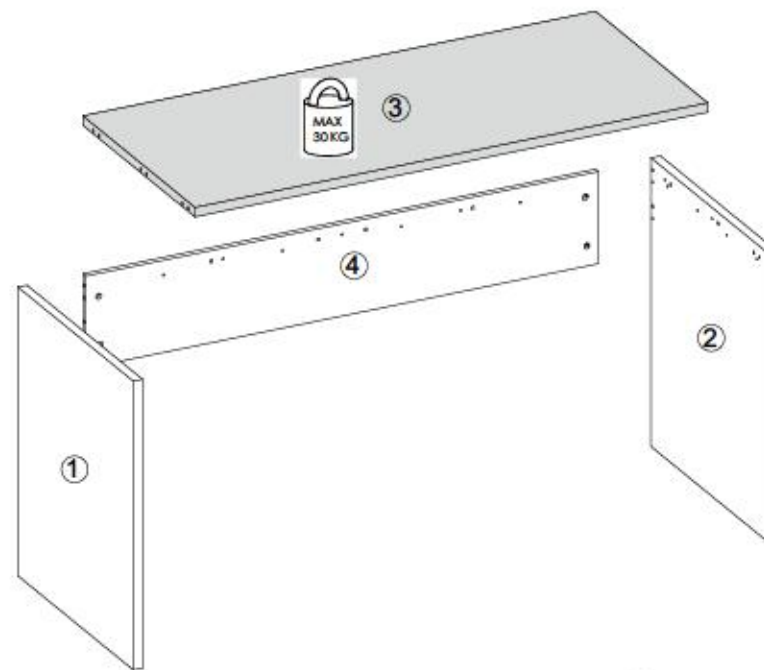

- Ⓛ Montageanleitung
- Ⓝ Handleiding voor de montage
- Ⓜ Montaj talimat
- Ⓧ Notice de montage
- Ⓢ Montážní návod
- Ⓟ Szerelési útmutató
- Ⓠ Assembly Instructions
- Ⓡ Instrukcja montażu
- Ⓡ Инструкции по монтажу
- Ⓡ Istruzioni di montaggio
- Ⓡ Návod na montáž
- Ⓡ Instrucțiuni de montaj
- Ⓡ Instrucciones de montaje
- Ⓡ Montaj Talimat



nr	L[mm]	B[mm]	T[mm]	Menge	Colt
1	762	622	25	1	1/1
2	762	622	25	1	1/1
3	1380	604	25	1	1/1
4	1380	280	16	1	1/1



W1  x3	B1  ø8x35 x16	I7a  x4	I7c  x9
K1  x13	K10  x13	P4  x4	F4  x12



I

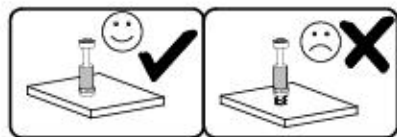
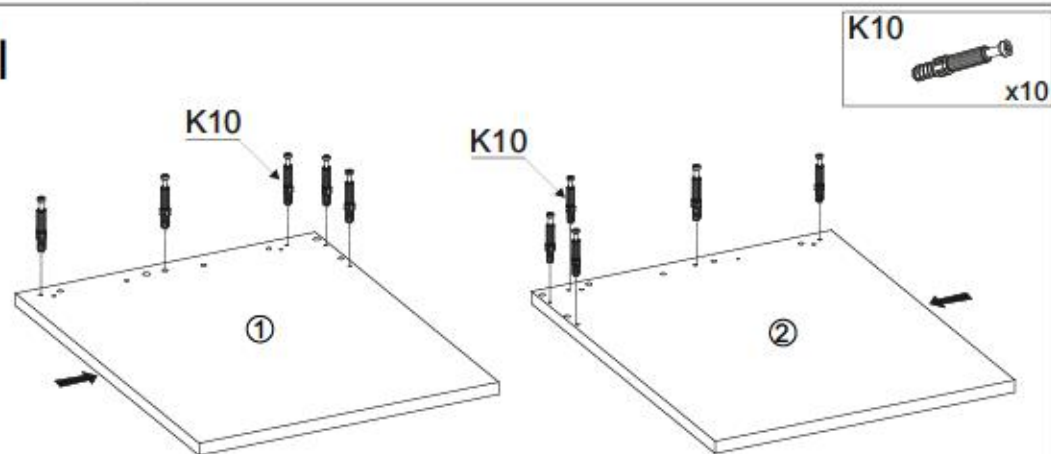

II

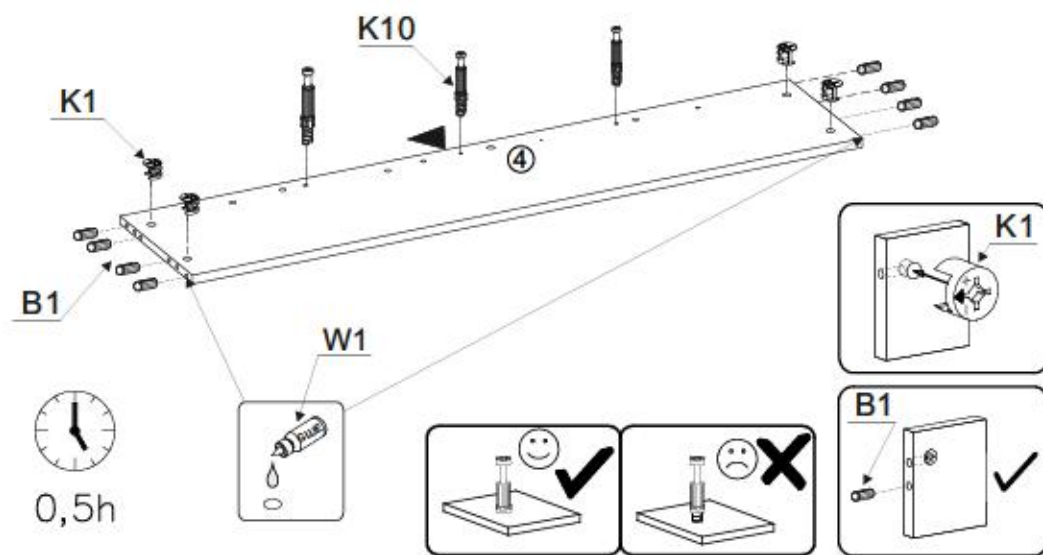
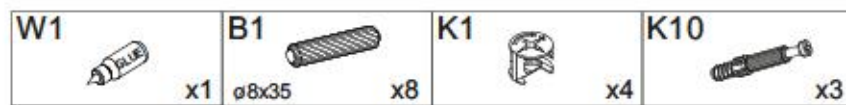

III

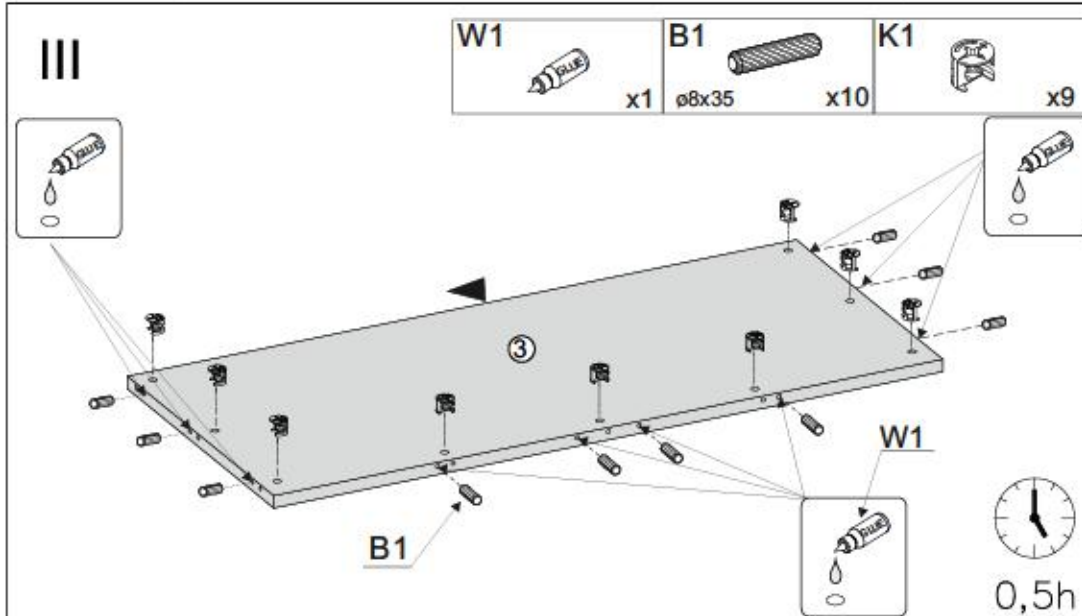

IV

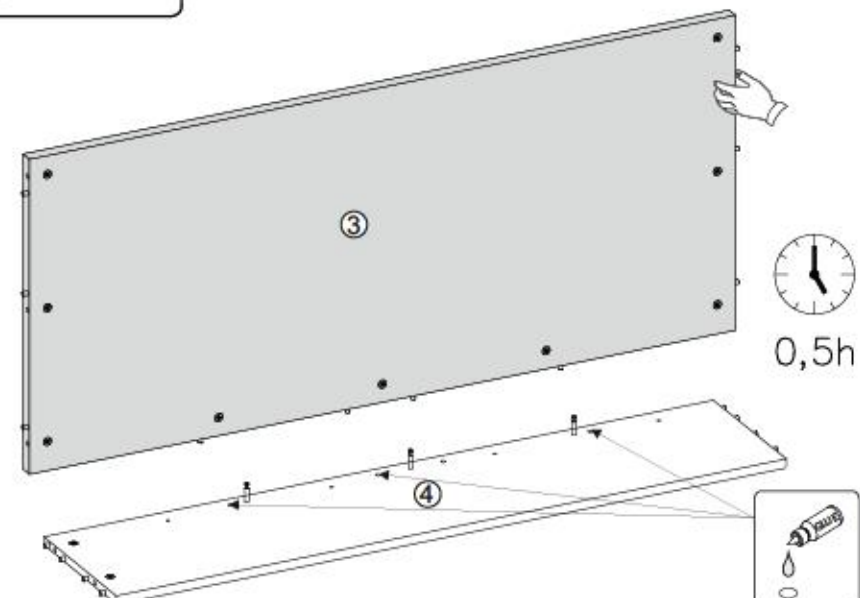
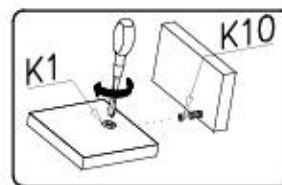



V

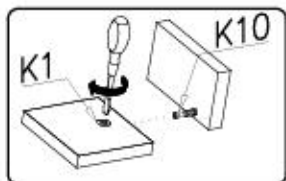

0,5h

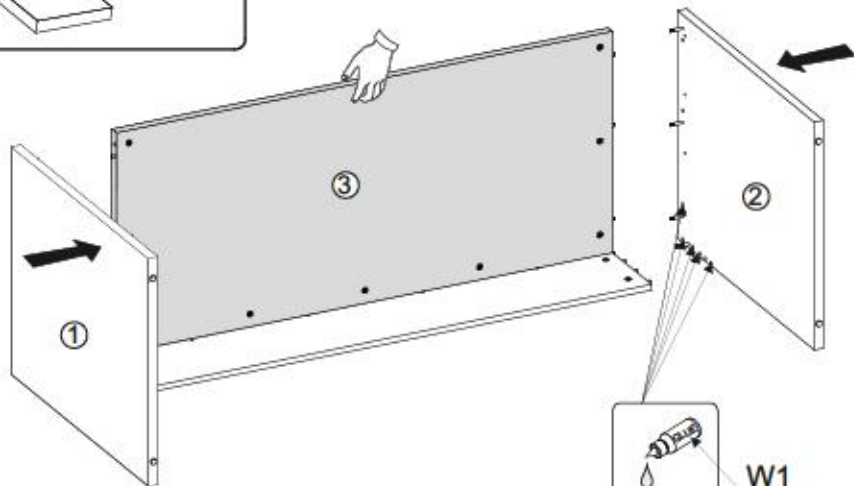

VI

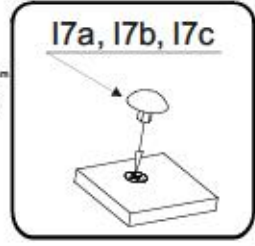
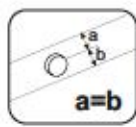
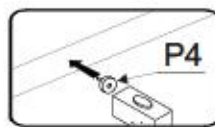
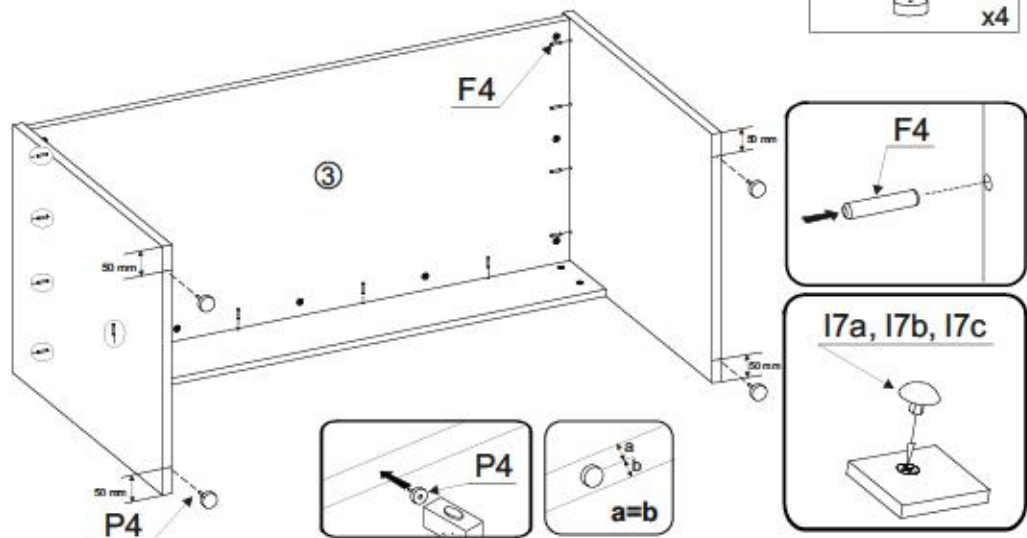
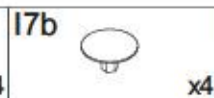
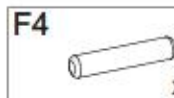

Name • Nom • Nome • Naam • Nazwa • Jméno  
• Νόζον • Név • Denumire • Isim • Имя

Nr • No • N° • Номер • Č • Sz

Typ • Type • Tip • Трпс • Трп • Tun

CITY / GIRON

--

06

**D** **Linea Distributrice: Be Beschäftigte**  
Sollte Ihnen ein Beschädigtes Teil, können Sie diese Servicekarte direkt an die untenstehende Adresse mailen. Wir können allerdings nur Beschädigte auf diesem Wege versenden. Sollten Sie eine andere Beschwerde an Ihren Möbelstück haben, so wenden sie sich bitte direkt an Ihr Möbelhaus.

**GB** Our direct order service for filling  
if a filling part is missing, you can e-mail this service card directly to the address below. However, we can only send filling parts in this way if you have any claims for complete covering your item of furniture, please contact your furniture store directly.

**CZ** Náš přímý službu pro leštění  
Chytl-li vám nějaký díl z kování, můžete tuto servisní kartu odeslat e-mailem přímo na níže uvedenou adresu. Auto cestou však můžeme poslat jen díly kování. Pokud byste měli nějaký jiný problém, obraťte se na svého prodejce nábytku.

**F** Bien étaler la notice de montage  
Si vous manquez une teneur, veuillez envoyer directement la présente carte ainsi qu'à l'adresse e-mail il indiquée ci-dessous. Cependant, nous ne pouvons uniquement d'envoyer des teneurs. Pour tout autre type de réclamation concernant votre meuble, veuillez contacter directement votre magasin d'ameublement.

**I** Il nostro servizio diretto per il ordine della lavorazione  
Qualora Vi dovesse mancare un pezzo di fissaggio, allora Vi preghiamo di inviare questa carta di servizio immediatamente all'indirizzo sottostante. Possiamo inviare i pezzi di fissaggio solamente per mezzo di questo procedimento. Qualora dovete avere qualche altra reclamazione in merito al mobile, allora Vi preghiamo di rivolgerVi direttamente al Vostro Negozio di mobili.

**BG** Наш директен сервис за поръчки  
Ако ви липне част от монтажната част, моля да ни изпратите тази картичка директно на адреса, който е посочен по-долу. Можем да ви изпратим само частите за монтаж. Ако имате друга жалба относно мебелта, моля да се свържете директно с вашия магазин за мебели.

**NL** Onze directie voor losse onderdelen  
Wanneer er een onderdeel ontbreekt, kunt u deze servicekaart direct aan onze afdeling e-mailen. Wij kunnen in deze weg echter alleen bestelgedeelten verzenden. Mocht u een ander probleem met uw meubel hebben, is contact op te nemen met uw meubeldealer.

**PL** Nasz bezpośredni serwis części montażowych  
Jeśli w trakcie montażu brakuje części do montażu, prosimy o przesłanie nam niniejszej karty serwisowej na niżej podany adres e-mailowy. Wzrostnie możemy przesłać jedynie części do montażu. W przypadku innych reklamacji dotyczących mebla, prosimy o kontakt z miejscowym sprzedawcą mebli.

**HR** Servis za otkove  
U slučaju da nedostaje neki od dijelova potrebno vam da nas dođe u posjedovanje mail adresom podjelom ovisno o zemlji. Na ovaj način mogu se dostaviti samo otkovi. U slučaju da imate dodatne prigovore vezane uz kovanje namještaja molimo vas da se obratite bravnom trgovini namještaja gdje je ili kupili.

**HU** Direktrendelési kártya vezetékek esetén  
Ha hiányzik egy vezeték, ezt a kártyát közvetlenül elküldhet az alábbi címre. Azonban csak a vezetékek tudunk így küldeni. Amennyiben másféle problémát szeretne feljelenteni, kérjük, forduljon közvetlenül a boltiértelhez.

**SK** Náš priamy servis pre chýbajúce kovanie  
Ak by Vám chýbala nejaká časť kování, môžete poslať túto servisnú kartu priamo e-mailom na nižšie uvedenú adresu. Cieľom kování vieme poslať iba týmto spôsobom. Ak by ste mali inú reklamáciu ohľadom vášho nábytku, obraťte sa prosím na váš predajcu nábytku.

**SLO** Náš direktno uslužbeni storitev za otkove  
Vse manjkajoče delce kovanja lahko v zemljevo kartečko pošljete po e-pošti direktno na spodnji naslov. Po tej poti vam lahko pošljemo samo otkove. Če želite reklamirati kakšen drug del pohištva, se obrnite neposredno na vašo trgovino pohištva.

**RO** Serviciul nostru direct pentru fierărie  
În caz în care vă lipsește o piesă de fierărie, puteți trimite această card de servicii direct la adresa de mai jos. Noi nu putem expedia piese de fierărie decât pe această cale. Dacă aveți o altă reclamație referitoare la piese de mobilier, atunci vă rugăm să vă adresați direct la magazinul dvs. de mobilier.

**RUS** Наш прямой сервис для крепежа  
Если Вам не хватает какой-либо детали крепежа, пожалуйста, отправить эту карточку напрямую по адресу, который указан ниже. Мы можем доставить только детали крепежа. Если у Вас есть другая претензия по поводу мебели, пожалуйста, обратитесь непосредственно к продавцу мебели.

**S** Vår direktservice för beställningar  
Om du saknar en beställning kan du skicka detta servicekort direkt till e-postadressen som anges nedan. Tänk på att detta är den enda möjligheten att skicka beställningar till oss. Om du vill reklamera din möbel av annan anledning rekommenderar vi kontakt med möbelsäljaren direkt.

**ES** Nuestro servicio directo para accesorios  
Si le falta al algún accesorio, puede enviar esta tarjeta de servicio directamente a la siguiente dirección. No obstante, por este método solo podemos enviar accesorios. Si tiene alguna otra objeción sobre su mueble, consulte directamente con su mueblería.

**TR** Doğrudan hizmet için başvuru kartı  
Bir donanım parçasının veya aksesuarın eksikliği durumunda doğrudan hizmet için aşağıdaki adresi kullanabilirsiniz. Ancak, bu yöntemle sadece aksesuarları gönderebiliriz. Mobilya ile ilgili başka bir şikayetiniz varsa lütfen doğrudan mobilya satıcınıza başvurun.

nr	L [mm]	B [mm]	T [mm]	Merçe	Cut
1	762	622	25	1	1/1
2	762	622	25	1	1/1
3	1380	604	25	1	1/1
4	1380	175	16	1	1/1

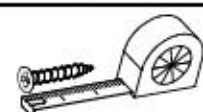
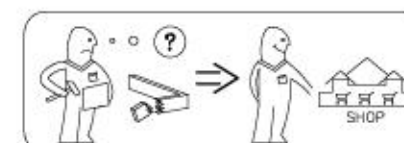
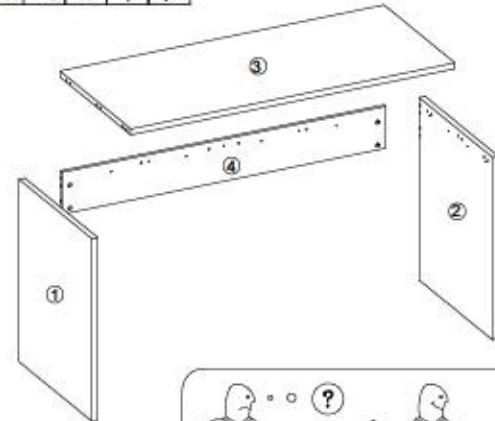

B1 ø8x35 x...	I7a x...	W1 x...
I7c x...	K1 x...	K10 x...
P4 x...	F4 x...	

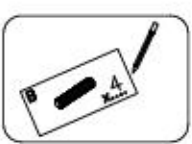

+49 5233 95 290 10

service@mv-stelhelm.de





- ⓓ **Montageanleitung**
- ⓃⓁ **Handleiding voor de montage**
- ⓉⓇ **Montaj talimatı**
- ⓕ **Notica de montage**
- ⒸⓏ **Montážní návod**
- ⓗⓤ **Szerelési útmutató**
- ⓖⓔ **Assembly Instructions**
- Ⓟ **Instrukcja montażu**
- Ⓡⓤ **Инструкция по монтажу**
- Ⓡⓐ **Istruzioni di montaggio**
- ⓈⓀ **Návod na montáž**
- Ⓡⓞ **Instrucțiunile de montaj**
- ⓔⓢ **Instrucciones de montaje**
- ⓉⓇ **Montaj Talimatı**

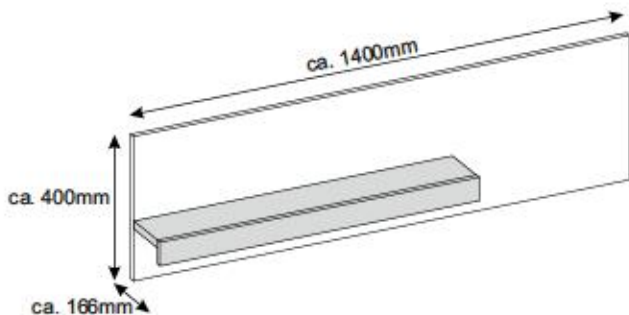

n°	L[mm]	B[mm]	T[mm]	Versione	Coli
1	1400	400	16	1	1/1
2	900	134	16	1	1/1
3	902	65	16	1	1/1

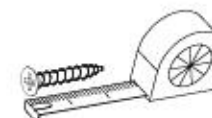
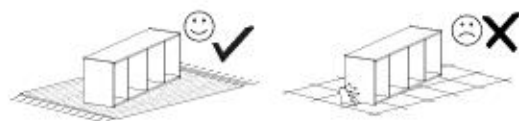
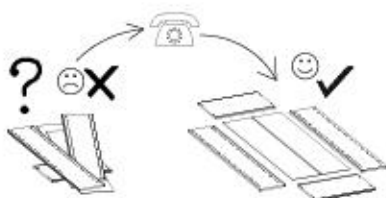
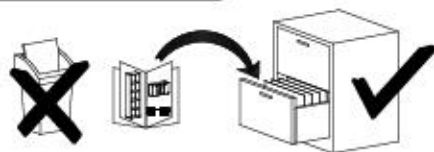
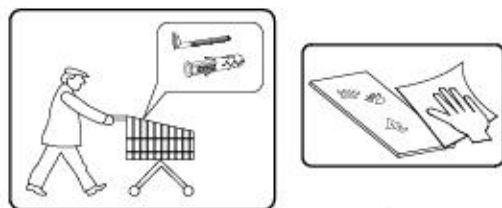
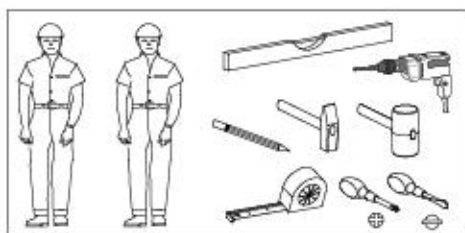
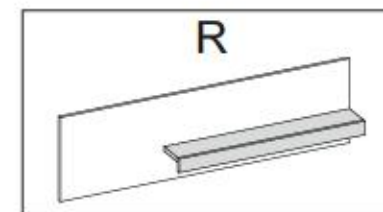
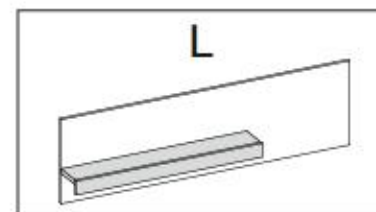
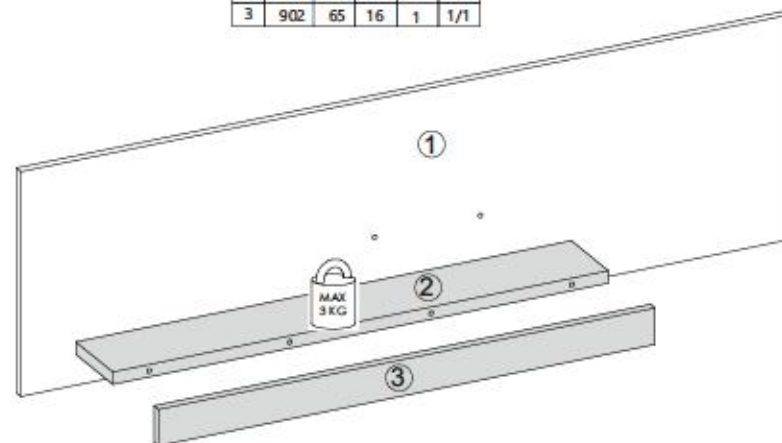

A1 ø7x50 x4	W2 x1	G52 5x11 x6	P10 x3	I7 x4
K1 x4	K10 x4			

3/8

CITY / GIRON 73



I

G52

5x11



x6

P10



x3

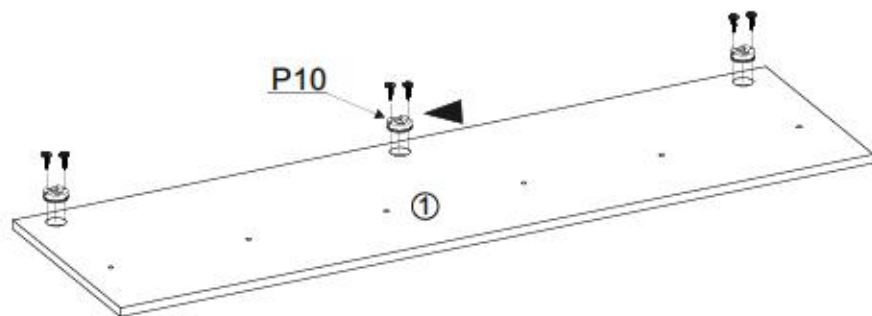

P10

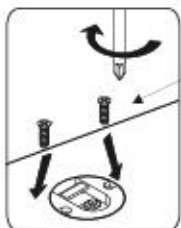
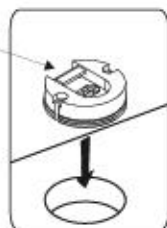

G52



II

K1



x4

K10



x4

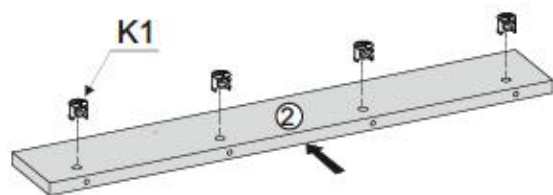

K10

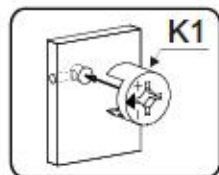
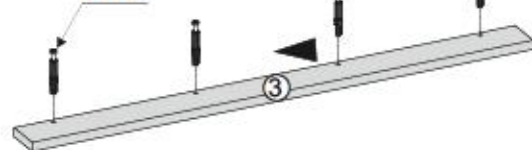

4/8

CITY / GIRON 73



III

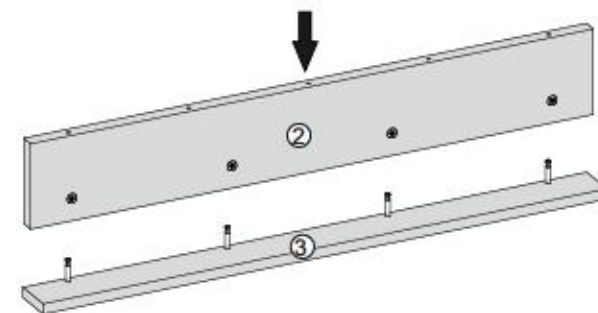
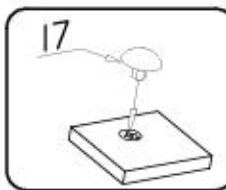
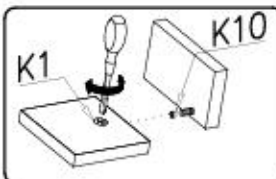

I7



x4

IV

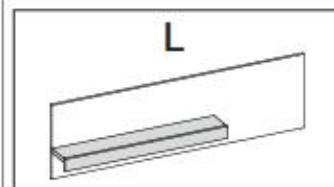

!

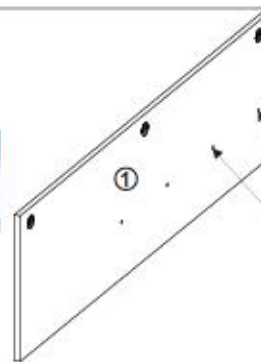

A1

ø7x50

x4

W2



x1

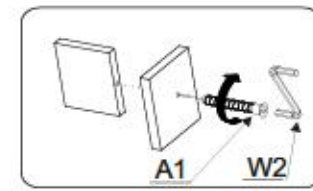
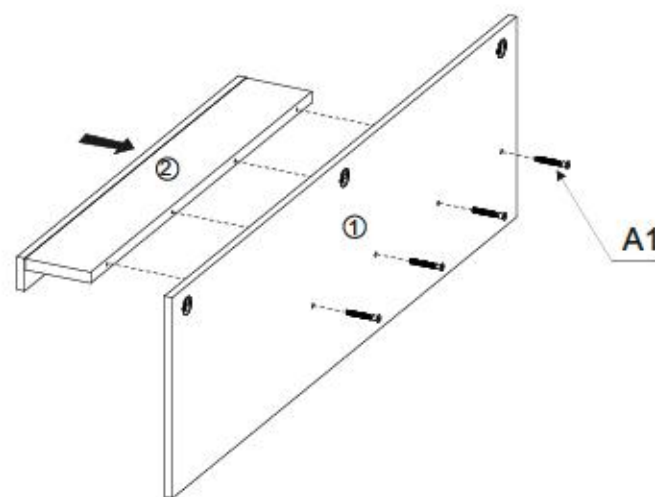
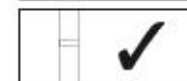
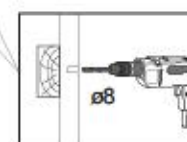

A1

W2

5/8

CITY / GIRON 73



V

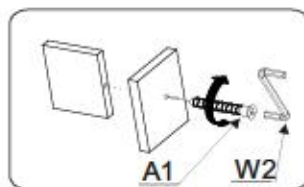
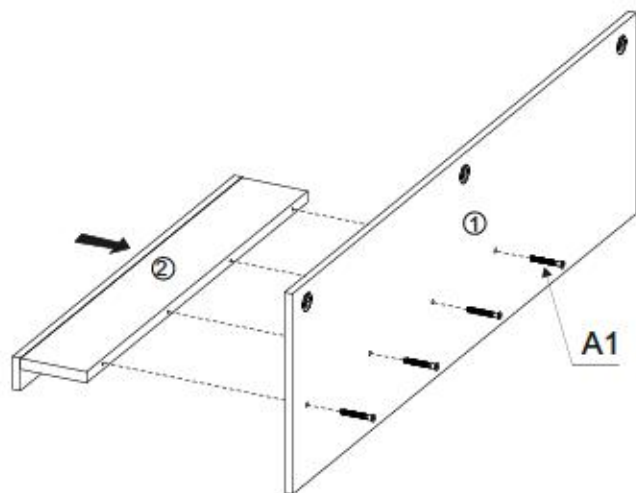
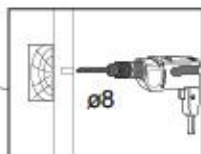
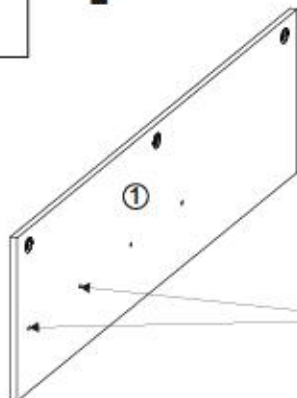
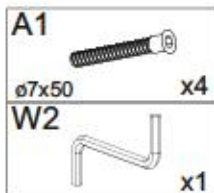
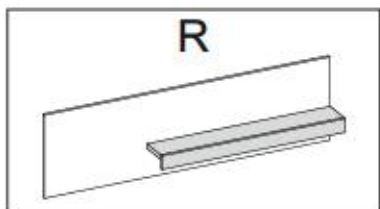

6/8

CITY / GIRON 73



VI

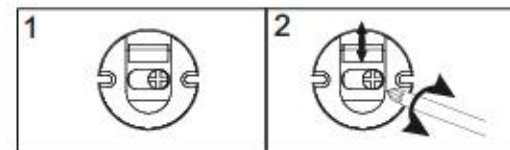
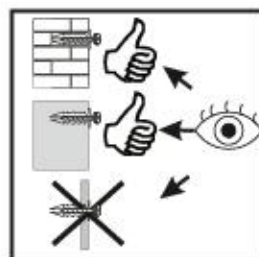
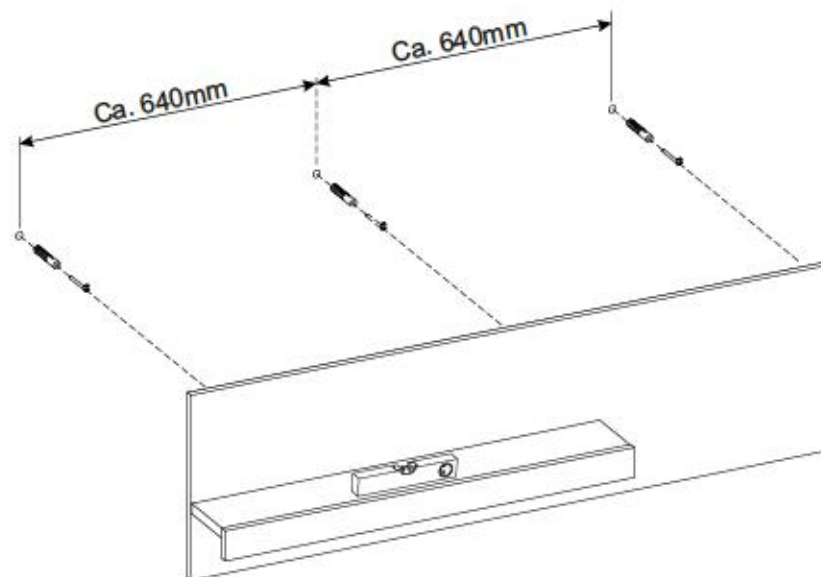
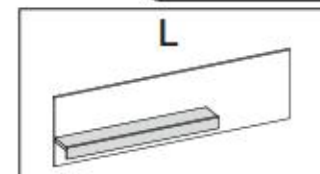
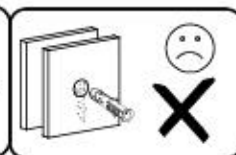
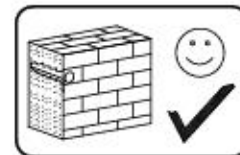



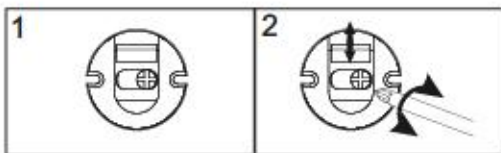
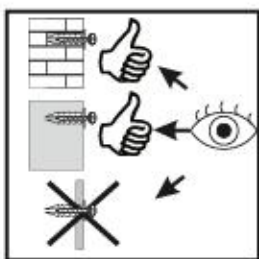
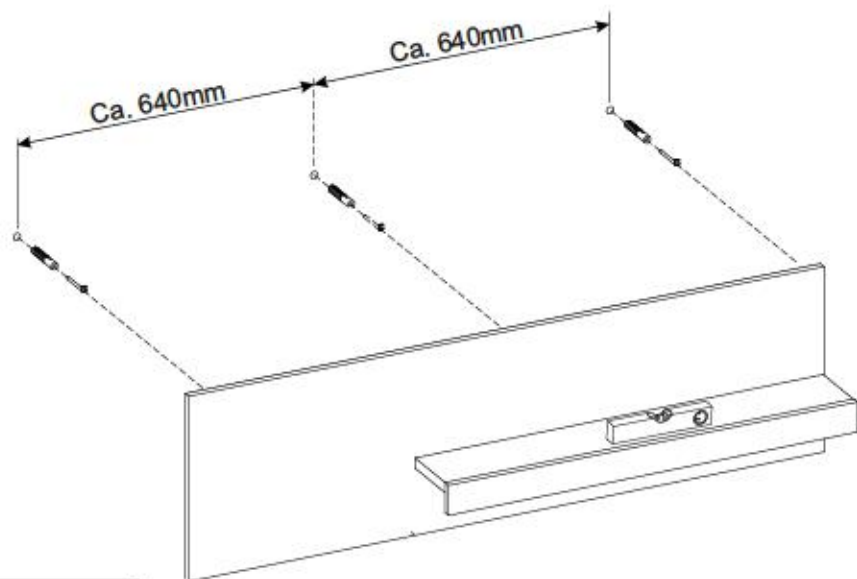
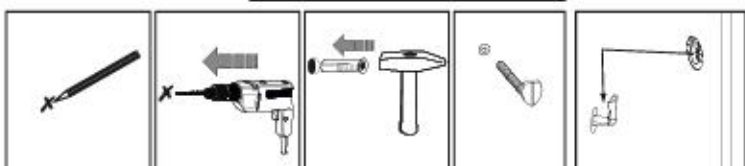
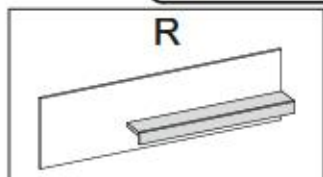
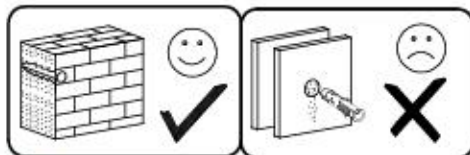

## VII

Name • Nom • Nome • Naam • Nazwa • Jméno  
• Názov • Név • Denumire • Isim • Имя

Nr • No • N° • Номер • Č • Sz

Typ • Type • Tip • Típus • Тipo • Tun

CITY / GIRON

--

73

**D** Utolsó Díszítés/Építés Utasítások  
Sólym Írni az Beszélgetés/Építés, Irtóvén Széle Széle/Építés  
direkt an die unterstehende Adresse machen. Wir können allerdings  
nur Bestelldatien auf diesem Wege verschicken. Sollten Sie eine  
andere Besetzung an Ihren Wohnort haben, so wenden Sie  
sich bitte direkt an Ihr Möbelhaus.

**GB** Our direct order service for fitting  
If a fitting part is missing, you can e-mail this service card directly  
to the address below. However, we can only send fitting parts in  
this way. If you have any other issues for completion concerning  
your item of furniture, please contact your furniture store directly.

**CZ** Naše přímé služby pro kování  
Chybí-li vám nějaký díl z kování, můžete tuto službu rovnou odeslat  
e-mailem přímo na níže uvedenou adresu. Touto cestou však  
můžeme odeslat jen díly kování. Pokud byste měli nějaký jiný problém  
s výrobkem, obraťte se přímo na svého prodejce nábytku.

**F** Bien étudier la notice de montage  
Si vous remarque une erreur, veuillez envoyer directement la présente  
carte service l'adresse e-mail indiquée ci-dessous. Cependant, ceci  
nous permet uniquement d'envoyer des s. Pour tout autre type  
de réclamation concernant votre meuble, veuillez contacter  
directement votre magasin d'ameublement.

**I** Il nostro servizio diretto per l'ordine della lavorazione  
Qualora Vi dovesse mancare un pezzo di fissaggio, allora Vi  
preghiamo di inviare questa carta di servizio immediatamente  
all'indirizzo sottostante. Possiamo inviare i pezzi di fissaggio  
solamente per mezzo di questo procedimento. Qualora dovesse  
avere qualche altro problema in merito al mobile, allora Vi  
preghiamo di rivolgerVi direttamente al Vostro Negozio di mobili.

**BG** Нашата директна услуга за облич  
Ако липовата част от комплект, потърсете настоящата  
сервисна карта и я изпратете на е-мил адреса, посочен  
по-долу. Тя може да бъде използвана за доставяне само на липсващи  
елементи от облич. Ако установите други дефекти по  
мебелта, се съветваме да се обвързате със мебелната  
експлоатация, от който сте закупили стоката.

**NL** Onze directie voor losse onderdelen  
Wanneer er een onderdeel ontbreekt, kunt u deze aanvragen  
direct aan onderstaand e-mailadres sturen. Wij kunnen langzamer  
weg echter alleen bestelgegevens versturen. Mocht u een ander  
probleem met een meubel hebben, verzoeak wij u contact op te  
nemen met uw meubeldealer.

**PL** Nasz bezpośredni serwis części montażowych  
Jeżeli brakuje części koniecznych do montażu, prosimy o przesłanie  
ni jej bezpośrednio na poniższy adres e-mailowy.  
W ten sposób możemy przesłać jedynie brakujące części.  
W przypadku innych reklamacji dotyczących mebla, prosimy o kontakt  
z naszym meblowcem, w którym został dokonany zakup.

**HR** Servis za otkove  
U slučaju da nedostaje neki od dijelova mobilno vas da na dalje  
poveštaviti mail adresom poljudnje ovog servisa. Na ovaj način  
možu se dostaviti samo otkovi. U slučaju da imate dodatne prigovore  
vezane uz lošad namještaja molimo vas da se obratite bravno  
trgovini namještaja gdje je isti kupljen.

**HU** Direktrendelgetésű variabélis szállítás  
Ha hiányzik egy variabélis, ezt a kórhelyt közvetlenül elküldhet az  
alább található címre. Azonban csak variabélisokat tudunk így  
küldeni. Amennyiben másféle reklamációt kíván beküldeni, ké-  
rjük, forduljon közvetlenül a boltvezetőhöz.

**SK** Naše přímé služby pro částí kování  
Ak by Vám chýbala nejaká časť kování, môžete poslať  
túto službu rovnou e-mailom na nižšie uvedenú  
adresu. Cieľou kování sme poslať iba kování kování.  
Ak by ste mali iný problém s výrobkom, obráťte sa  
priamo na Vašu predajcu nábytku.

**SLO** Naše direktno uslugi za oblič za otkove  
Da vam manjka kakikoli delov, lahko to nameno listico pošljete  
po e-pošti direktno na spodnji naslov. Po to je pošiljati lahko  
samo samo otkove. Če imate kakikoli dodatni drug del  
površila, se obrnite neposredno na vašo trgovino pohištva.

**RO** Serviciu în mod direct pentru furnizarea  
În cazul în care vă lipsește o piesă de înlocuire, puteți să  
direct acest card de serviu prin e-mail la adresa de mai jos. Noi  
nu putem expedia piesa de înlocuire decât pe această cale.  
De altfel, o altă reclamație referitoare la piesa de mobilă se  
afectă să rugăm să vă adresați direct la magazinul dvs. de mobilă.

**RUS** Наша прямой сервис для поставки фурнитуры  
Если окажется, что Вам не хватает той или иной комплектной  
фурнитуры, Вы можете отправить эту форму непосредственно на  
непосредственно на нижеприведенный адрес электронной  
почты. Однако, такие образцы мы можем пересылать лишь  
фурнитуры. Если же у Вас возникнут иные претензии относительно  
какой-либо мебели, пожалуйста, обращайтесь  
непосредственно в магазин, осуществляющий продажу.

**S** Vår direkte tjena för beställningar  
Om du saknar en beställning, kan du skicka detta servicekort direkt  
till e-postadressen som anges nedan. Tillåt oss dock bara skicka  
delar som saknas till beställningen. Om du vill reklamera din  
möbel av en annan anledning, rikta du kontakten till Möbelhuset direkt.

**ES** Nuestro servicio directo para accesorios  
Si le falta algún accesorio, puede enviar esta tarjeta de servicio directamente  
a la siguiente dirección. No obstante, por este método solo podemos  
enviar accesorios. Si tiene alguna otra objeción sobre su mueble, consulte  
directamente con su mueblería.

**TR** Doğrudan İhtiyaçlarınızı  
Bir aksesuar eksikliği varsa, lütfen doğrudan aşağıdaki buharan adrese  
doğrudan mail ile ulaşabilirsiniz. Sadece bu yolla doğrudan aksesuarlar  
Möbilyanızda başka bir aksarı varsa, lütfen doğrudan mobilya satıcınıza  
başvurun.

nr	L [mm]	B [mm]	T [mm]	Wenge	Colt
1	1400	400	16	1	1/1
2	900	134	16	1	1/1
3	902	65	16	1	1/1

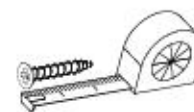
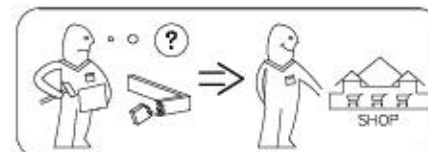
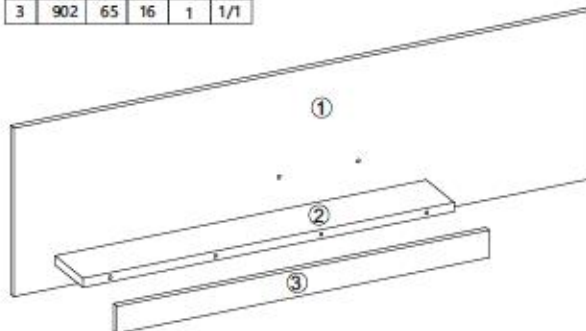

A1 Ø7x50 X...	W2 X...	G52 5x11 X...
P10 X...	I7 X...	K1 X...
K10 X...		

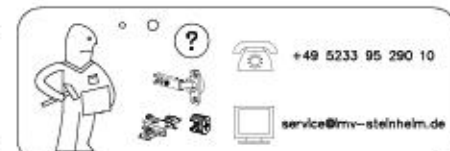

+49 5233 95 290 10

service@mv-steinhelm.de