

SCANDIA V  
8300/2503  
2501/8100

- |           |  |           |   |
|-----------|--|-----------|---|
| <b>D</b>  | MONTAGEANLEITUNG<br>BEDIENUNGSANLEITUNG                | <b>GB</b> | ASSEMBLY INSTRUCTIONS<br>INSTRUCTION MANUAL         |
| <b>NL</b> | HANDLEIDING VOOR DE MONTAGE<br>GEBRUIKSAANWIJZING      | <b>PL</b> | INSTRUKCJA MONTAŻU<br>INSTRUKCJA OBSŁUGI            |
| <b>TR</b> | MONTAJ TALIMATI<br>KULLANIM KLAVUZU                    | <b>RU</b> | ИНСТРУКЦИЯ ПО МОНТАЖУ<br>ИНСТРУКЦИЯ ПО ЭКСПЛУАТАЦИИ |
| <b>RO</b> | INSTRUCȚIUNI DE INSTALARE<br>INSTRUCȚIUNI DE UTILIZARE | <b>IT</b> | ISTRUZIONI DI MONTAGGIO<br>MANUALE DI ISTRUZIONI    |
| <b>FR</b> | NOTICE DE MONTAGE<br>MANUEL INSTRUCTIONS               | <b>SK</b> | MONTÁŽNY NÁVOD<br>NÁVOD NA POUŽITIE                 |
| <b>HU</b> | KÖZGYŰLÉS UTASÍTÁSOK<br>KEZELÉSI UTASÍTÁS              | <b>CZ</b> | MONTÁŽNÍ NÁVOD<br>NÁVOD K POUŽITÍ                   |
| <b>SI</b> | NAVODILA ZA MONTAŽO<br>NAVODILA ZA UPORABO             | <b>PT</b> | INSTRUÇÕES DE MONTAGEM<br>MANUAL DO USUÁRIO         |
| <b>ES</b> | INSTRUCCIONES DE MONTAJE<br>MANUAL DEL USUARIO         | <b>HR</b> | UPUTE ZA MONTAŽU<br>UPUTE ZA UPOTREBU               |

**F**

220412

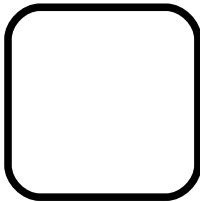
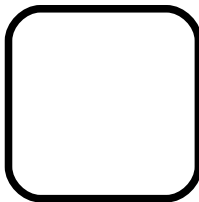

0090

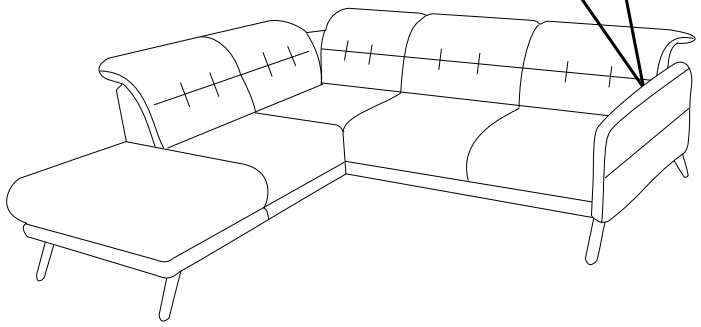
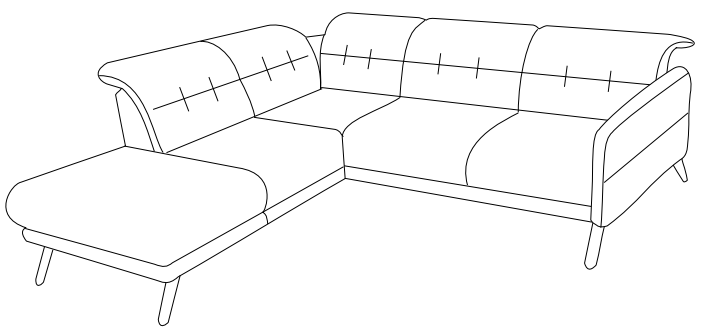
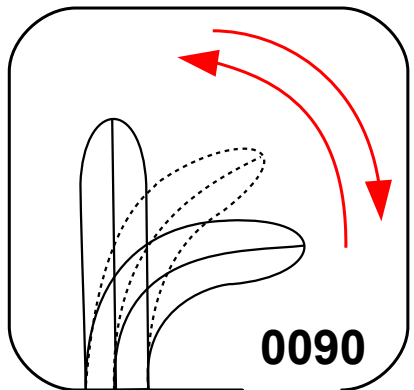

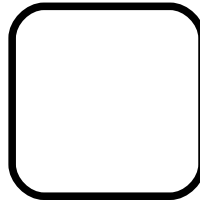
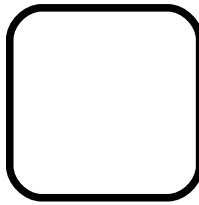

0064

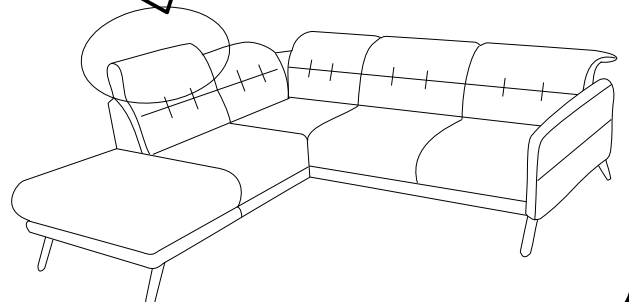
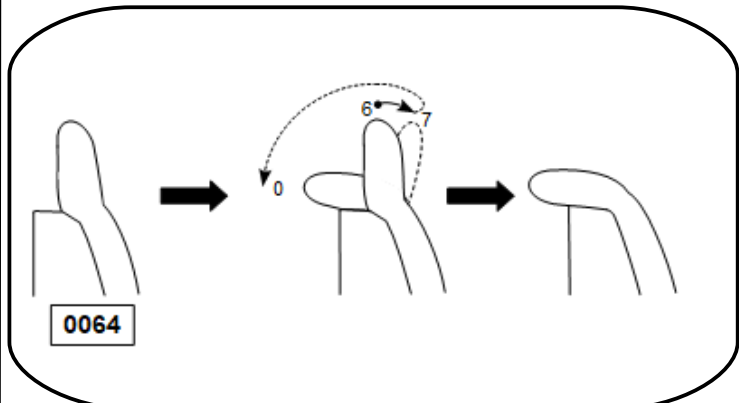
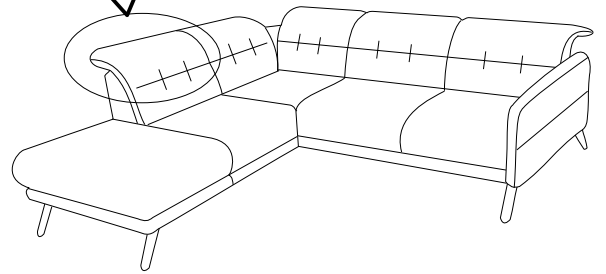
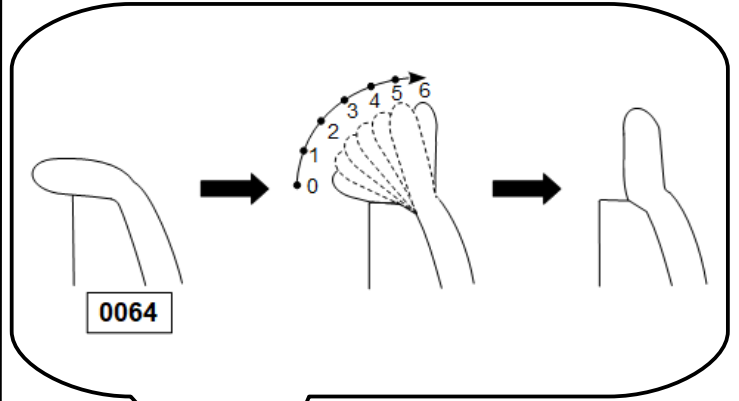
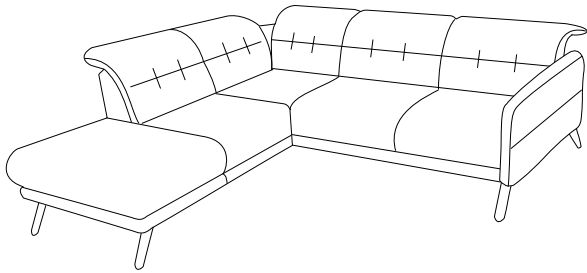





L

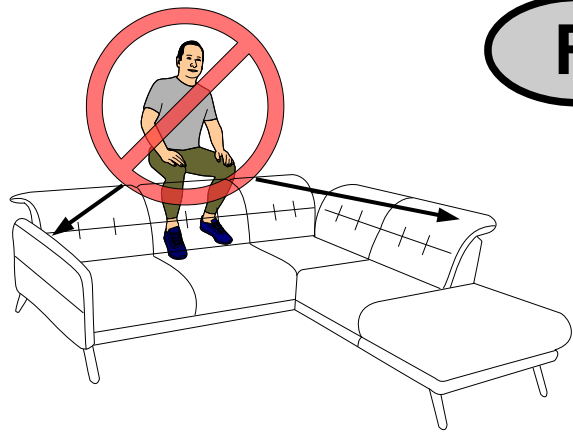





R

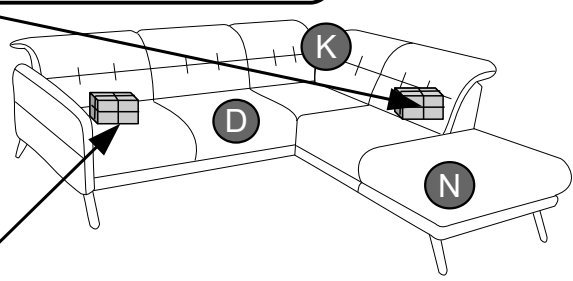
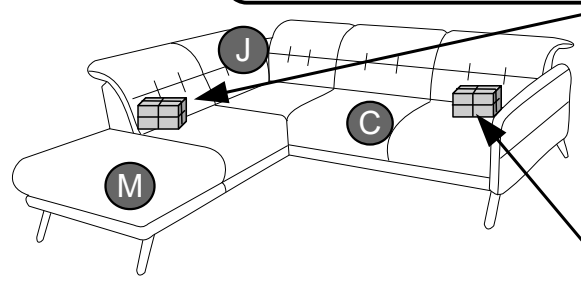

0  
10  
20  
30  
40  
50  
60  
70  
80  
90  
100  
110  
120  
130  
140  
150  
160  
170  
180  
190  
200

|   |   |   |   |  |
|---|---|---|---|--|
| <b>g</b> H-180<br><br>X3 | <b>v</b> H-180<br><br>X1 | <b>i</b> L-5<br><br>X1 | <b>s</b> H-180<br><br><b>s</b> <sub>1</sub><br>X3 | <b>q</b> M8*20 [mm]<br><br>X6 |
|---|---|---|---|--|



|   |   |  |   |
|---|---|--|---|
| <b>g</b> H-180<br><br>X1 | <b>i</b> L-5<br><br>X1 | <b>s</b> H-180<br><br><b>s</b> <sub>1</sub><br>X2 | <b>q</b> M8*20<br><br>X4 |
|---|---|--|---|

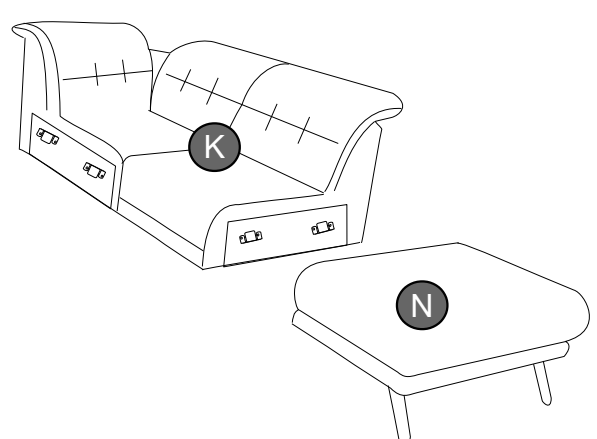
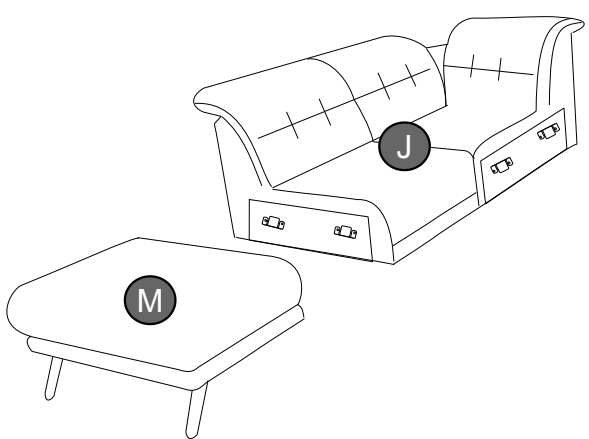
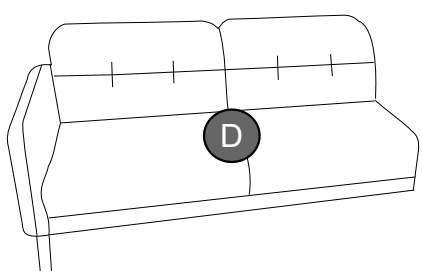
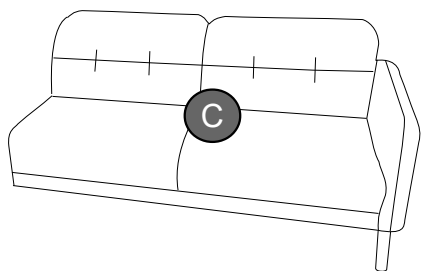

**g** H- 180

X4

**v** H- 180

X1

**i** L- 5

X1

**s** H- 180

**s**<sub>1</sub>

X5

**q** M8\*20

X10

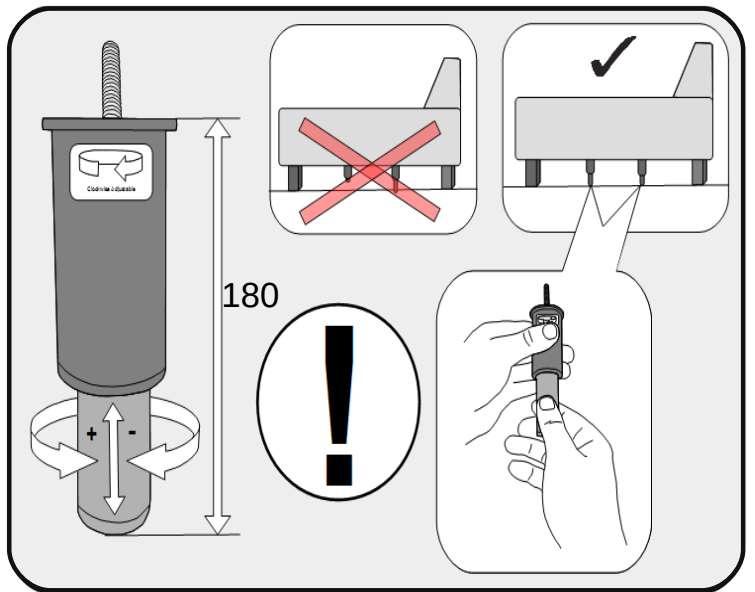
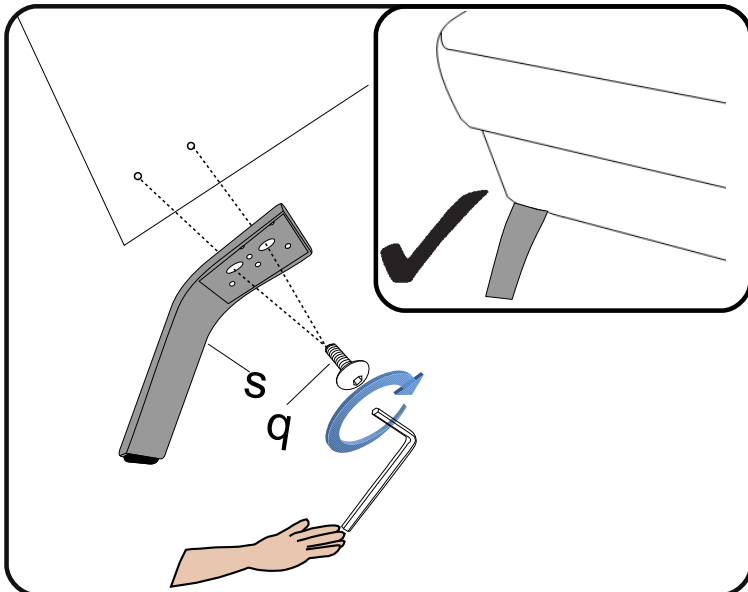
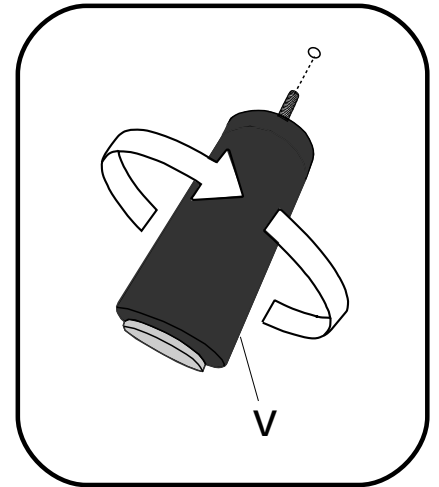
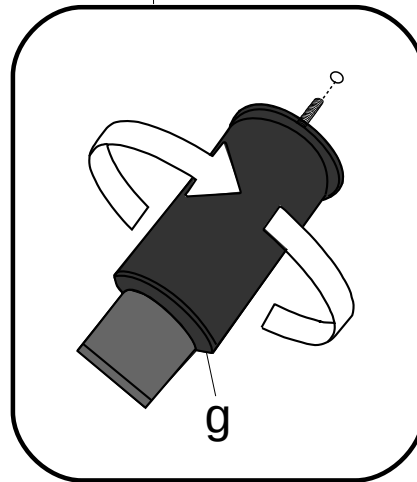
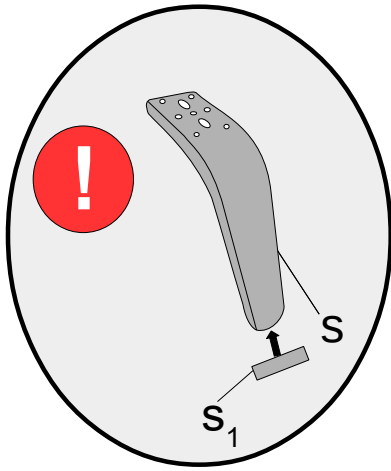
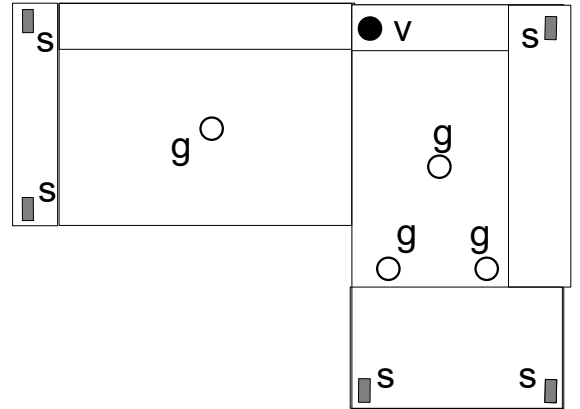
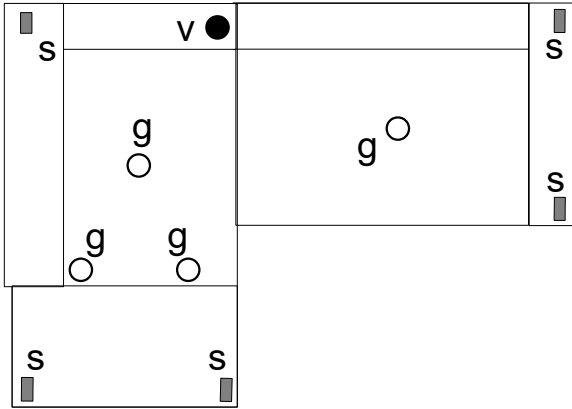
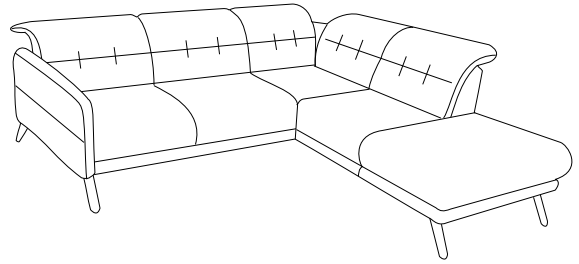
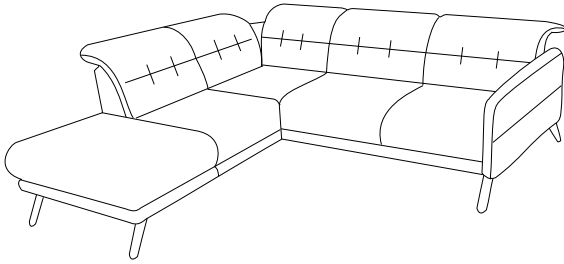

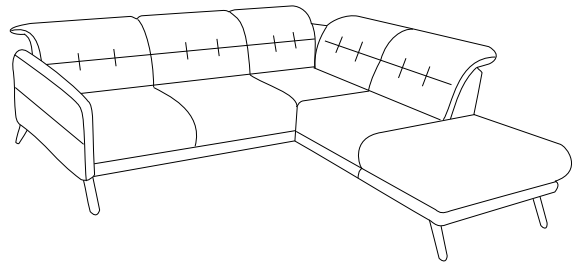
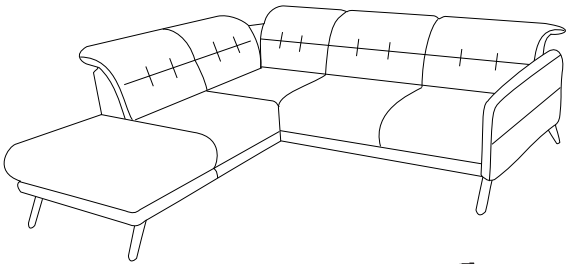
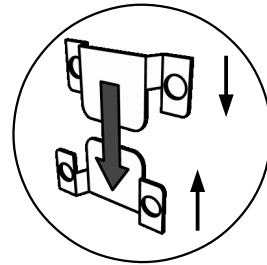
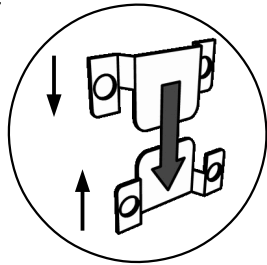
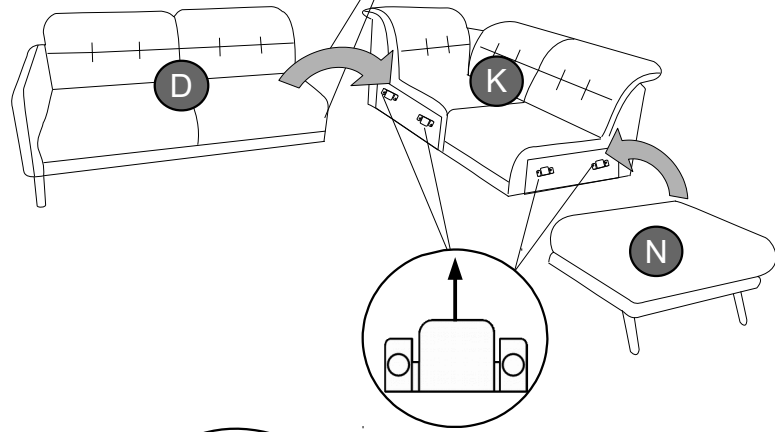
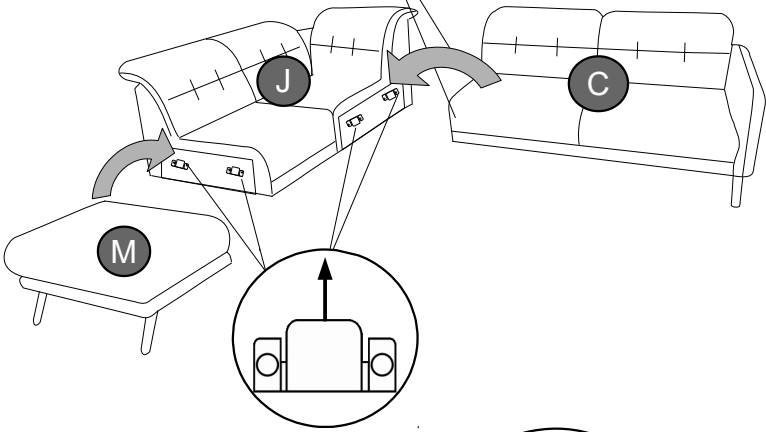
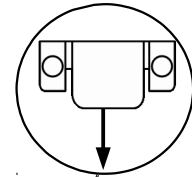
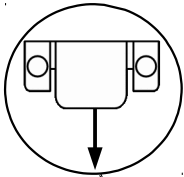
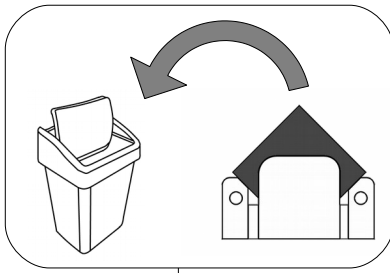

Service · Dienstverlening · Servis · Servis · Сервисная служба · Serviciu · Services · Servizio  
 · Servisný list · Szolgáltatás · Servisní list

Name · Naam · Nazwa · İsim · Название · Nume · Nome · Názov · Názov ·  
 Název · Neve

**SCANDIA V**

Typ · Type · Tip · Тип · Tipo · Típus

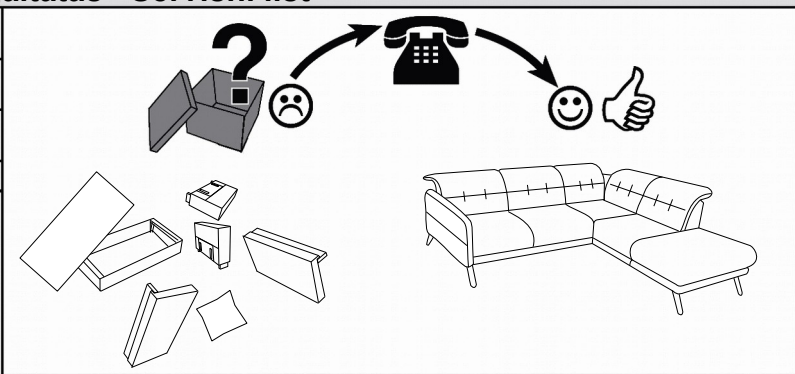
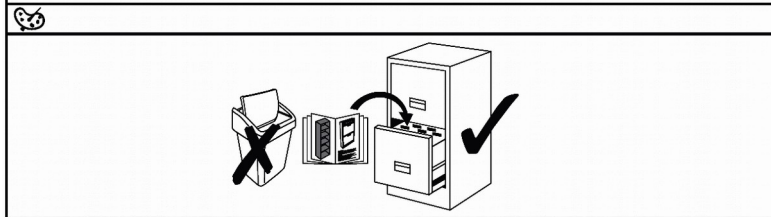

**L**

**R**

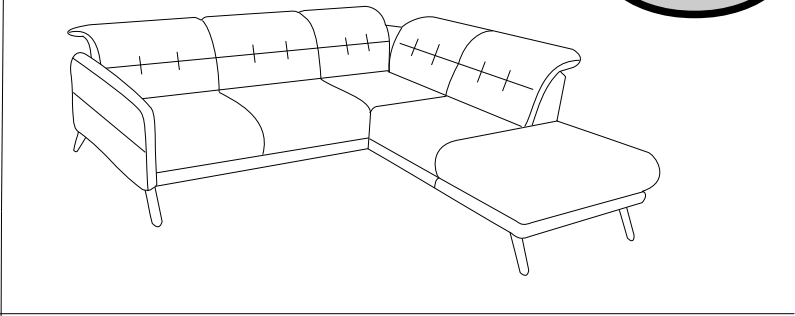
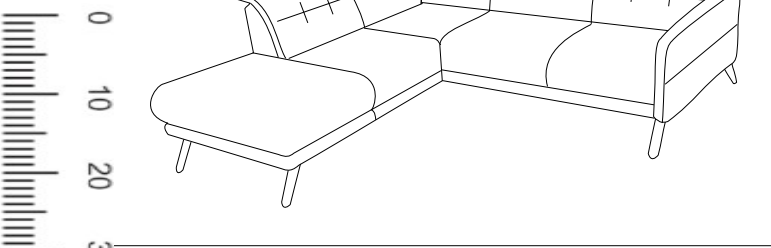

|                    |                    |                  |   |                         |
|--------------------|--------------------|------------------|---|-------------------------|
| <b>g</b> H-180<br> | <b>v</b> H-180<br> | <b>i</b> L-5<br> | <b>s</b> H-180<br><br><b>s</b> <sub>1</sub> | <b>q</b> M8*20 [mm]<br> |
|--------------------|--------------------|------------------|---|-------------------------|

