

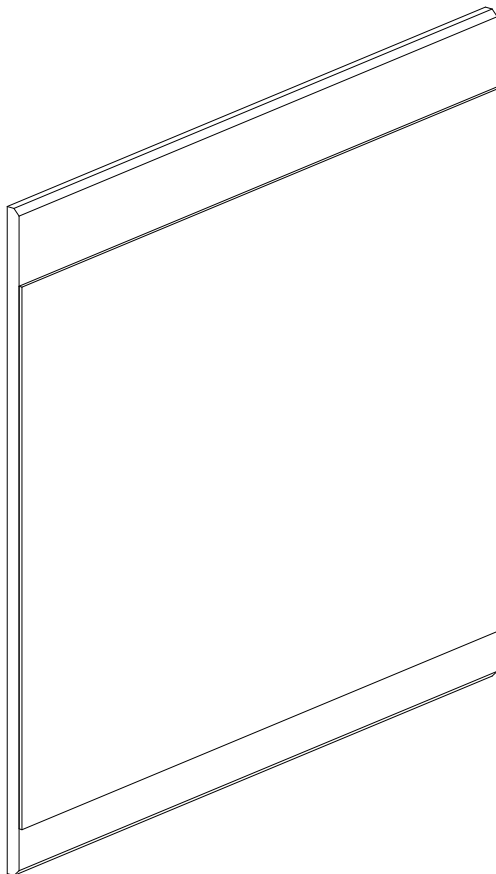

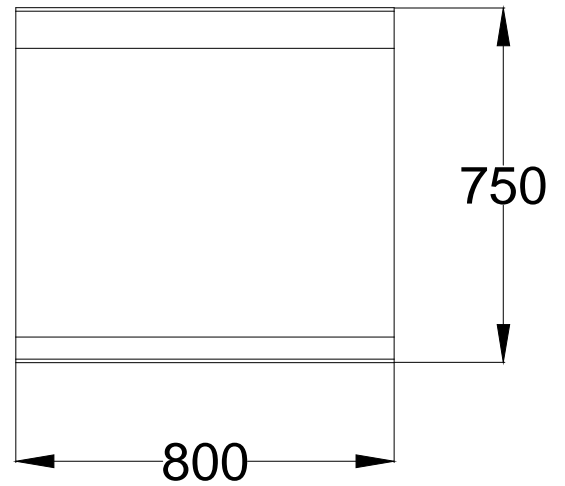
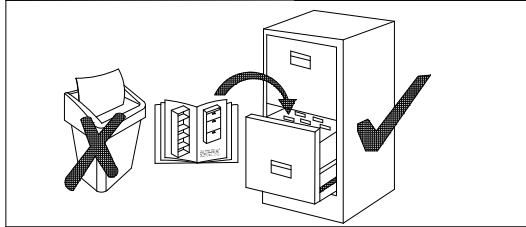
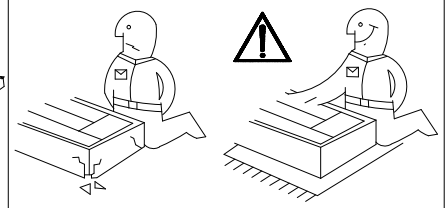
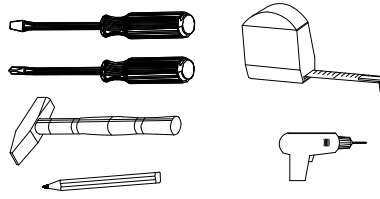
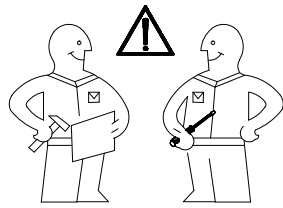

NOLA Spiegel

54-055-T2E

Nr 1/4

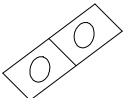

	$\text{\O}5 \times 11 \text{mm}$		$\text{\O}8 \times 40 \text{mm}$
A	x2	B	x4
			
C	x3	D	x2



NOLA Spiegel

54-055-T2E

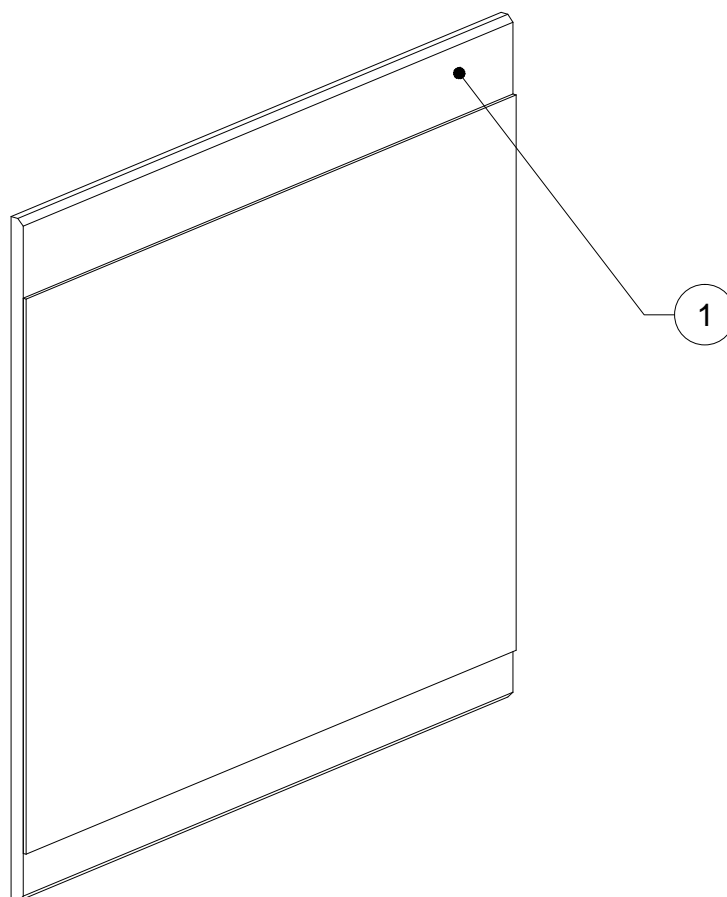
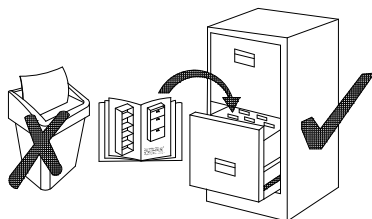
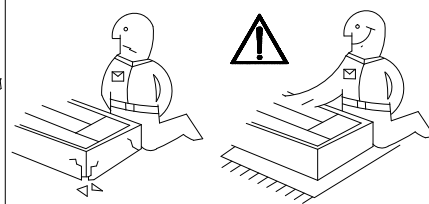
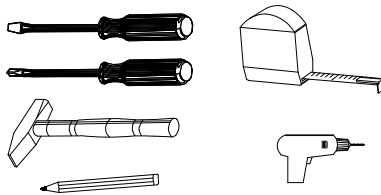
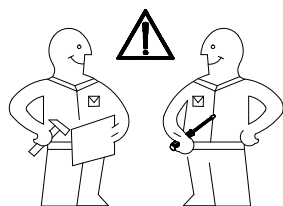
Nr 2/4

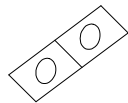

1	750x800x16	x1
---	------------	----

	$\varnothing 5 \times 11 \text{mm}$				
A	x2	B	x4	C	x3

