



D Montageanleitung

F Notice de montage

NL Handleiding voor de montage

CZ Monzáni návod

HU Szerelési útmutató

TR Montaj talimatı

GB Assembly instructions

I Istruzione di montaggio

PL Instrukcja montaży

SK Návod na montáž

RO Instrucțiuni de montaj

RU ИНСТРУКЦИЯ ПО МОНТАЖУ

Art. Nr.

3742-E-01

90 x 200 cm

120 x 200 cm

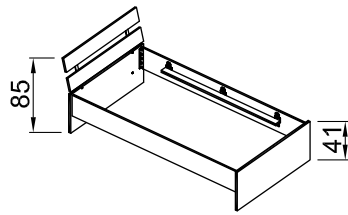
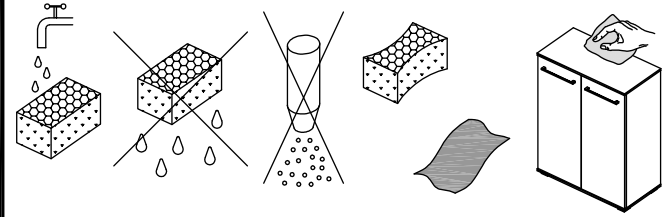
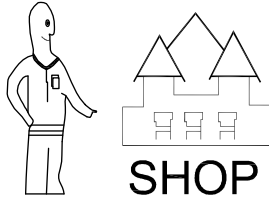

Art. Nr.

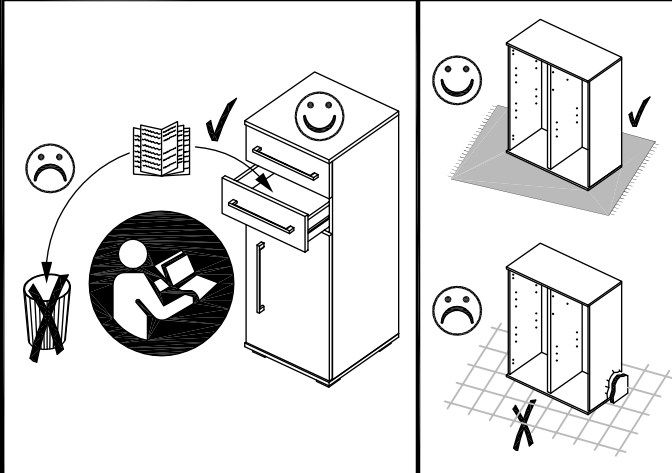
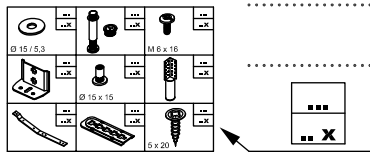
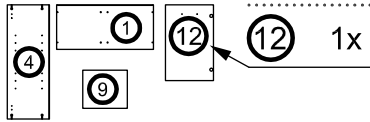

	99
Ø 18 / 6,4	4x
	123
	6x
	124
4 x 17	12x
	335
M 6 x 16	4x
	561
5 x 16	28x
	563
M 6 x 20	4x
	564
	2x
	566
Ø 15 x 15	8x

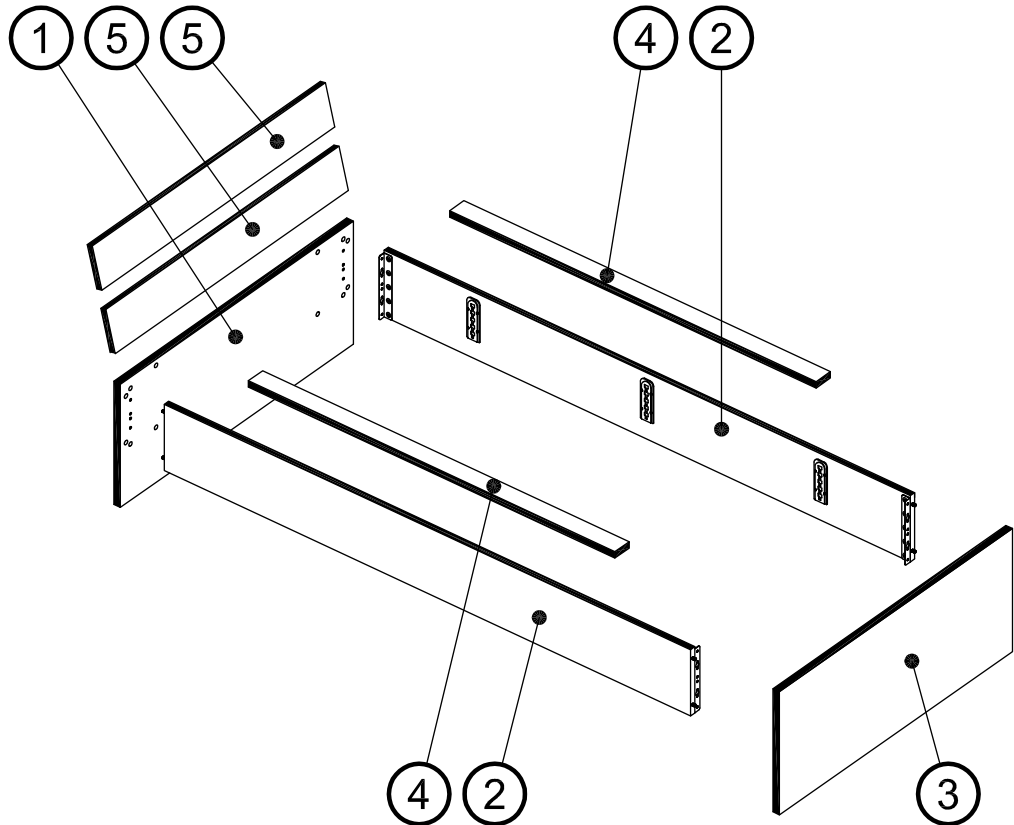

1

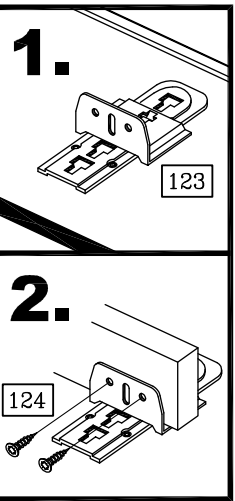
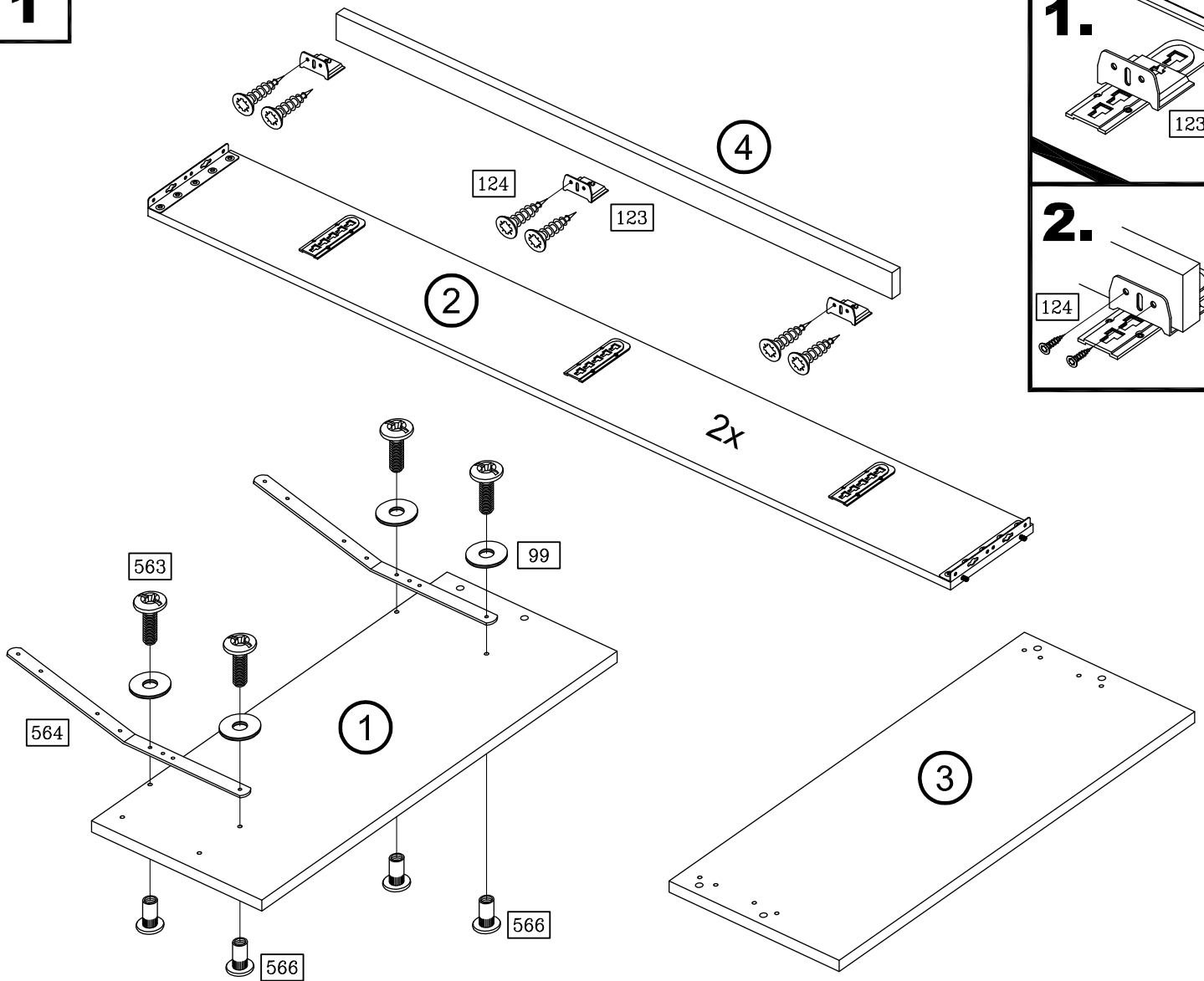

2

