

Art. Nr. 2846096

1/6

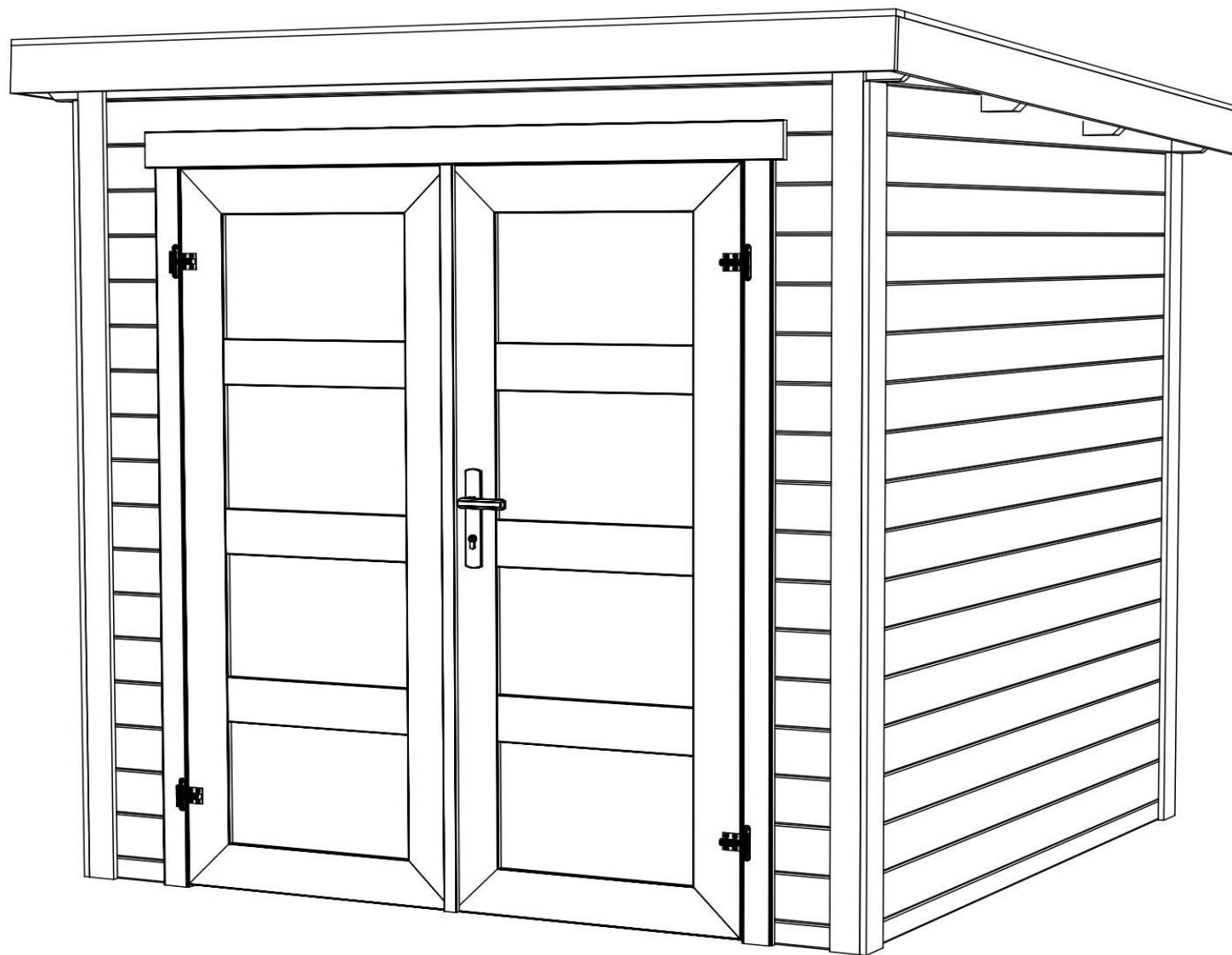

12.02.2020

Groundplan - Grundplan - Plan de masse -  
Planimetria - Plattegrond - Põhiplaan

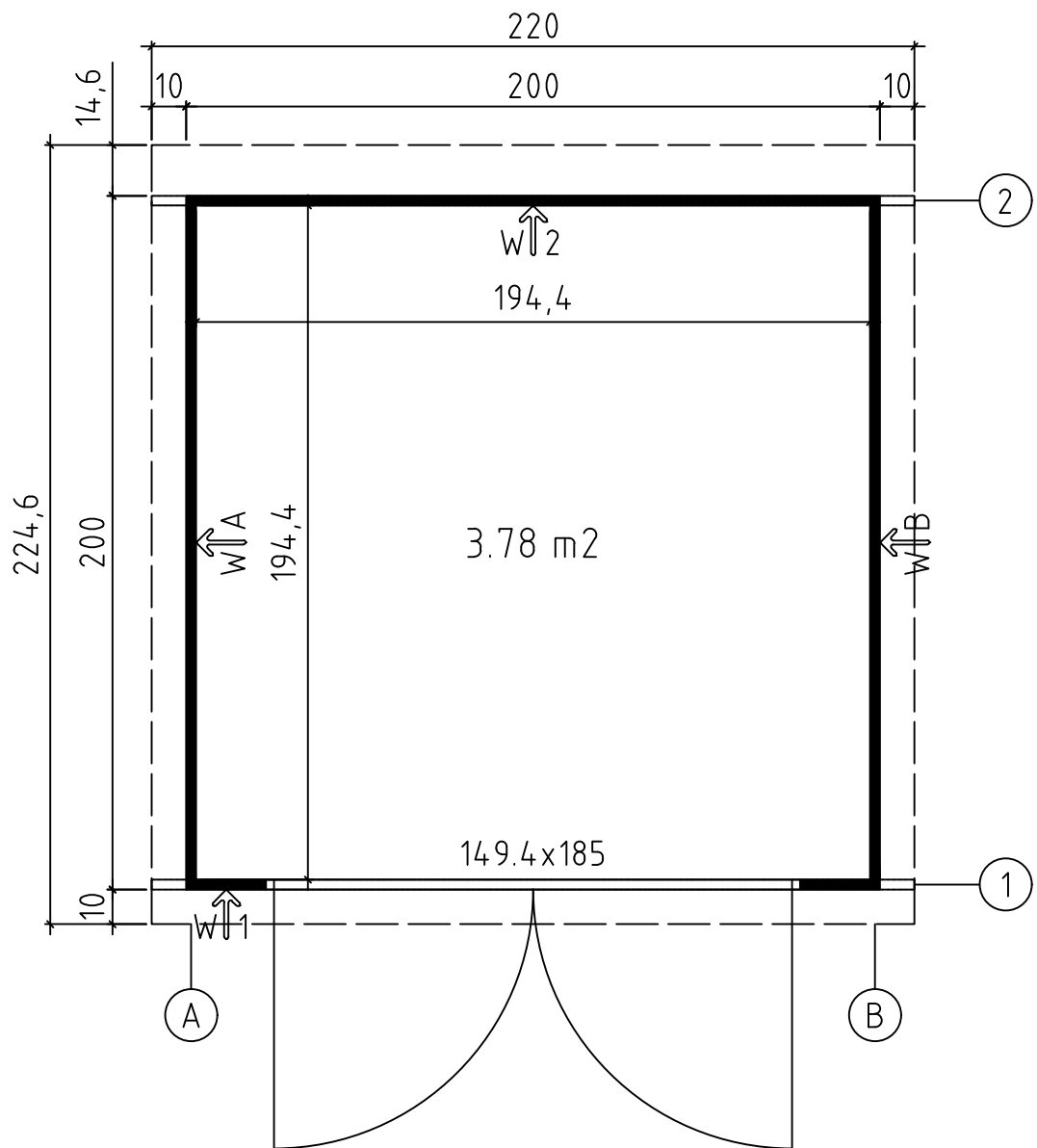



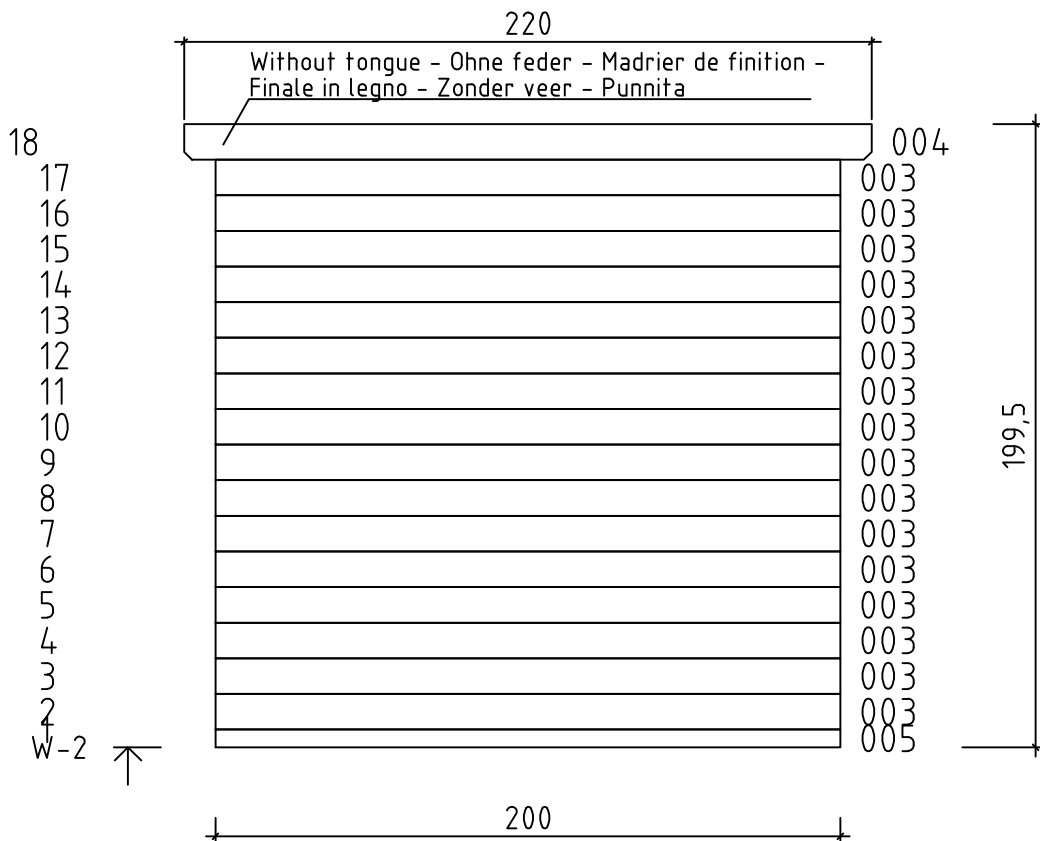
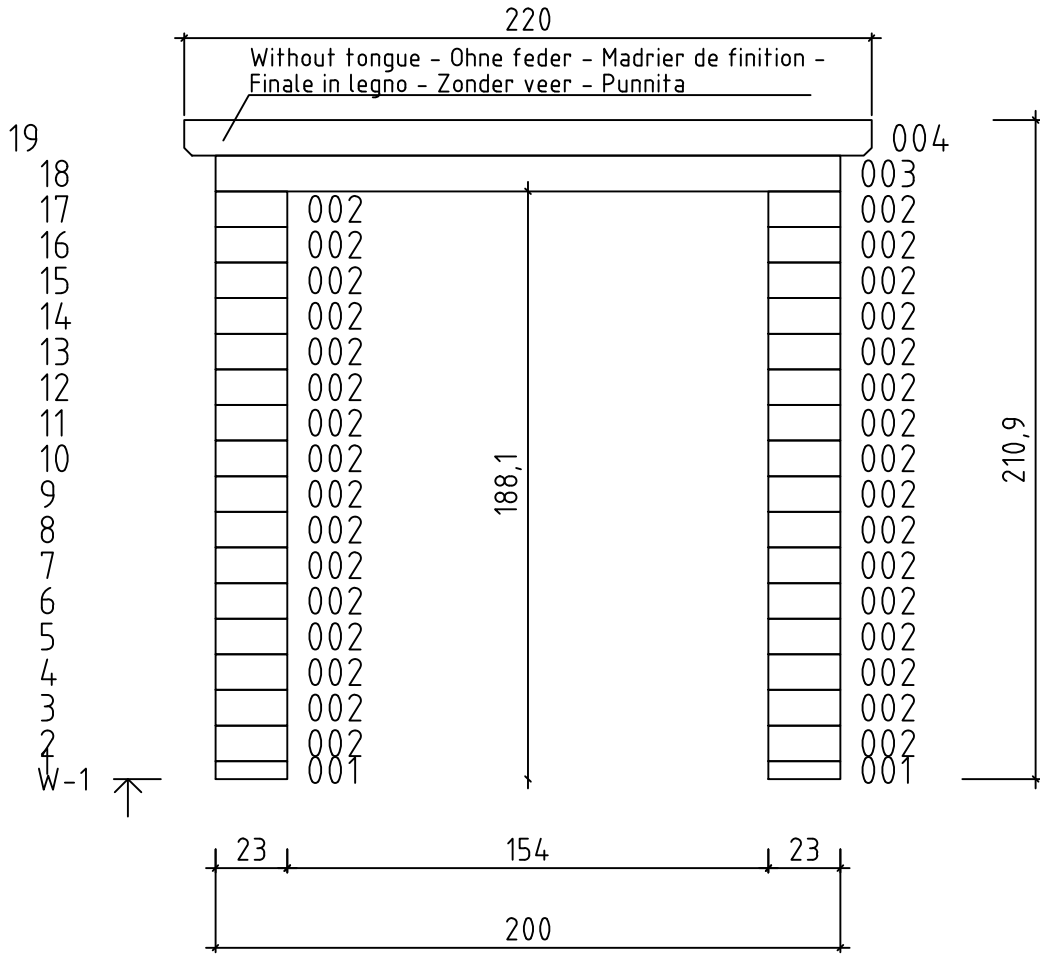



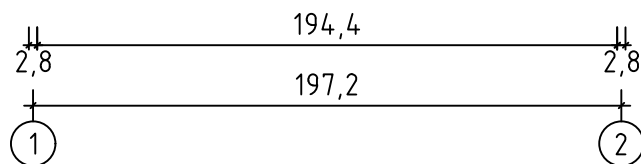
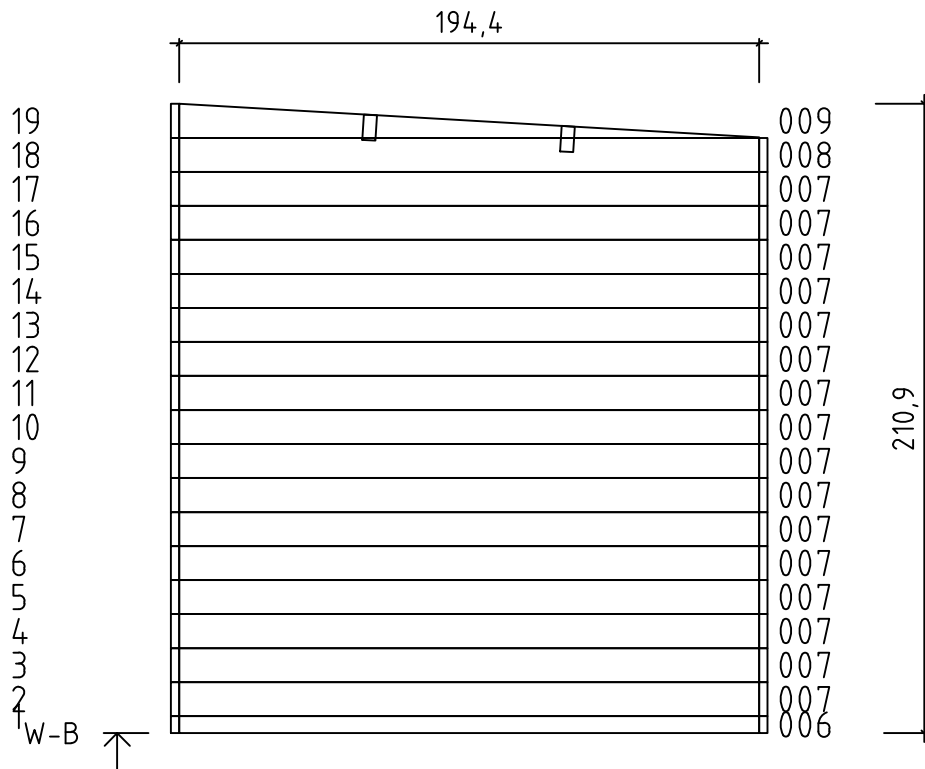
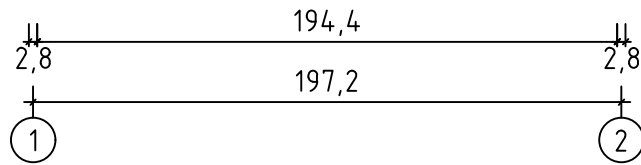
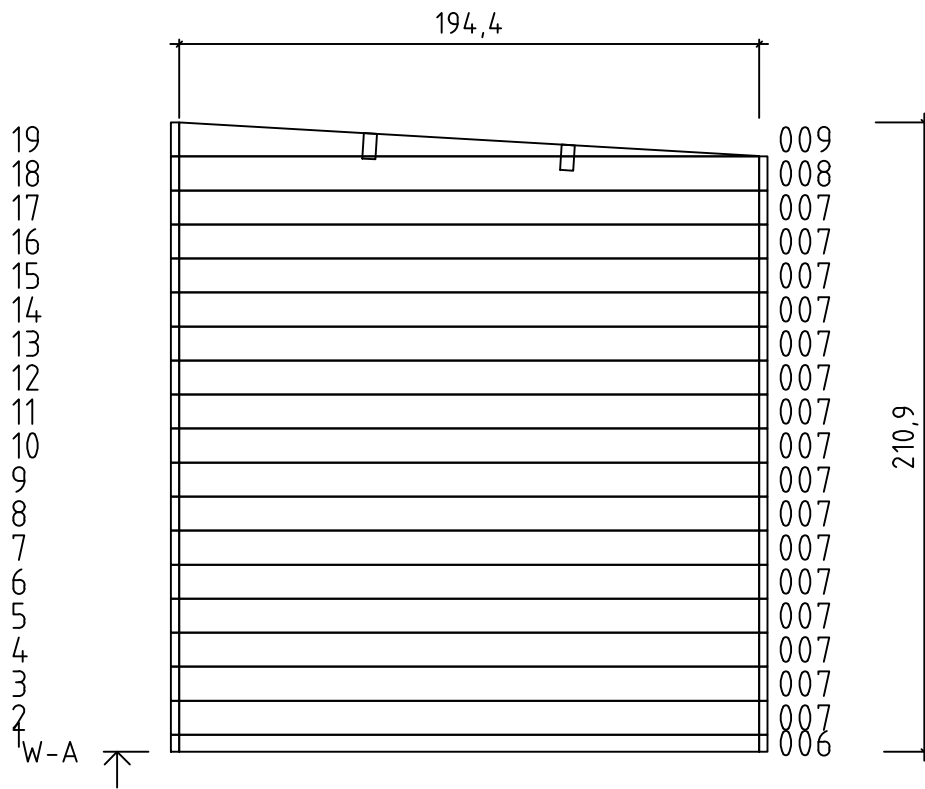





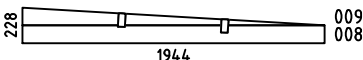
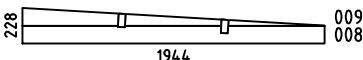
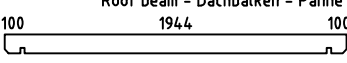

Art. Nr. 2846096



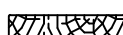
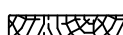
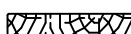
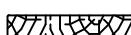



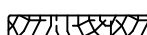
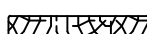

Art. Nr. 2846096

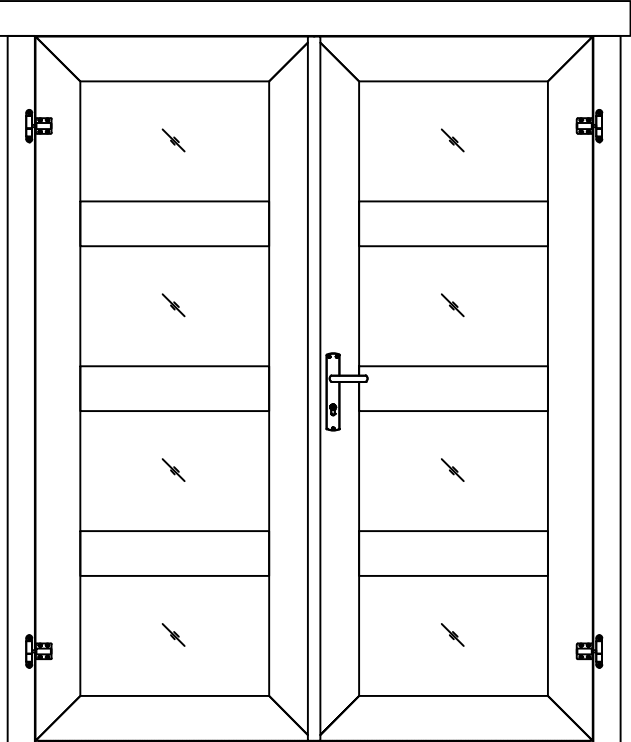
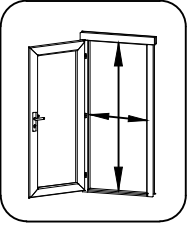

| Pos   | 12.02.2020<br>Piece list - Stückliste - Liste des pièces - Elementi - Stuklijst - Tükítabel<br>Art. Nr. 2846096  | 5/6 | Q  | P<br>(mm) | L<br>(mm) |
|-------|--|-----|----|-----------|-----------|
| 001   |   |     | 2  | 28x57     | 230       |
| 002   |   |     | 32 | 28x114    | 230       |
| 003   |   |     | 17 | 28x114    | 2000      |
| 004   |   |     | 2  | 28x114    | 2200      |
| 005   |   |     | 1  | 28x57     | 2000      |
| 006   |   |     | 2  | 28x57     | 1944      |
| 007   |   |     | 32 | 28x114    | 1944      |
| WA-1  |   |     | 1  |           |           |
| WB-1  |   |     | 1  |           |           |
| A-PR1 | Roof beam - Dachbalken - Panne de toit - Perlina del tetto - Gordingen / dakbalk - Pärlin<br>   |     | 2  | 44x120    | 2200      |
| DB    | Roof boards - Dachbretter - Voliges - Perlina per tetto - Dakhout - Katuselaud<br>  |     | 25 | 90x15     | 2250      |
| RFF1  | Roofing felt fillet - Dachpappenleiste - Baguette de fixation du feutre bitumeux - Asse per fissaggio guaina bituminosa - Afdeklíjst asfaltpapier - Katusepapiilist<br> |     | 1  | 15x45     | 2230      |
| RFF2  | Roofing felt fillet - Dachpappenleiste - Baguette de fixation du feutre bitumeux - Asse per fissaggio guaina bituminosa - Afdeklíjst asfaltpapier - Katusepapiilist<br> |     | 2  | 15x45     | 2270      |
| DL1   | Corner fillet - Deckleiste - Profils de finition angles a l'exterieur - Massello d'angolo - (hoek)lijst - Nurgaliist<br>  |     | 2  | 15x70     | 1995      |
| DL2   | Corner fillet - Deckleiste - Profils de finition angles a l'exterieur - Massello d'angolo - (hoek)lijst - Nurgaliist<br>  |     | 2  | 15x70     | 2109      |
| DL3   | Corner fillet - Deckleiste - Profils de finition angles a l'exterieur - Massello d'angolo - (hoek)lijst - Nurgaliist<br>  |     | 2  | 15x90     | 1881      |
| DL4   | Corner fillet - Deckleiste - Profils de finition angles a l'exterieur - Massello d'angolo - (hoek)lijst - Nurgaliist<br>  |     | 2  | 15x90     | 1995      |
| EP1   | Corner stud - Eckpfosten - Poteaux d'angle pour fixation des madriers - Perno angolare - Hoek staander (kolom) - Nurgapost<br>  |     | 2  | 44x44     | 1970      |
| EP2   | Corner stud - Eckpfosten - Poteaux d'angle pour fixation des madriers - Perno angolare - Hoek staander (kolom) - Nurgapost<br>  |     | 2  | 44x44     | 2080      |
| TB    | Fascia board - Traufbrett - Bandeau de toit - Finitura lati tetto - Gevellijst - Räästalaud<br>   |     | 1  | 15x45     | 2200      |
| TL    | Fixing fillet - Fixirungsleiste - Profil de fixation - Massello di fissaggio - Bevestiging lijstwerk - Tenderliist<br>  |     | 2  | 18x28     | 1850      |
| GL1   | Gable moulding - Giebelleiste - Planche de rive - Finitura per frontale e retro del tetto - Gevellijst - Viilulaud<br>  |     | 1  | 15x120    | 2230      |
| GL2   | Gable moulding - Giebelleiste - Planche de rive - Finitura per frontale e retro del tetto - Gevellijst - Viilulaud<br>  |     | 2  | 15x120    | 2300      |



| Pos | Piece list - Stückliste - Liste des pièces - Elementi - Stuklijst - Tükitabel<br>1494x1850 TUK.4.020.MXVP.MMX28 MXGA+28   | 1/2   | Q | P<br>(mm) | L<br>(mm) |
|-----|---|---|---|-----------|-----------|
|     | Glass size - Glasgröße - Taille de la vitre - Misura del vetro - Glas afmeting - Klaasi mõõt: 502x325 mm  |   |   |           |           |
|     |   <p>1418x1792 mm</p> |   |   |           |           |
| 1   | Upper door jamb - Türrahmen oben - Cadre de porte supérieur -<br>Telaio superiore della porta - Bovendorpel - Ukse ülemine leng   |  | 1 | 66x100    | 1438      |
| 2   | Left door jamb - Türrahmen links - Cadre de porte gauche -<br>Telaio montante sinistro della porta - Linkerstijl deurframe - Ukse vasak leng  |  | 1 | 66x80     | 1850      |
| 3   | Right door jamb - Türrahmen rechts - Cadre de porte droit -<br>Telaio montante destro della porta - Rechterstijl deurframe - Ukse parem leng  |  | 1 | 66x80     | 1850      |
| 4   | Doorstep - Swelle - Barre de seuil -<br>Soglia della porta - Deurdorpel - Lävepak   |  | 1 | 20x21     | 1418      |
| 5   | Connection strip - Deckleiste - Baguette de battement - Profilo verticale della<br>porta - Stulplijst - kokkuvaltsiliist  |  | 1 | 13x32     | 1812      |





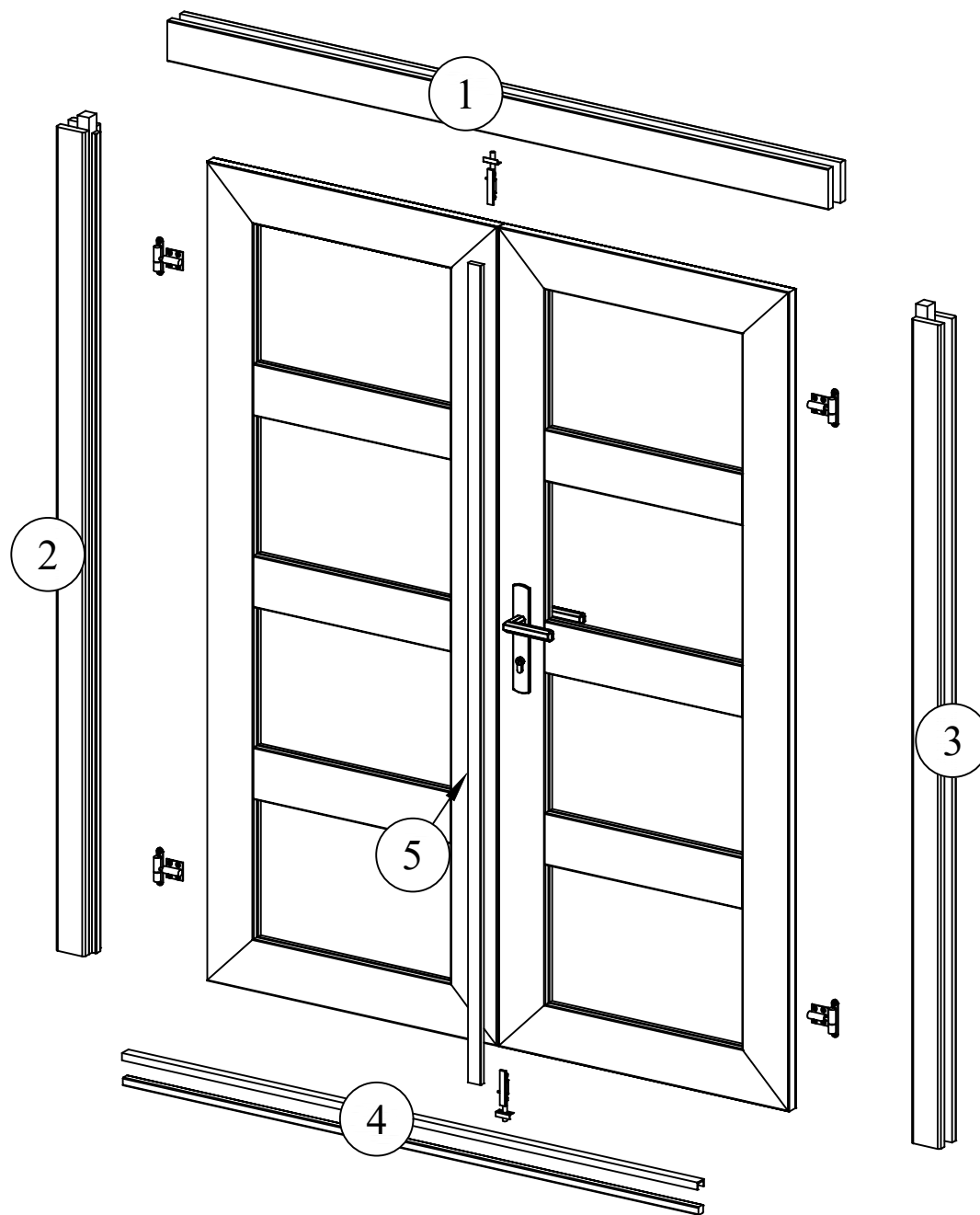

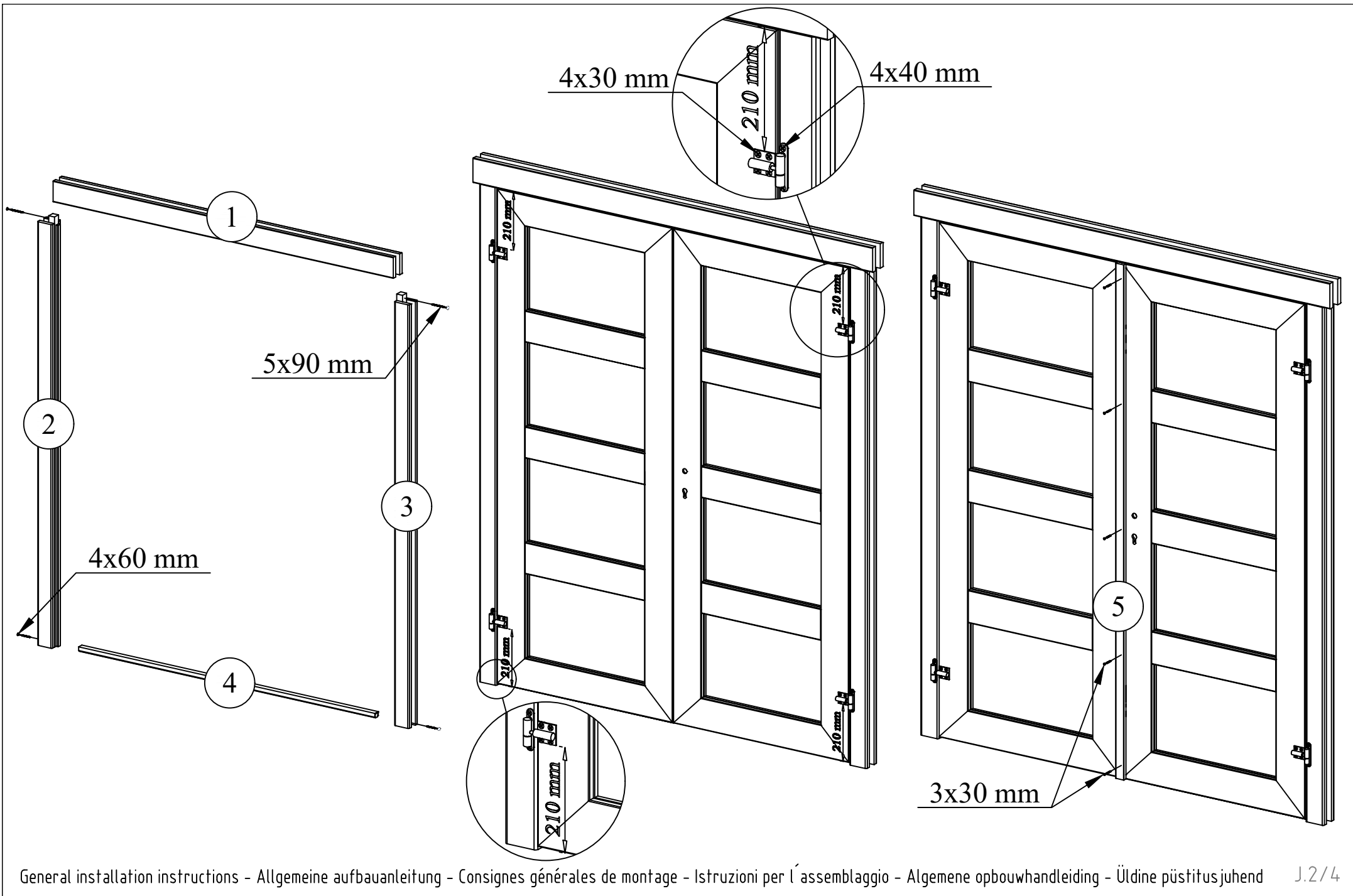

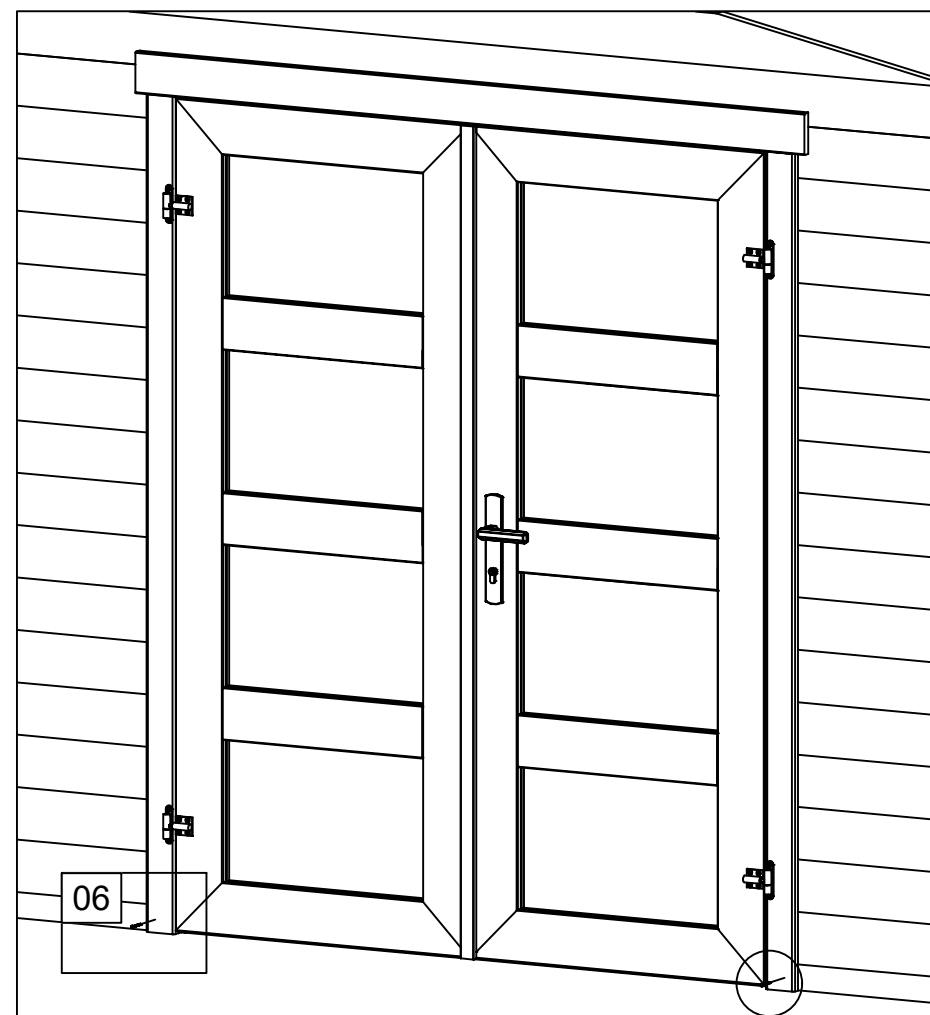
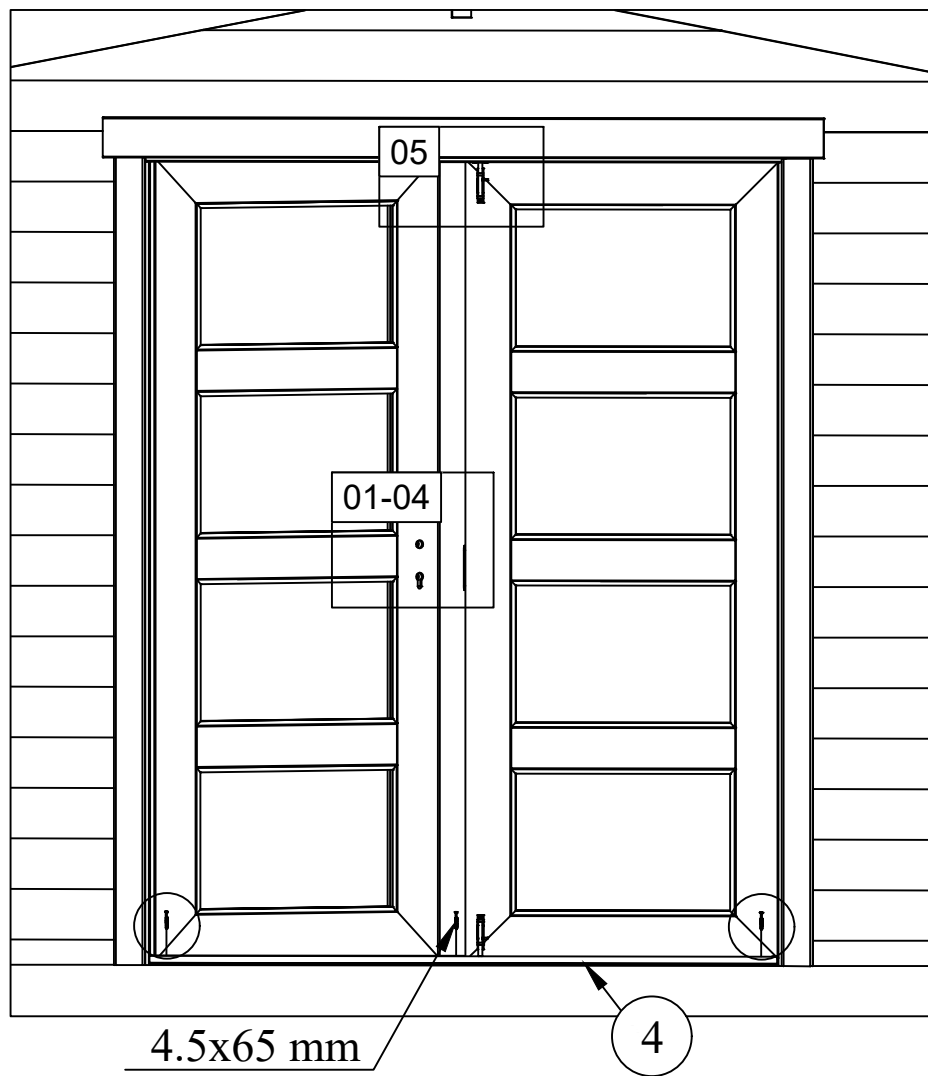

01

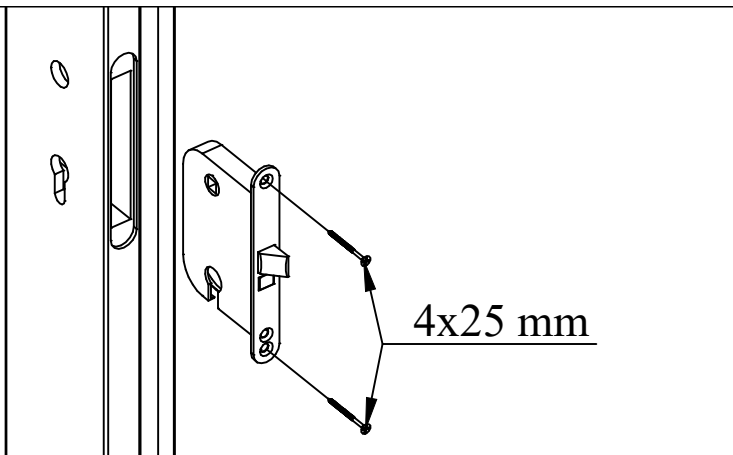

04



02



05



03



06

