



(D) Videounterstützte Montageanleitung

(TR) Video destekli kurulum talimatları

(RU) инструкция по монтажу с помощью видеосигнала

(RO) Instrucțiuni de instalare acceptate video

(GB) Video-assisted assembly instructions

(IT) Istruzioni di montaggio video-assistite

(CZ) Instalační pokyny podporované videem

(PL) Instrukcje montażu wspomagane sygnałem wizyjnym

(FR) Instructions de montage assistées par vidéo

(NL) Video-ondersteunde montage-instructies

(HU) Video-támogatott telepítési utasítások

(SK) Inštaláčne pokyny podporované videom

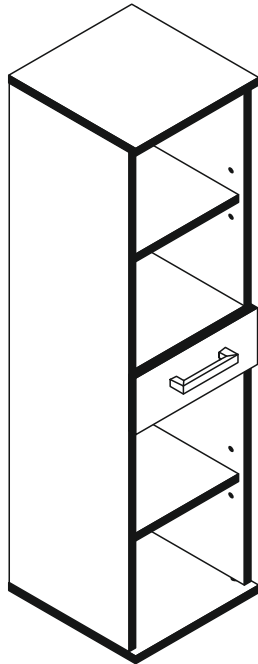

0454_01-M

REPC-Nr.:

Standregal mit Applikation

Service • Assistenza • Dienstverlening • Serwis
Servis • Szerviz • Сервисная служба

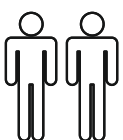
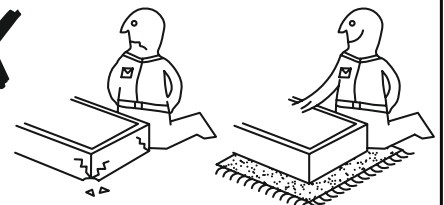
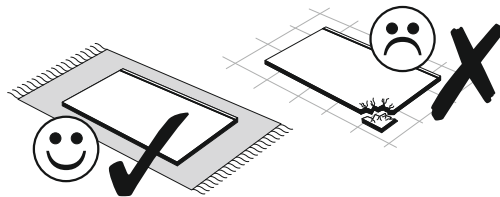
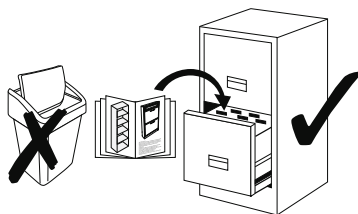
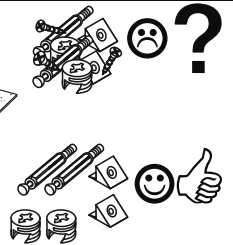
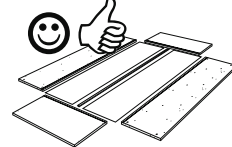
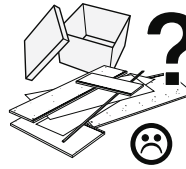
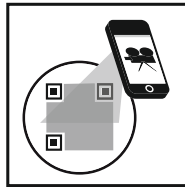
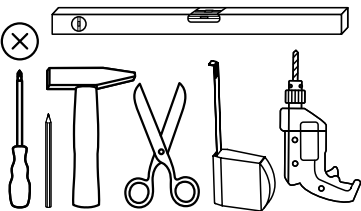

Das Ersatzteil-Anforderungsformular finden Sie auf <https://www.maeusbacher.de/ersatzteile/>

| | | | | | | | |
|-------------|--|-------------|--|-------------|--|-------------|--|
| 1-10 4x | | 1-30 3x | | 1-90 8x | | 1-122 4x | |
| 1-200 4x | | 1-330 2x | | 2-10 8x | | 2-20 8x | |
| 3-130 2x | | 5-20 4x | | 5-80 8x | | 5-130 1x | |
| 5-185 4x | | 6-194 1x | | 1-150 2x | | 2-170 4x | |
| | | | | | | 5-140 6x | |

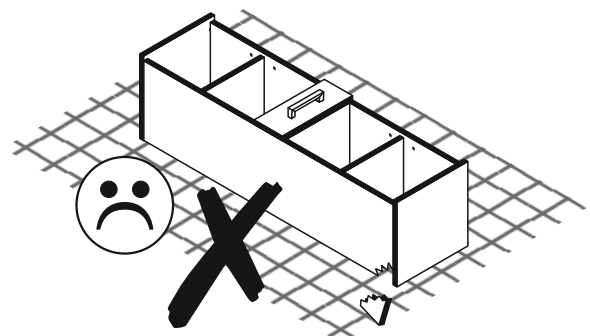
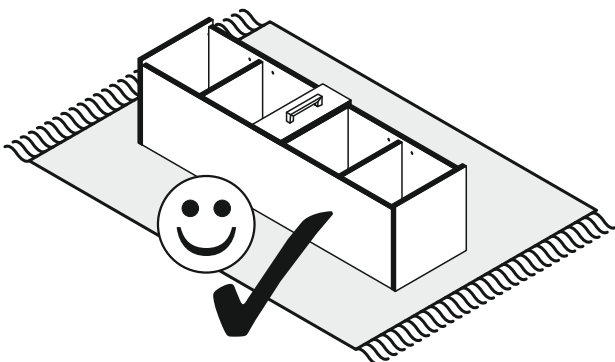
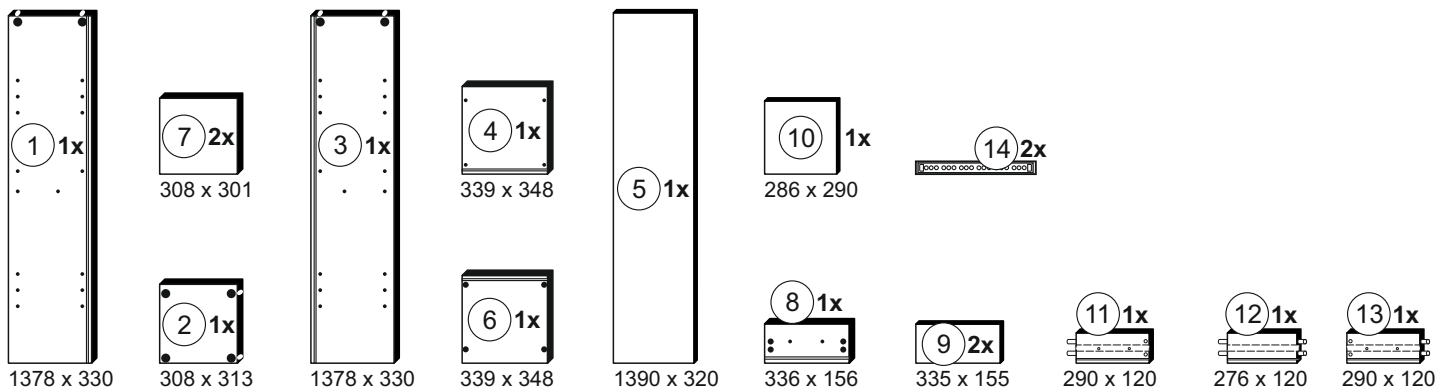
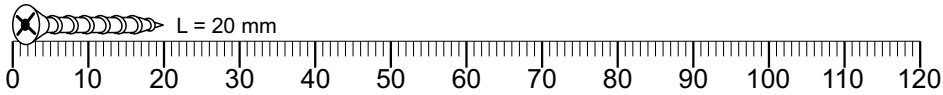
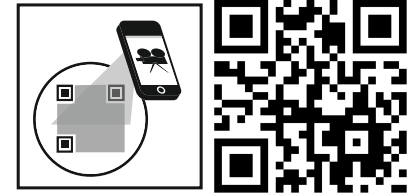

1

| | | | | | | | | | |
|-------|--------|------|--|------|--|------|--|----|---|
| 1-200 | | 2-10 | | 2-20 | | 5-80 | | 1 | 3 |
| 4x | 6,3x13 | 4x | | 4x | | 8x | | 14 | |

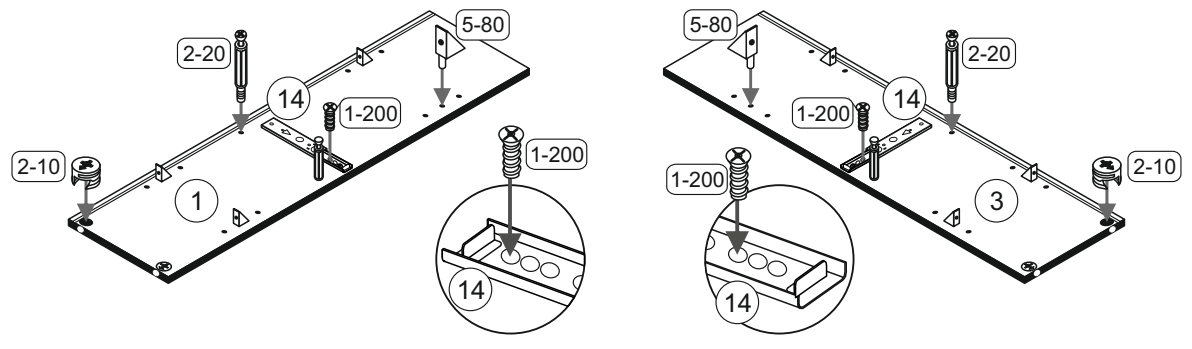

2

| | | |
|------|--|---|
| 2-10 | | 2 |
| 4x | | |

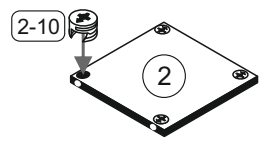

3

| | | |
|------|--|---|
| 2-20 | | 4 |
| 4x | | |

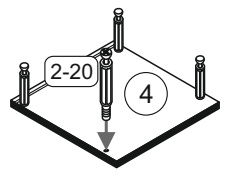

4

| | | | | | | |
|-------|--------|-------|--|----|----|----|
| 1-150 | | 3-130 | | 8 | 9 | 10 |
| 2x | 4x35 | 2x | | 11 | 12 | 13 |
| 5-130 | | 5-140 | | | | |
| 1x | LEIM | 6x | | | | |
| 6-194 | | | | | | |
| 1x | 128 mm | | | | | |

- 8
- 9
- 10
- 11
- 12
- 13

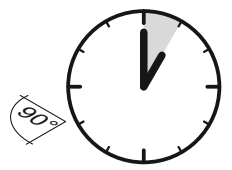
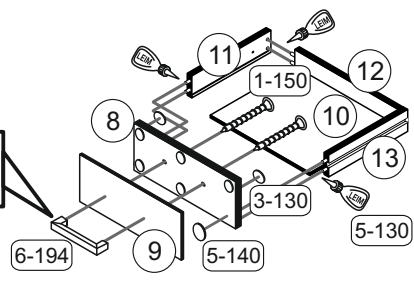

5

| | |
|------|--|
| 5-20 | |
| 4x | |

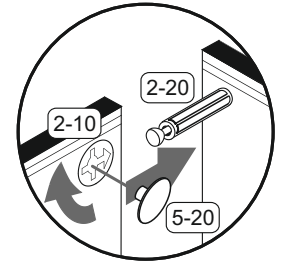
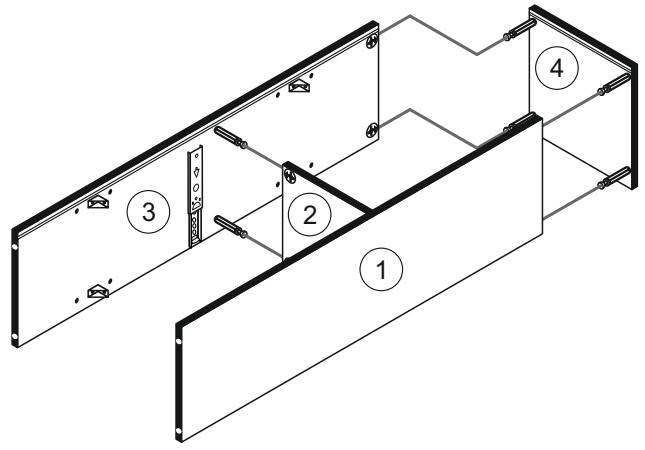

| | | | | | | | | | | |
|---|------|--|------|--|------|--|-------|--|-------|--|
| 6 | 1-10 | | 1-30 | | 1-90 | | 2-170 | | 5-185 | |
| | 4x | | 3x | | 8x | | 4x | | 4x | |

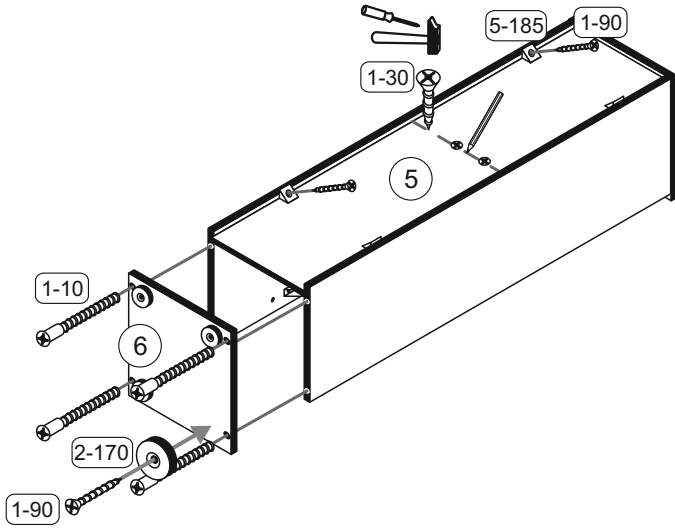
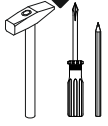

| | | | | |
|---|-------|--|-------|--|
| 7 | 1-122 | | 1-330 | |
| | 4x | | 2x | |

