

Installation sanleitung
Installation Instruction
Instruction d'installation

Daybett

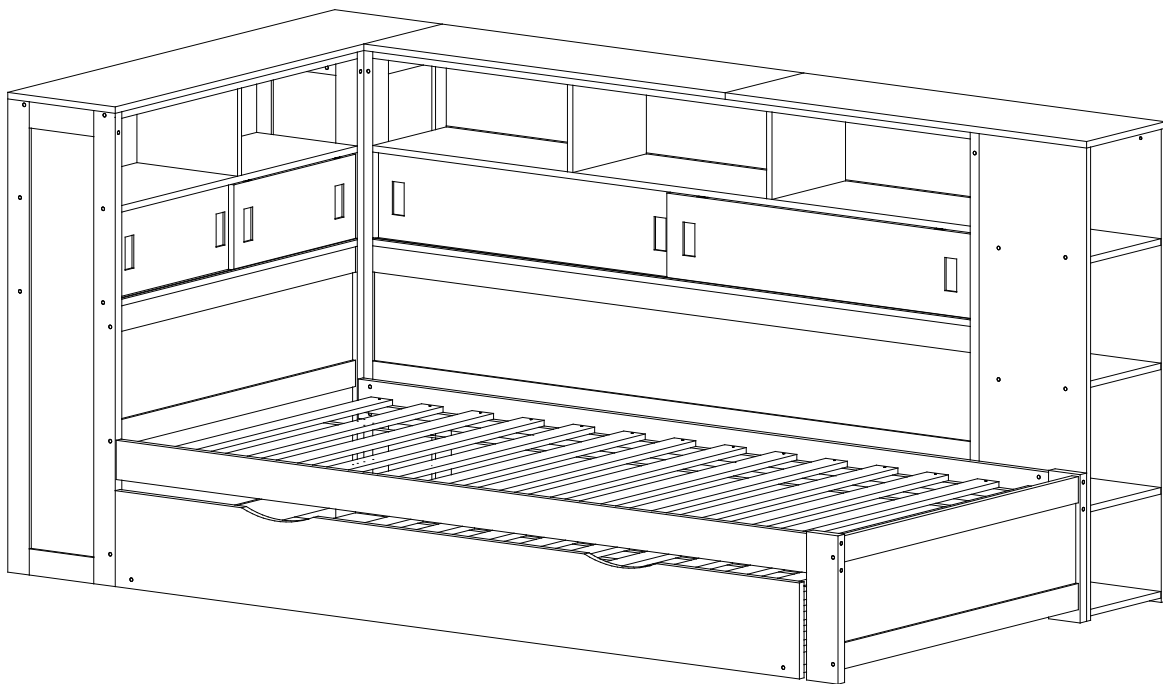

Unser Produkt wird Ihnen in 4 Paketen geliefert. Die Lieferzeiten dieser 4 Pakete können abweichen, bitte haben Sie etwas Geduld und vielen Dank für Ihr Verständnis.

Our product will be delivered to you in 4 packages. The delivery times of these 4 packages may differ, please be patient and thank you for your understanding.

Notre produit vous sera livré en 4 colis. Les délais de livraison de ces 4 colis peuvent différer, soyez patient et merci pour votre compréhension.



FR

Vous êtes responsable de remettre tous les appareils électriques et électroniques usagés à des points de collecte correspondants.

Pour en savoir plus:
www.quefairedelesdechets.fr

N636P211133/N636P211134/N636P211135/N636P211136

English

IMPORTANT ! KEEP FOR FUTURE REFERENCE : READ CAREFULLY

- To be assembled by an adult. Assembly must be checked by an adult before use
- WARNING ! Keep all screws, small parts and plastic bags out of the reach of children
- Properly identify all parts before assembling
- Never use your item if any of its parts are broken or missing
- Should any problems arise, please contact our After Sales Service
- Manufacturer's instructions shall be followed at all times
- Care: Clean with a soft, dry cloth. In case of larger stains, carefully rub with a slightly damp, non-abrasive sponge
- Avoid the risk of fire by not placing furniture near sources of ignition or hot items
- Do not jump on the bed

Deutsch

WICHTIG ! ZUM SPÄTEREN NACHSCHLAGEN AUFBEWAHREN: SORGFÄLTIG LESEN

- Muss von einem Erwachsenen zusammengebaut werden. Der Zusammenbau muss vor dem Gebrauch von einem Erwachsenen überprüft werden
- WARNUNG! Bewahren Sie alle Schrauben, Kleinteile und Plastikbeutel außerhalb der Reichweite von Kindern auf
- Kennzeichnen Sie vor dem Zusammenbau alle Teile richtig
- Benutzen Sie Ihren Artikel niemals, wenn Teile gebrochen sind oder fehlen
- Sollten Probleme auftreten, wenden Sie sich bitte an unseren Kundendienst
- Die Anweisungen des Herstellers sind stets zu befolgen
- Pflege: Mit einem weichen, trockenen Tuch reinigen. Bei größeren Flecken vorsichtig mit einem leicht feuchten, nicht scheuernden Schwamm abreiben. nicht scheuernden Schwamm
- Vermeiden Sie die Gefahr eines Brandes, indem Sie die Möbel nicht in der Nähe von Zündquellen oder heißen Gegenständen aufstellen
- Nicht auf das Bett springen

Français

IMPORTANT ! CONSERVER POUR RÉFÉRENCE ULTÉRIEURE : LIRE ATTENTIVEMENT

- Le montage doit être effectué par un adulte. Le montage doit être vérifié par un adulte avant Utilisation
- ATTENTION ! Tenir les vis, les petites pièces et les sachets en plastique hors de portée des enfants
- Identifiez correctement toutes les pièces avant de les assembler
- N'utilisez jamais votre article si l'une de ses pièces est cassée ou manquante
- En cas de problème, veuillez contacter notre service après-vente
- Les instructions du fabricant doivent être respectées à tout moment
- Entretien : nettoyer avec un chiffon doux et sec. En cas de taches plus importantes, frotter soigneusement avec une éponge non abrasive légèrement humide. légèrement humide et non Abrasive
- Évitez les risques d'incendie en ne plaçant pas les meubles à proximité de sources d'inflammation ou d'objets chauds
- Ne pas sauter sur le lit

Italiano

IMPORTANTE! CONSERVARE PER RIFERIMENTO FUTURO: LEGGERE ATTENTAMENTE

- Deve essere assemblato da un adulto. L'assemblaggio deve essere controllato da un adulto prima dell'uso
- **ATTENZIONE!** Tenere tutte le viti, le piccole parti e i sacchetti di plastica fuori dalla portata dei bambini
- Identificare correttamente tutte le parti prima dell'assemblaggio
- Non utilizzare mai l'articolo se alcune parti sono rotte o mancanti
- In caso di problemi, si prega di contattare il nostro Servizio Post Vendita
- Le istruzioni del produttore devono essere sempre seguite
- Cura: Pulire con un panno morbido e asciutto. In caso di macchie più estese, strofinare accuratamente con una spugna leggermente umida e nonspugna leggermente umida e non abrasiva
- Evitare il rischio di incendio, non collocando i mobili vicino a fonti di accensione o a oggetti caldi
- Non saltare sul letto

Español

¡ IMPORTANTE ! CONSERVELO PARA FUTURAS CONSULTAS: LEA ATENTAMENTE

- Debe ser montado por un adulto. El montaje debe ser comprobado por un adulto antes del uso
- ADVERTENCIA Mantenga todos los tornillos, piezas pequeñas y bolsas de plástico fuera del alcance de los niños.
- Identifique correctamente todas las piezas antes de montarlas
 - Nunca utilice su artículo si alguna de sus piezas está rota o falta
 - Si surge algún problema, póngase en contacto con nuestro Servicio Postventa
 - Las instrucciones del fabricante deben seguirse en todo momento
 - Cuidado: Limpiar con un paño suave y seco. En caso de manchas más grandes, frote cuidadosamente con una esponja no abrasiva ligeramente humedecida.
 - Evite el riesgo de incendio no colocando los muebles cerca de fuentes de ignición u objetos calientes.
 - No saltar sobre la cama.

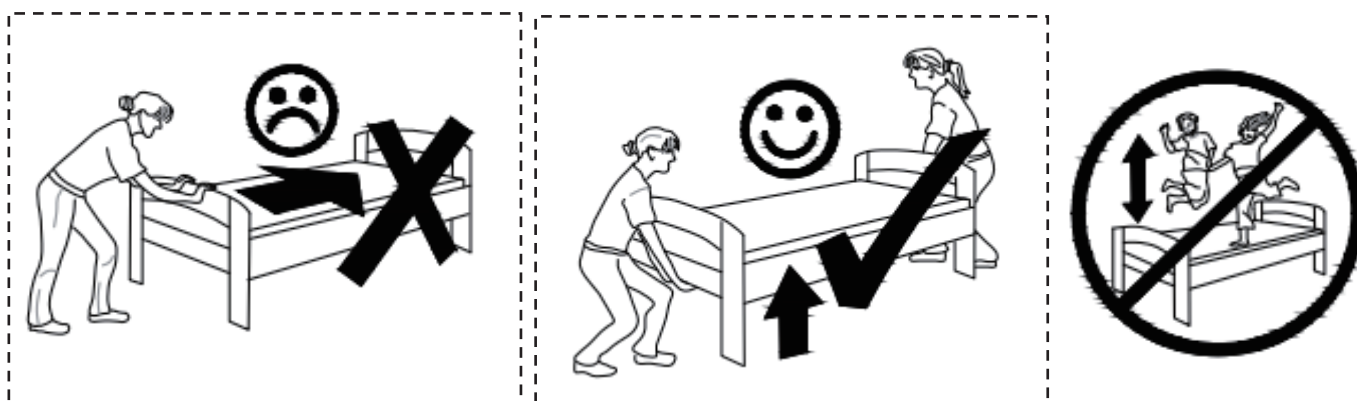

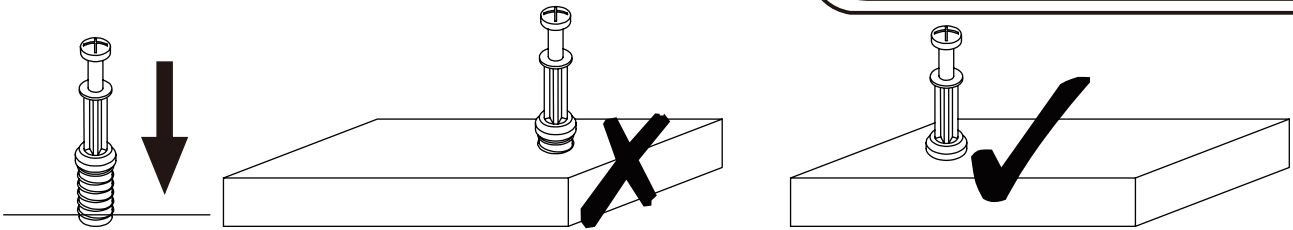

EN_QUICKFIT: Tighten quickfit until shoulder is flush with panel. Do not overtighten or undertighten.

FR_RACCORD RAPIDE: Faites serrer le raccord rapide jusqu'à ce que l'épaulement soit parfaitement encastré dans le panneau. Il ne faut ni trop serrer ni insuffisamment serrer.

ES_QUICKFIT: Apriete quickfit hasta que el hombro se descargue con el panel. NO lo sobreapriete ni lo apriete poco.

DE_QUICKFIT: Ziehen Sie den Quickfit fest, bis die Schulter mit der Platte bündig ist. Bitte nicht zu fest oder zu schwach anziehen.

IT_MONTAGGIO RAPIDO: Stringere il montaggio rapido fino a quando la spalla è a filo con il pannello, non stringere troppo o troppo poco.

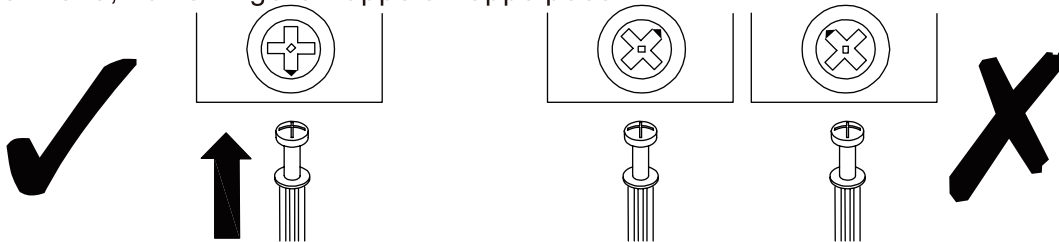

EN_CAM LOCK: When fitting cam lock, ensure starting position is correct before you insert connecting quickfit.

FR_SERRURE BATTEUSE: Avant d'insérer la serrure batteuse, veillez à la bonne orientation avant d'insérer le raccord rapide.

ES_CIERRE DE LA CÁMARA: Cuando instale el cierre de la cámara, asegúrese de que la posición de inicio es correcta antes de que inserte el quickfit conector.

DE_CAM-LOCK: Achten Sie bei der Montage des Cam-Locks auf die richtige Ausgangsposition, bevor Sie den Quickfit einsetzen.

IT_BLOCCAGGIO A CAMMA: Quando si monta il bloccaggio a camma, assicurarsi che la posizione iniziale sia corretta prima di inserire il montaggio rapido di collegamento.

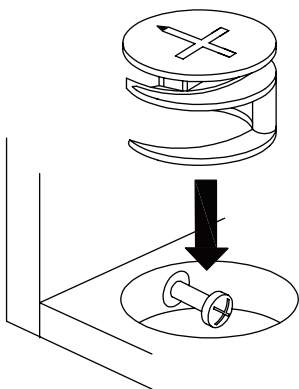

EN_Quickfit head should be in the centre of the cam lock when the two panels are joined.

Cam lock should be inserted before quickfit.

FR_Lorsque les deux panneaux sont assemblés, la tête du raccord rapide doit reposer au centre de la serrure batteuse. Il faut insérer la serrure batteuse avant le raccord rapide.

ES_El cabezal del quickfit debe estar en el centro del cierre de la cámara cuando se unan los dos paneles.

Se debe insertar el cierre de la cámara antes que el quickfit.

DE_Der Quickfit-Kopf sollte sich in der Mitte des Cam-Locks befinden, wenn die beiden Platten zusammengefügt sind.

Der Cam-Lock sollte vor dem Quickfit eingesetzt werden.

IT_La testa del montaggio rapido deve trovarsi al centro del bloccaggio a camma quando i due pannelli sono uniti.

Il Bloccaggio a Camma deve essere inserito prima del montaggio rapido.

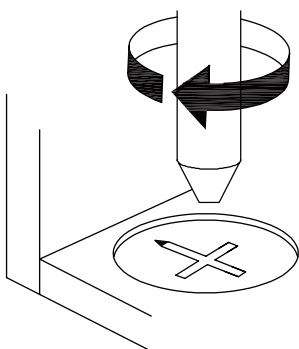

EN_Turn cam lock clockwise to tighten.

FR_Faites tourner la serrure batteuse dans le sens des aiguilles d'une montre pour la resserrer.

ES_Gire el cierre de la cámara en sentido horario para apretarlo.

DE_Drehen Sie den Cam-Lock im Uhrzeigersinn, um ihn festzuziehen.

IT_Ruotare il bloccaggio a camma in senso orario per stringere.

DE: Vor dem Einbau die Schrauben in die Löcher stecken und festziehen, aber nicht bis 100%, 70% bis 80% anziehen reicht aus. Schließlich, nachdem alle Schrauben installiert sind, ziehen Sie alle Schrauben auf 100%. Wenn Sie auf diese Probleme stoßen, wie z. B. Fehlausrichtung der Löcher oder Unfähigkeit, bestimmte Teile zu installieren, überprüfen Sie bitte, ob die Schrauben korrekt verwendet werden und passen Sie die Dichtigkeit der Schrauben an.

UK: Before installation, insert the screws into the holes and tighten them, but do not tighten them to 100%, 70% to 80% is sufficient. Finally, after all screws are installed, tighten all screws to 100%. If you encounter these issues, such as if the holes cannot be aligned or some parts cannot be installed, please check if the screws are used correctly and adjust the tightness of the screws.

FR: Insérer la vis dans le trou avant la fin de l'assemblage, serrer la vis, mais ne pas serrer à 100%, 70% ~ 80% est correct. Enfin, une fois que toutes les vis sont bien serrées, toutes les vis sont serrées à 100%. Si vous rencontrez ces problèmes, par exemple si les trous ne sont pas alignés ou si certaines pièces ne peuvent pas être montées, vérifiez que les vis sont utilisées correctement et Ajustez leur serrage.

Detailansicht

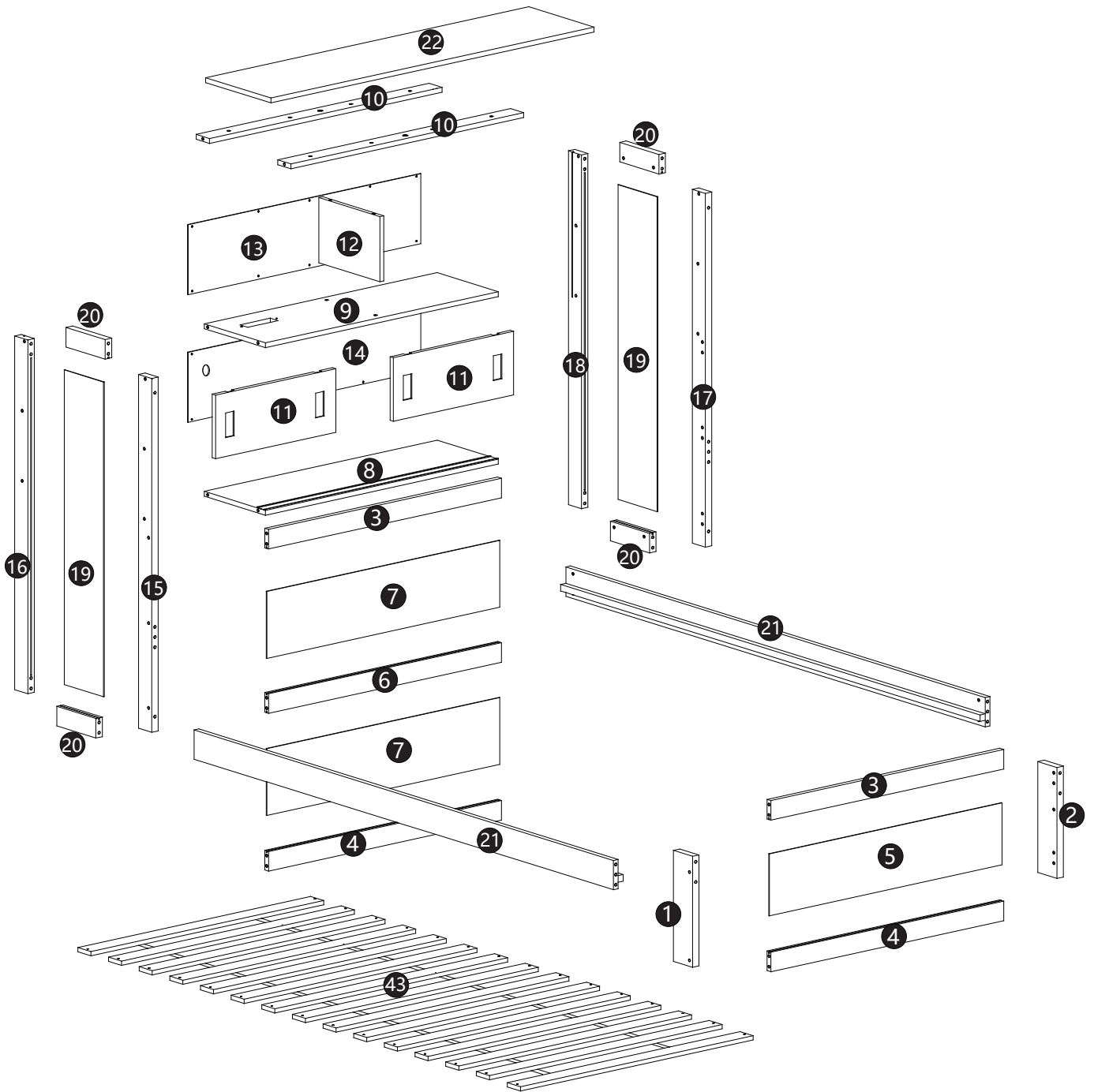

Detailansicht

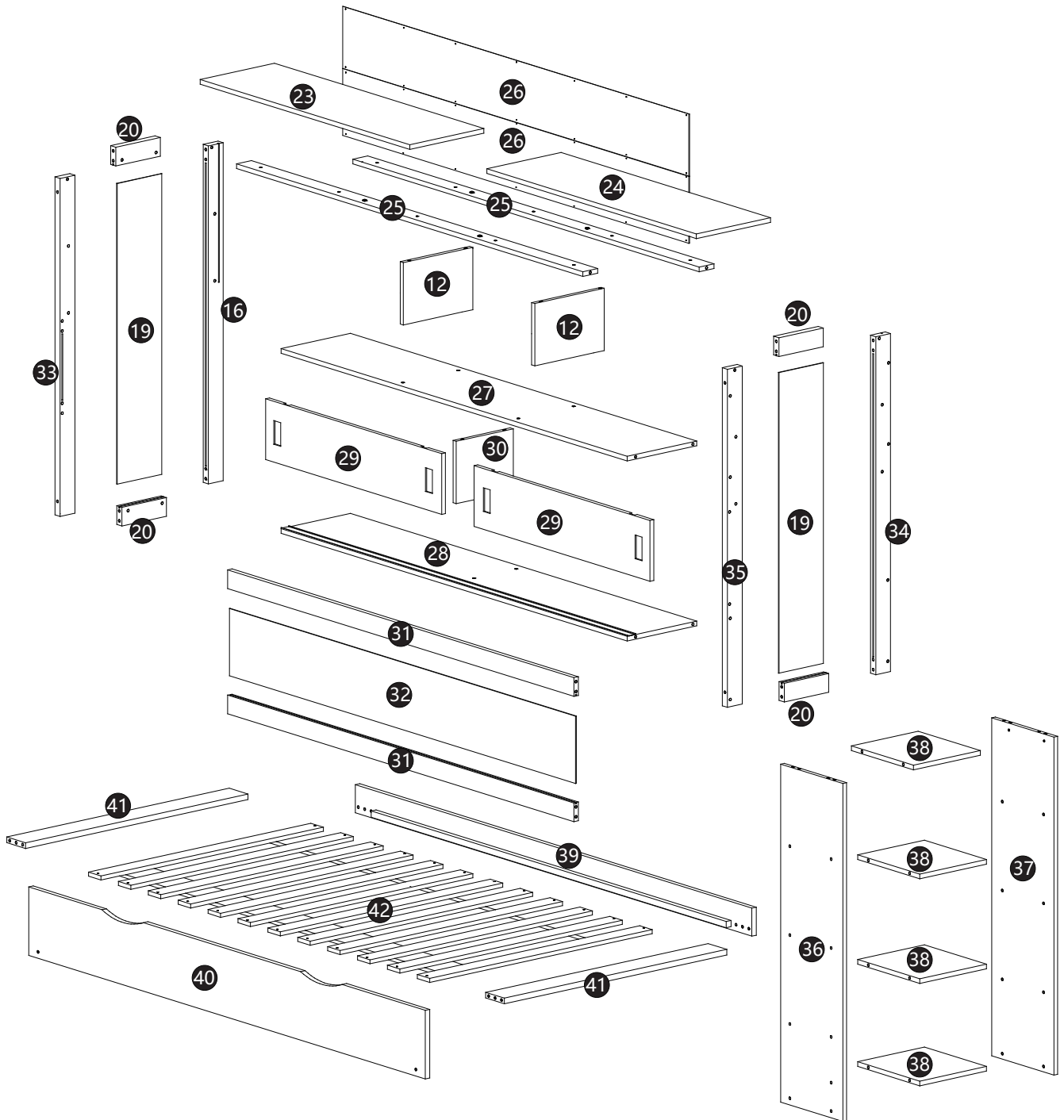

N636P211133

① x 1



② x 1



⑧ x 1



⑨ x 1

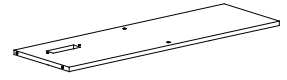

⑫ x 3

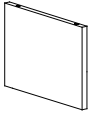

⑮ x 1

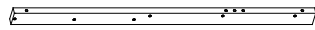

⑰ x 1

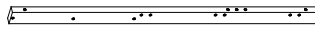

⑱ x 1



⑳ x 8



㉓ x 1

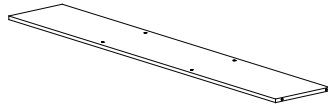

㉔ x 1

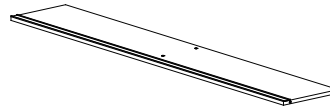

㉖ x 1

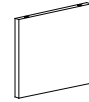

㉘ x 4

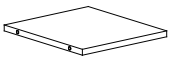

N636P211134

5 x 1

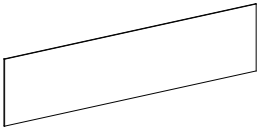

6 x 1



7 x 2

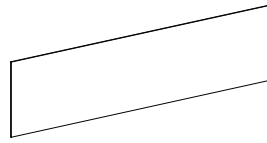

10 x 2

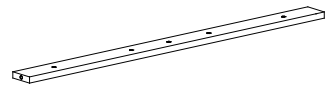

11 x 2

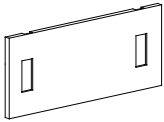

13 x 1

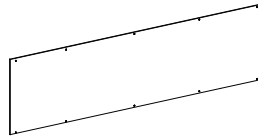

14 x 1

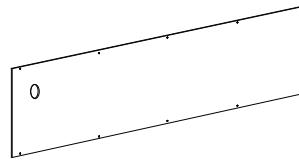

19 x 4

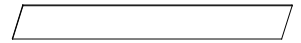

21 x 2

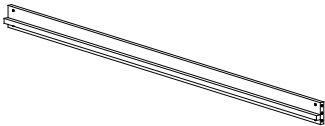

25 x 2

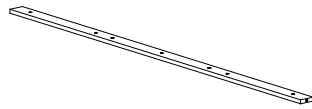

26 x 2

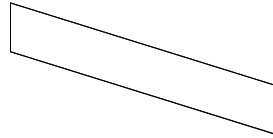

31 x 2

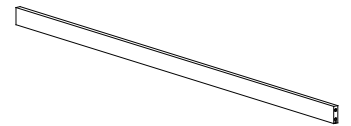

32 x 1

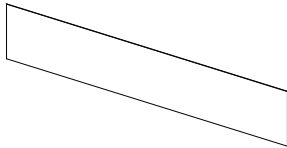

39 x 1

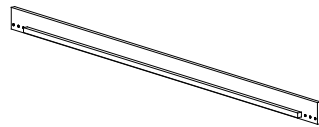

40 x 1

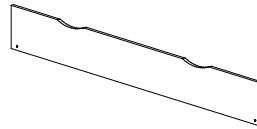

41 x 2

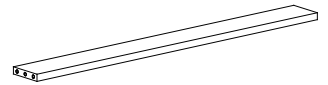

N636P211135

3 x 2

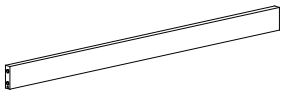

4 x 2



29 x 2

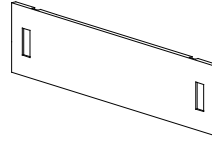

42 x 1

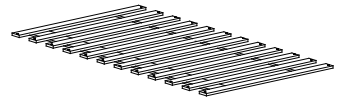

43 x 1

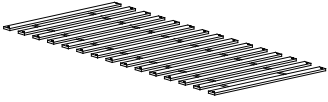

N636P211136

16 x 2



22 x 1

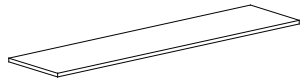

23 x 1

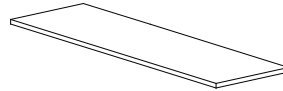

24 x 1

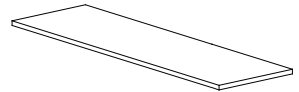

33 x 1

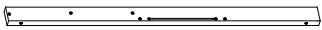

34 x 1



35 x 1





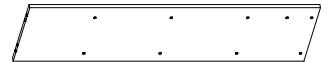



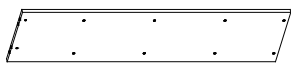









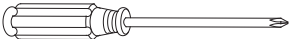

36 x 1



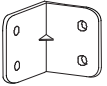

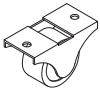
37 x 1

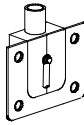
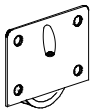
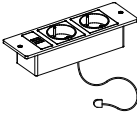

N636P211136



A  M6*60mm (18pcs)	B  M6*100mm(20pcs)	C  Φ10*13mm (42pcs)
D  Φ8*30mm (46pcs)	E  Φ4*30mm (54pcs)	F  M4 (2pcs)
G  (1pc)	H  (8pcs)	J  (8pcs)
K  M6*130mm (4pcs)	L  Φ3*14mm (90pcs)	M  Φ4*25mm (18pcs)
N  (4pcs)	P  M5*40mm (60pcs)	Q  M3 (1pc)
R  (4pcs)	S  M6*30mm (1pc)	T  (8pcs)
U  (8pcs)	V  (1pc)	W  Φ3.5*20mm(48pcs)
X  M6*20mm (1pc)		

A		B		K	
M6*60mm		M6*100mm		M6*130mm	

DE:Bitte beachten Sie, dass die Formen der Schrauben A und B und K ähnlich sind. Bitte installieren Sie entsprechend der Anleitung und unterscheiden Sie sie!

UK:Please note that the shapes of screws A and B and K are similar. Please install according to the instructions and distinguish them!



FR:Notez que les vis A et B et K ont des formes similaires. Veuillez les installer en suivant les instructions pour les séparer!

F		Q	
M4		M3	

DE:Bitte beachten Sie, dass die Formen der Schrauben F und Q ähnlich sind. Bitte installieren Sie entsprechend der Anleitung und unterscheiden Sie sie!

UK:Please note that the shapes of screws F and Q are similar. Please install according to the instructions and distinguish them!

FR:Notez que les vis F et Q ont des formes similaires. Veuillez les installer en suivant les instructions pour les séparer!





E		L		M	
Φ4*30mm		Φ3*14mm		Φ4*25mm	

DE:Bitte beachten Sie, dass die Formen der Schrauben E und L und M ähnlich sind. Bitte installieren Sie entsprechend der Anleitung und unterscheiden Sie sie!





UK:Please note that the shapes of screws E and L and M are similar. Please install according to the instructions and distinguish them!

FR:Notez que les vis E et L et M ont des formes similaires. Veuillez les installer en suivant les instructions pour les séparer!

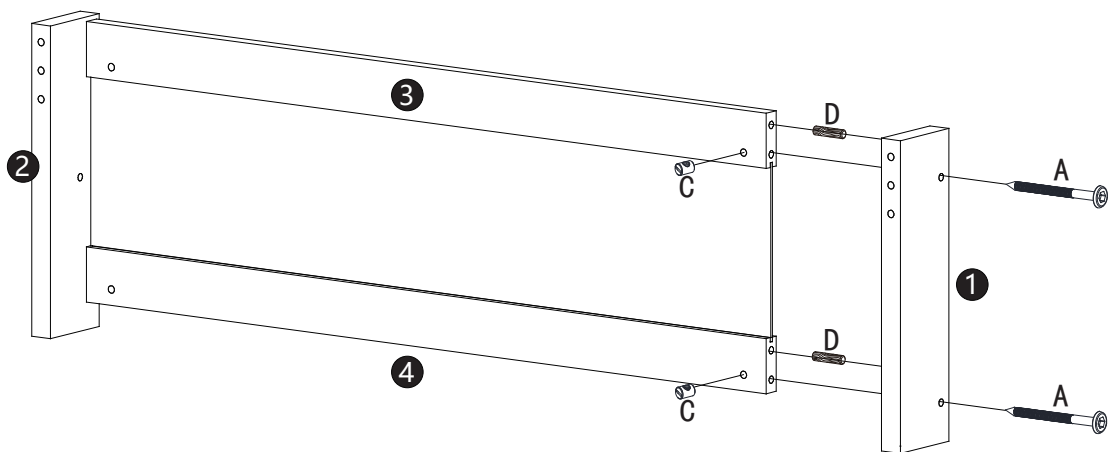
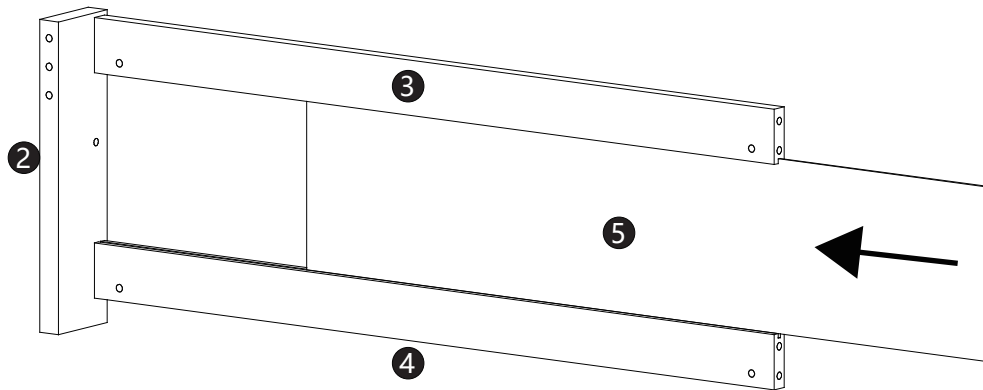
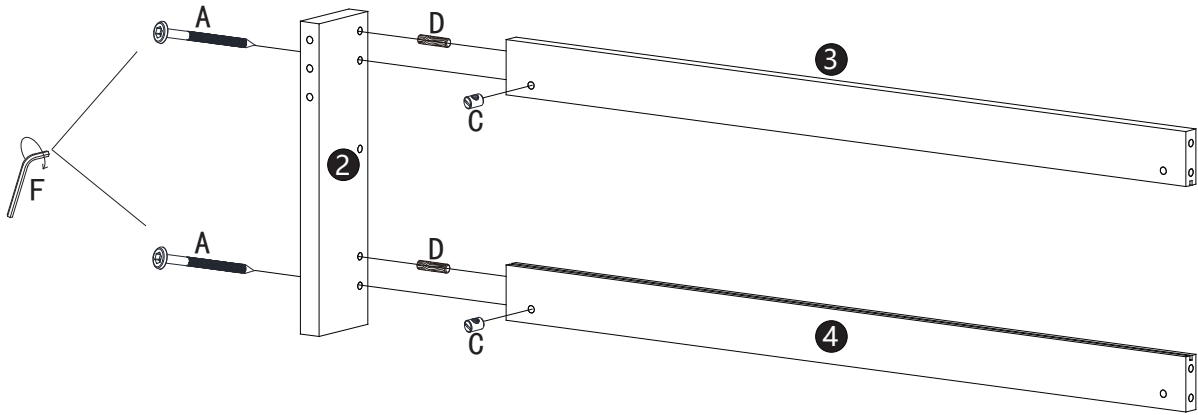



SCHRITT 1:

A		C		D		F	
4PCS		4PCS		4PCS		1PC	







A		B		K	
M6*60mm (4pcs)		M6*100mm		M6*130mm	
F		Q			
M4 (1pc)			M3		

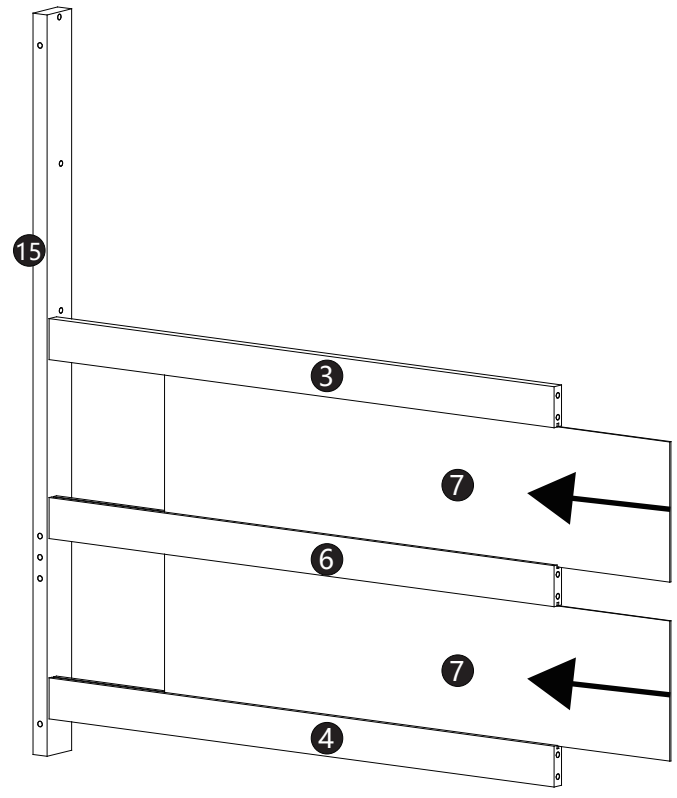
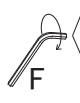
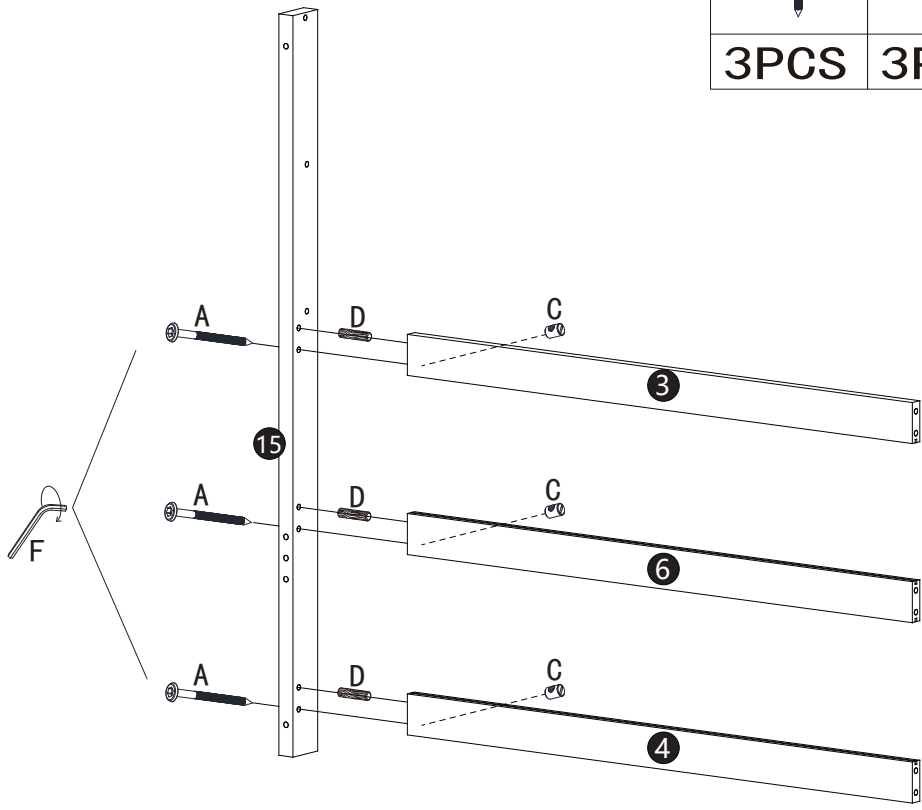





SCHRITT 2:

A		C		D		F	
3PCS		3PCS		3PCS		1PC	







A		F		Q	
M6*60mm (3pcs)		M4 (1pc)		M3	
B		K			
M6*100mm		M6*130mm			

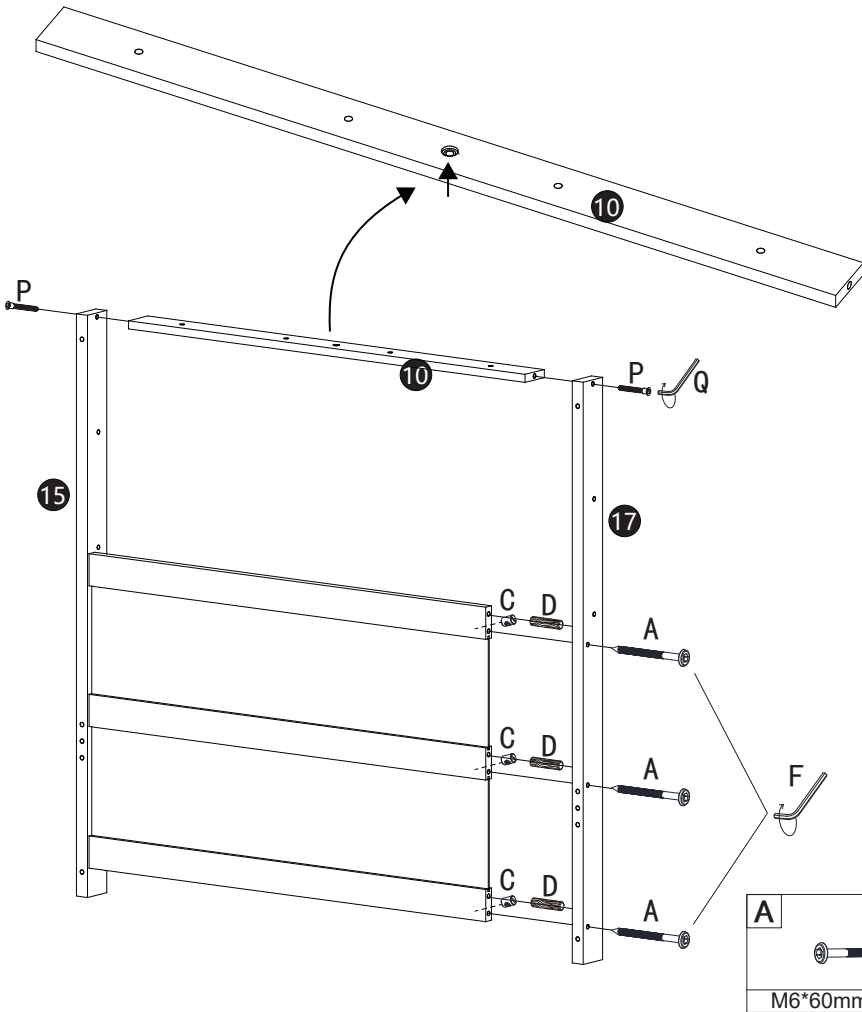



SCHRITT 3:

A		C		D	
	3PCS		3PCS		3PCS
F		P		Q	
	1PC		2PCS		1PC







F		Q	
	M4(1pc)		M3
A		K	
	M6*60mm (3pcs)		M6*130mm
		B	
			M6*100mm

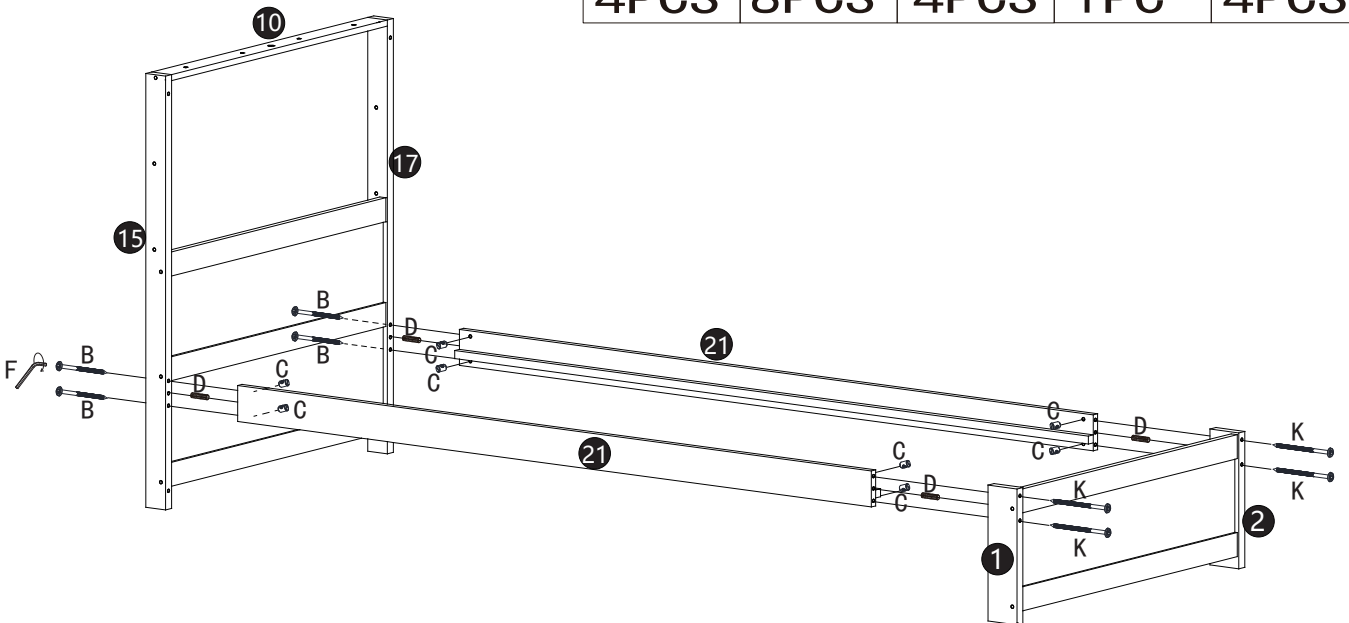



SCHRITT 4:

B		C		D		F		K	
	4PCS		8PCS		4PCS		1PC		4PCS





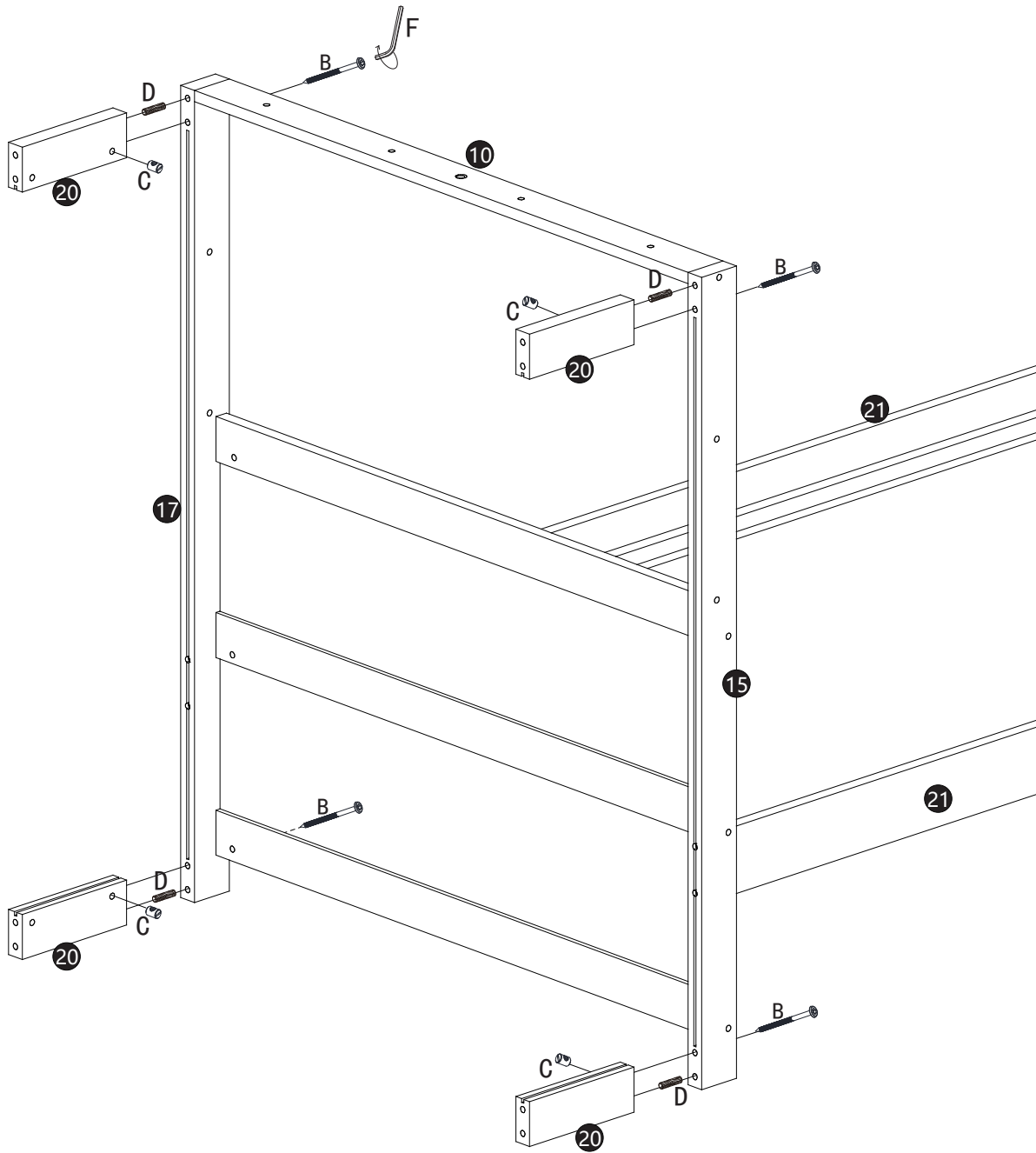

F		Q	
	M4(1pc)		M3
B		K	
	M6*100mm(4pcs)		M6*130mm(4pcs)
		A	
			M6*60mm

SCHRITT 5:

B		C		D		F	
4PCS		4PCS		4PCS		1PC	





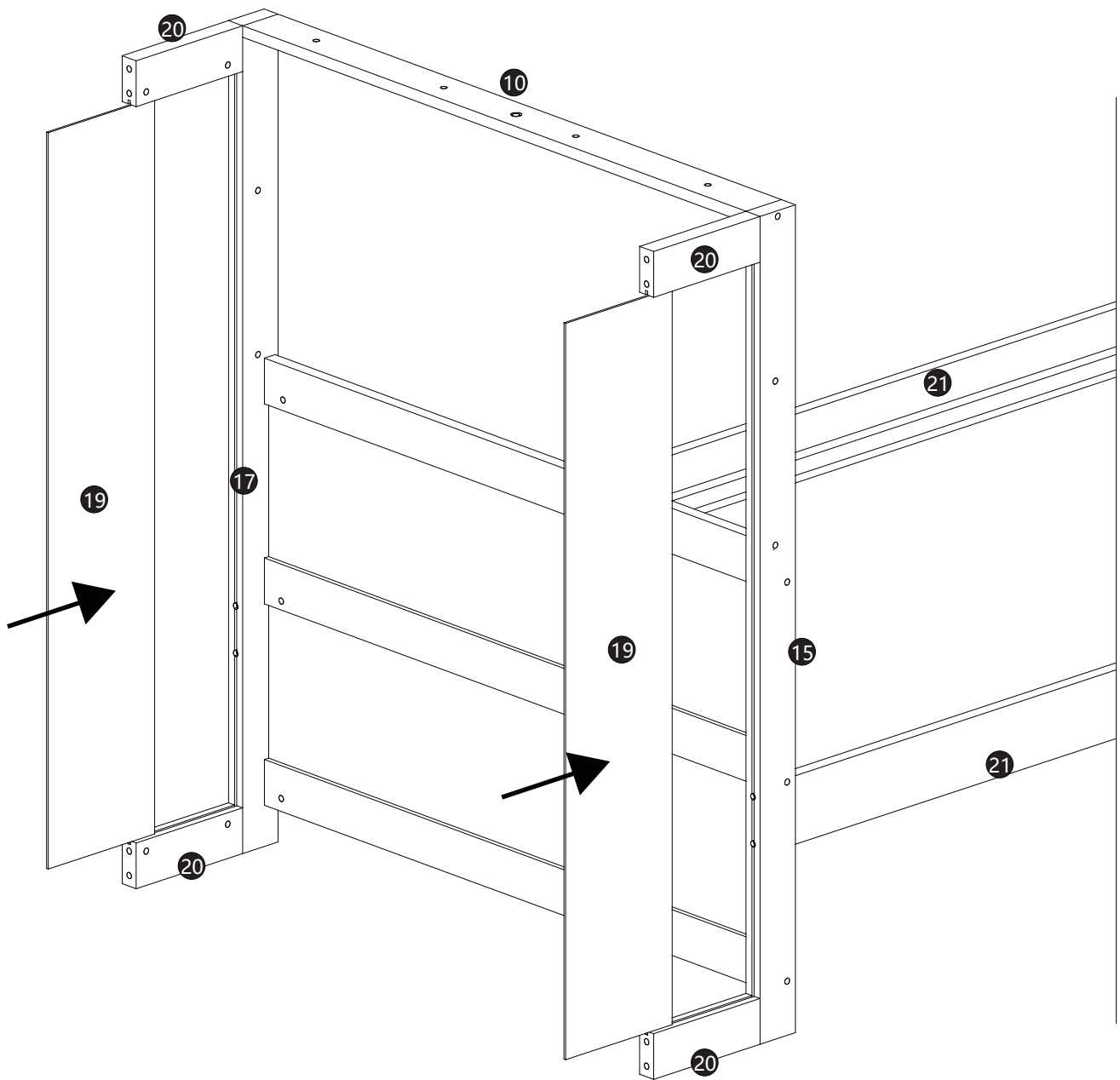

B		K		A	
M6*100mm(4pcs)		M6*130mm		M6*60mm	
		F		Q	
		M4(1pc)		M3	





SCHRITT 6:

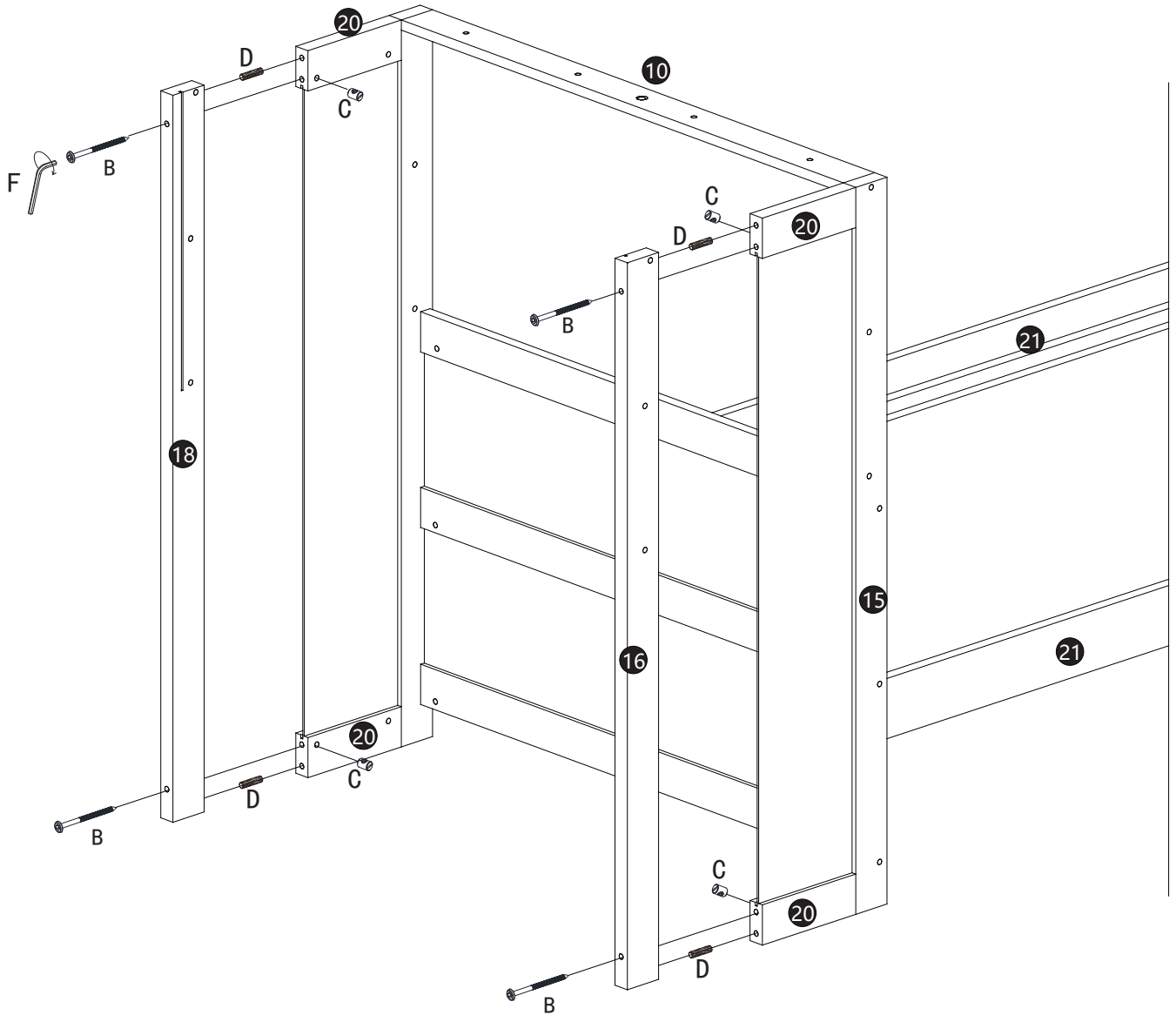

SCHRITT 7:

B 	C 	D 	F 
4PCS	4PCS	4PCS	1PC





B 	F 	Q 
M6*100mm(4pcs)	M4(1pc)	M3
K 	A 	
M6*130mm	M6*60mm	

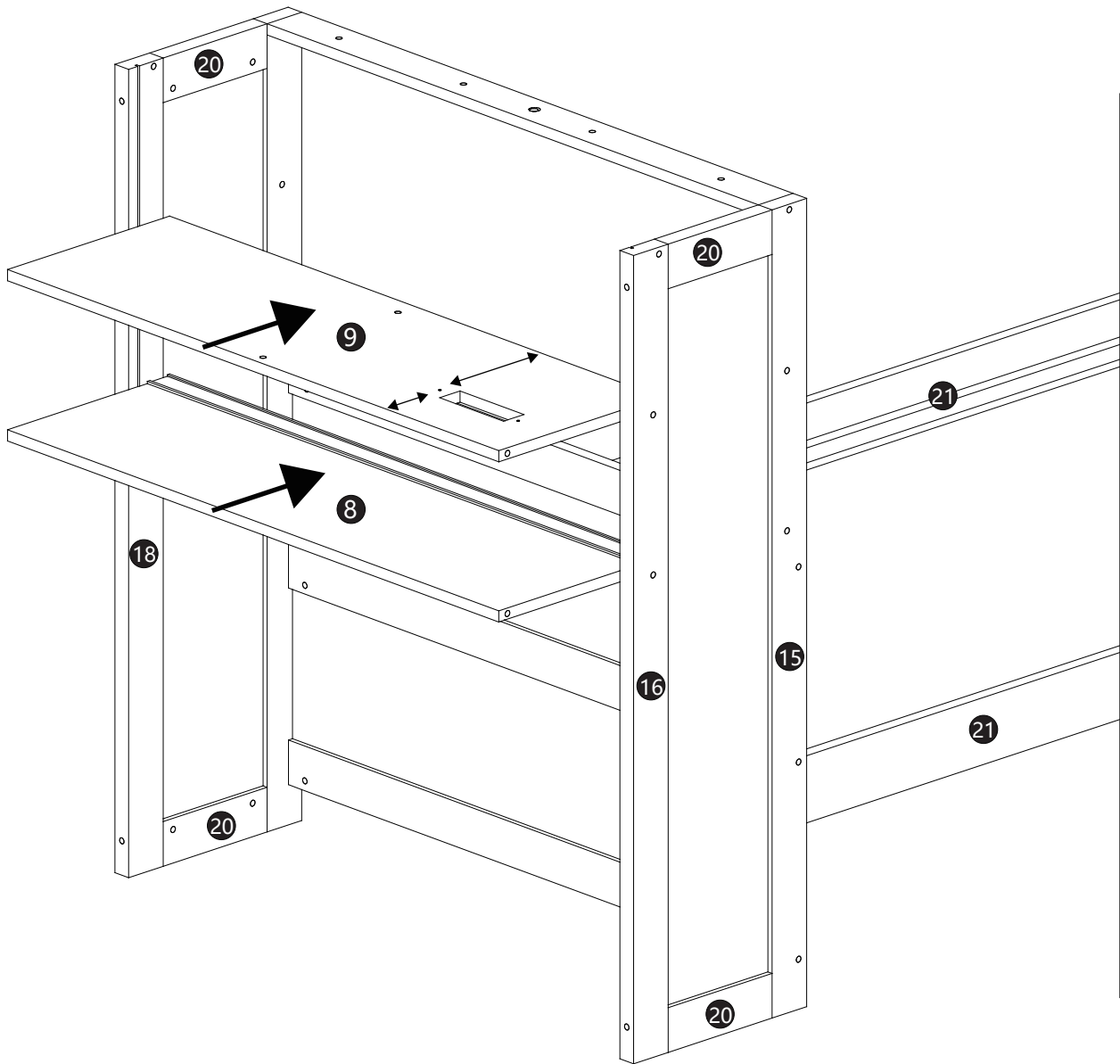

SCHRITT 8:



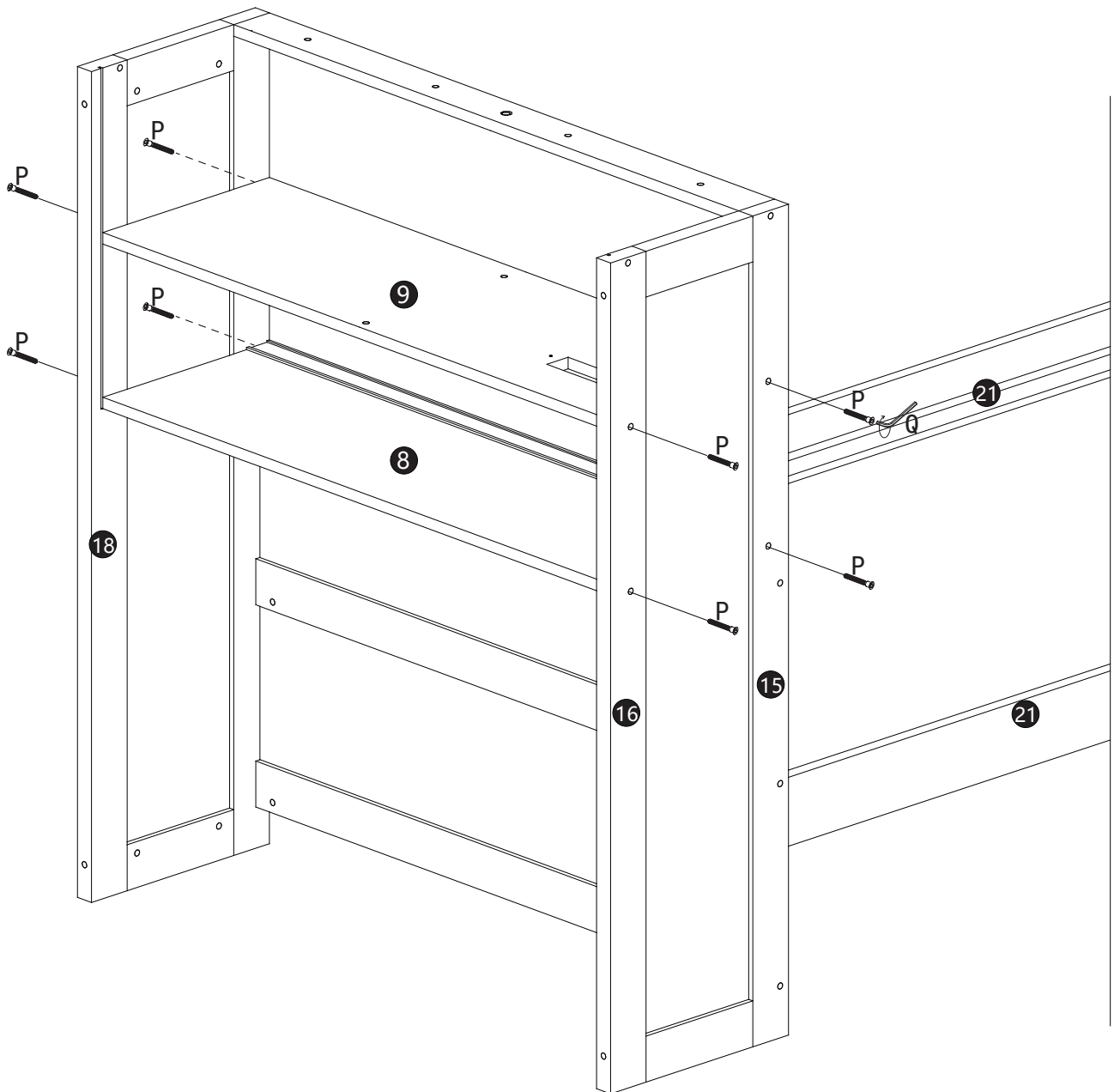

SCHRITT 9:

P		Q	
8PCS		1PC	





Q		F	
M3(1pc)		M4	

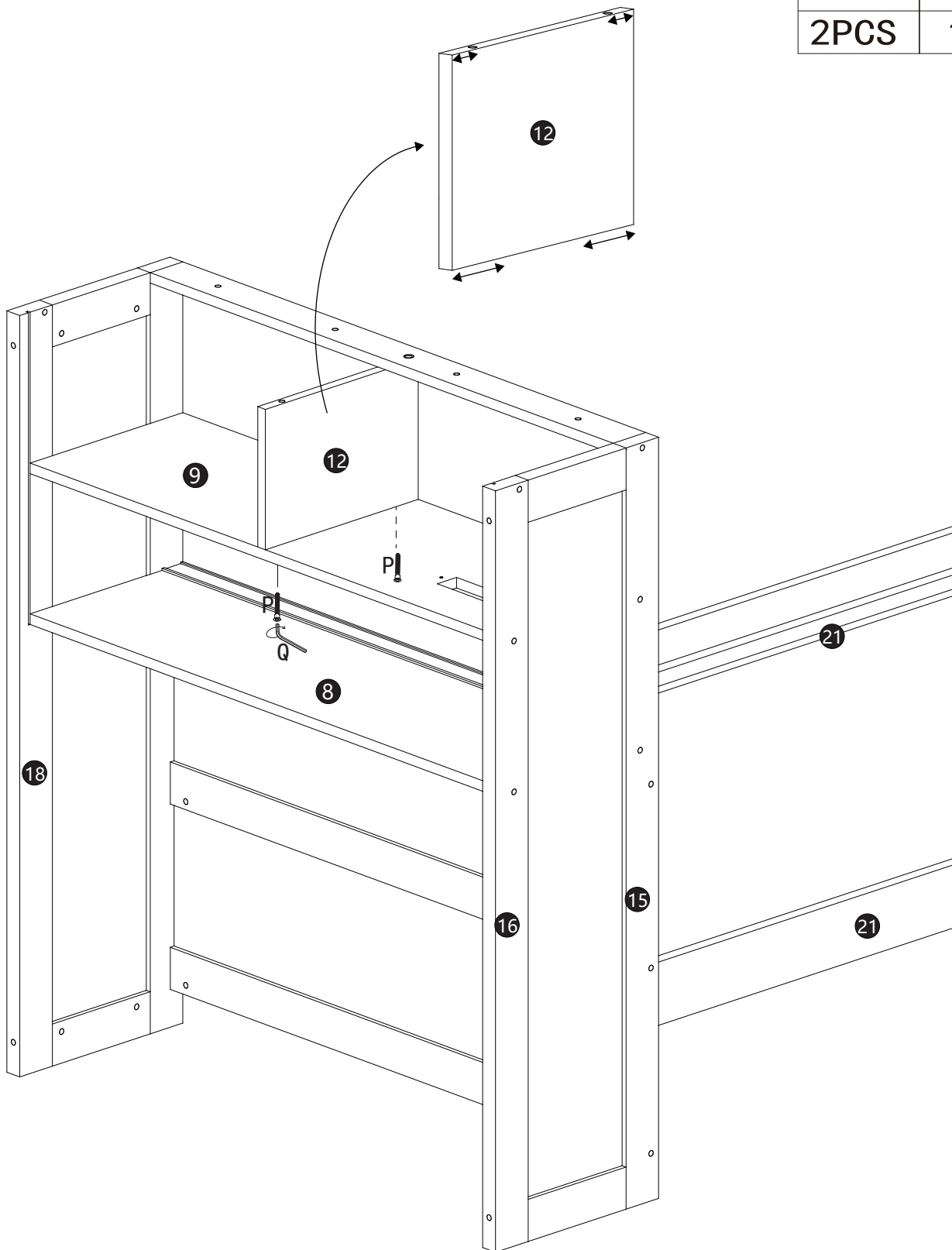

SCHRITT 10:

P		Q	
2PCS		1PC	





Q		F	
M3(1pc)		M4	

SCHRITT 11:

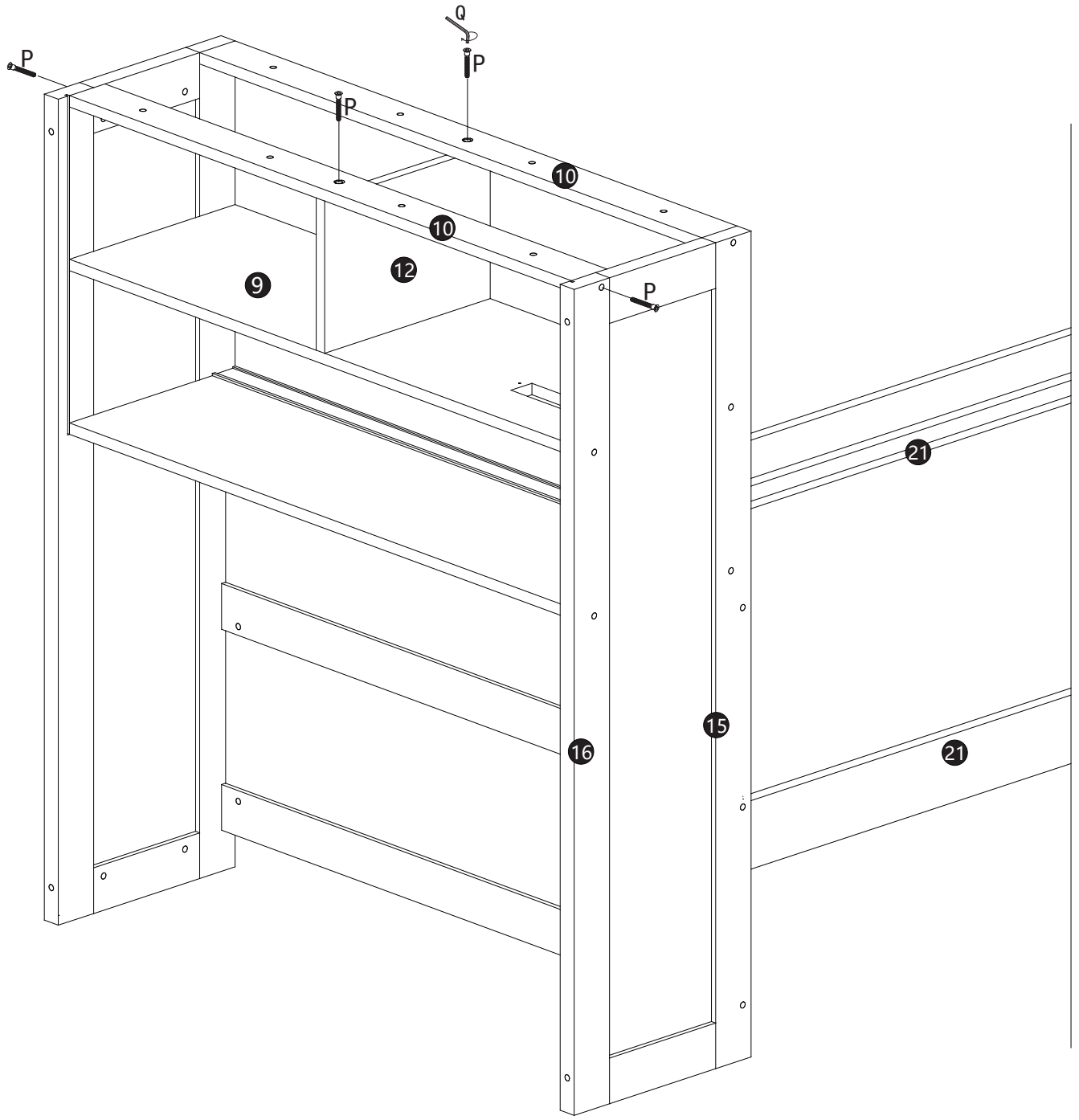
P		Q	
4PCS		1PC	





Q		F	
M3(1pc)		M4	

SCHRITT 12:

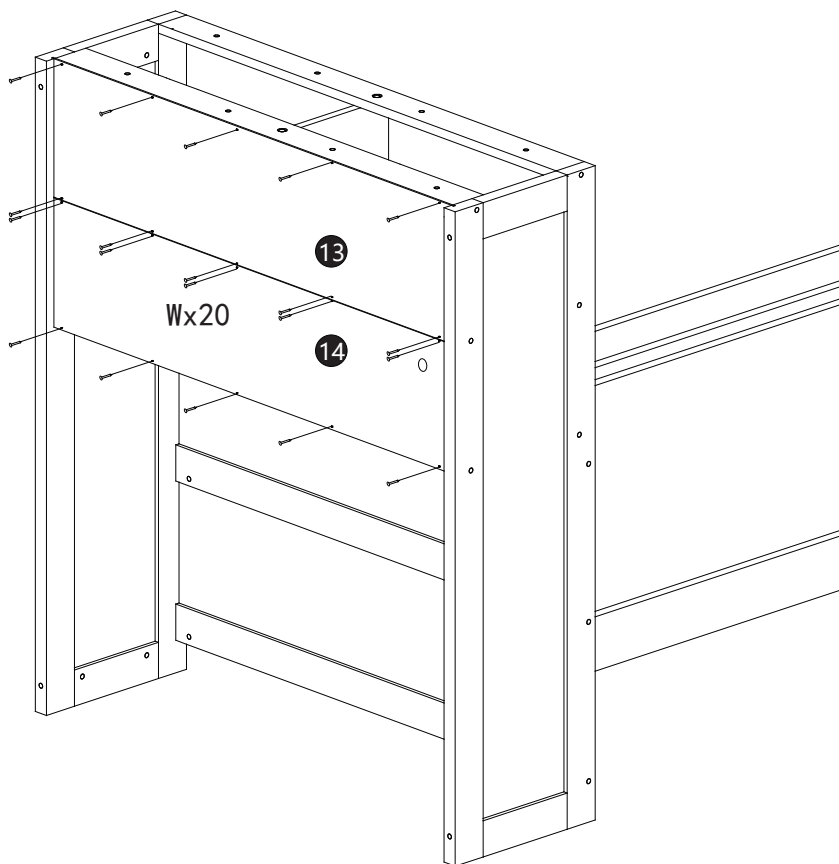
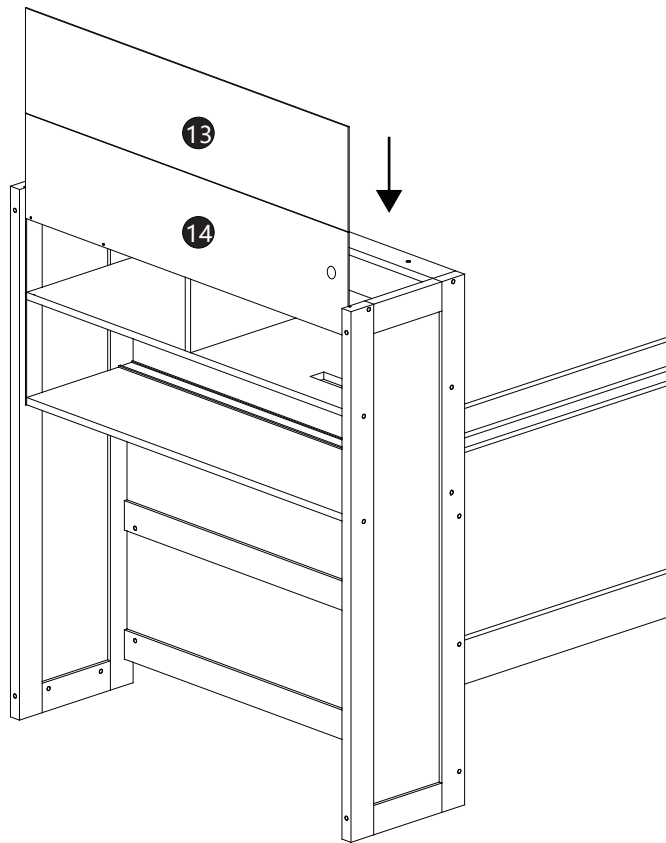

W	
20PCS	





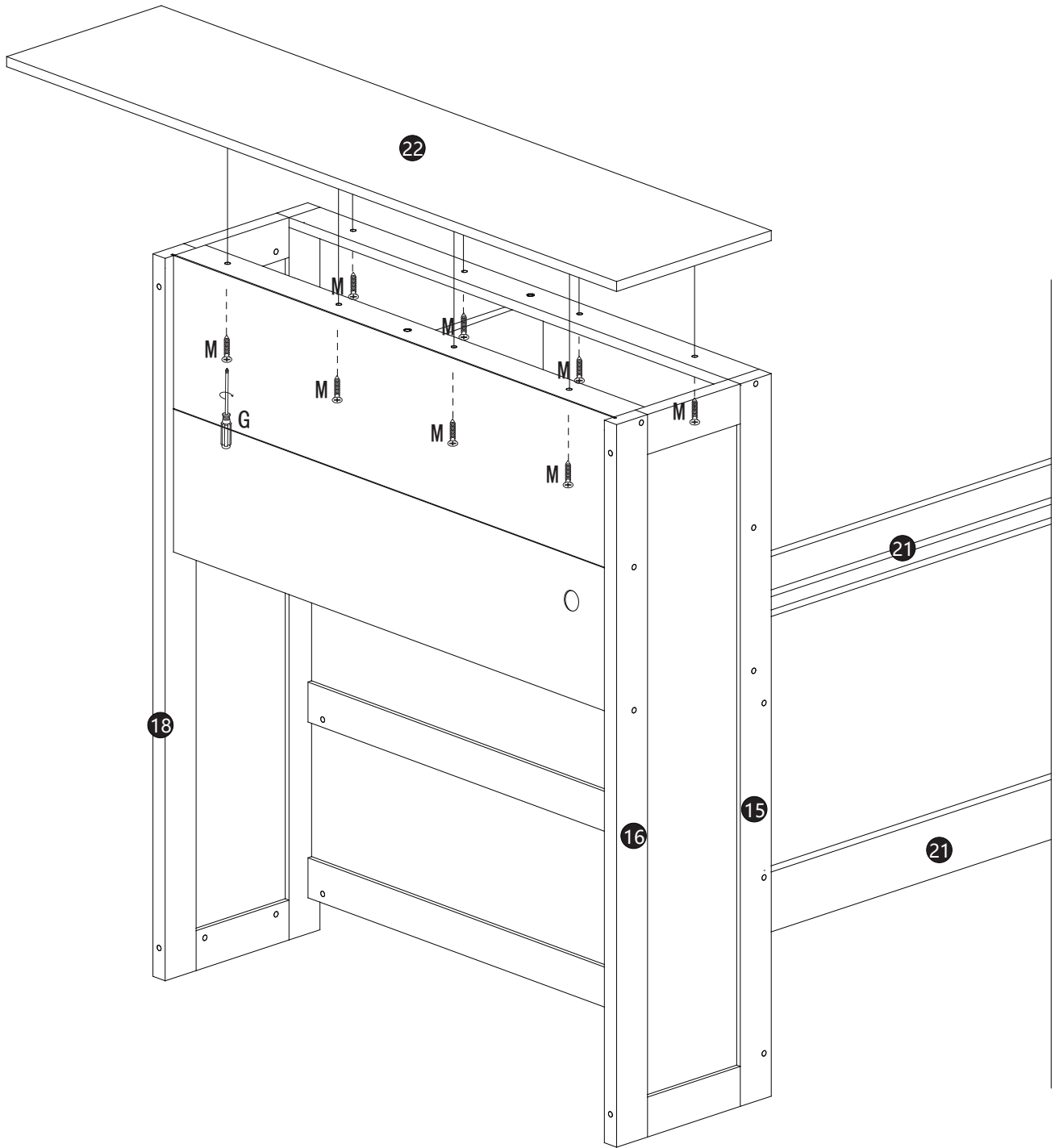

SCHRITT 13:

G		M	
	1PC		8PCS



M		E		L	
	Φ4*25mm (8pcs)		Φ4*30mm		Φ3*14mm



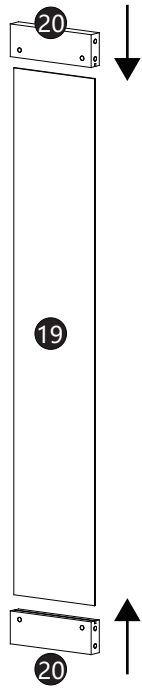

SCHRITT 14:

B 	C 	D 	F 
8PCS	8PCS	8PCS	1PC

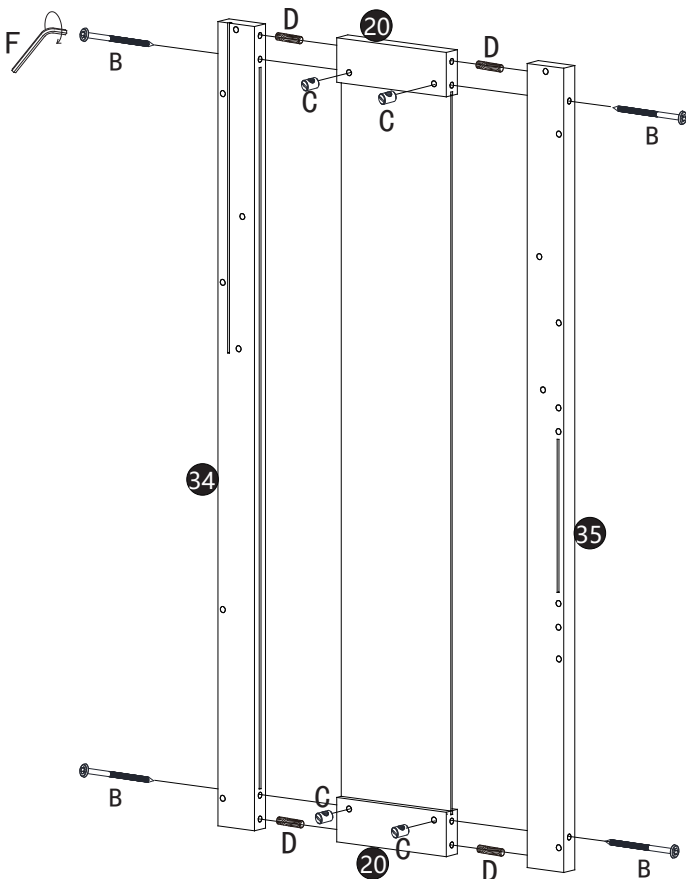
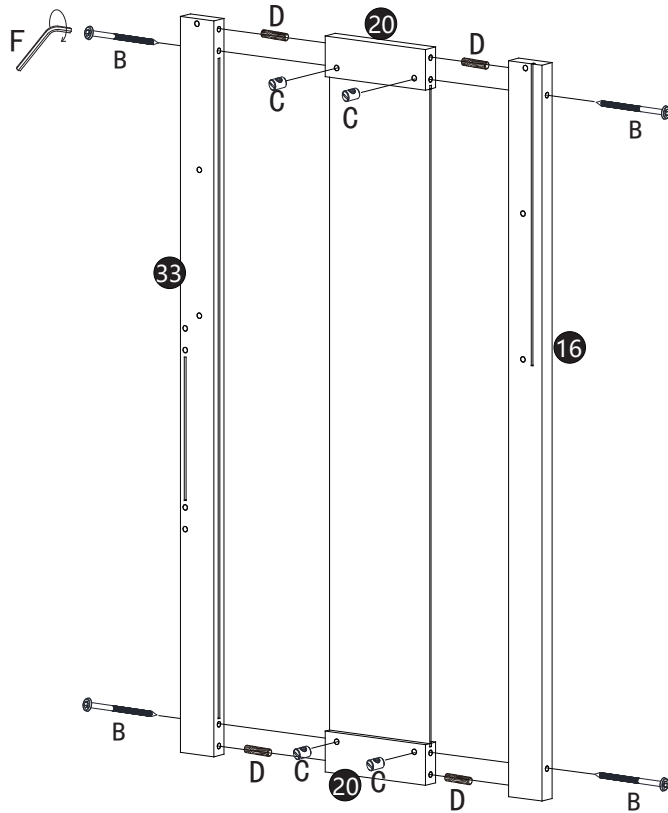





x2







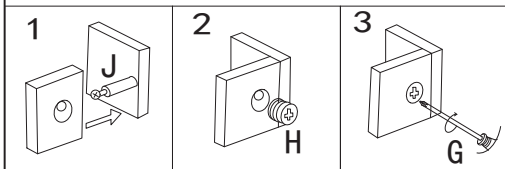
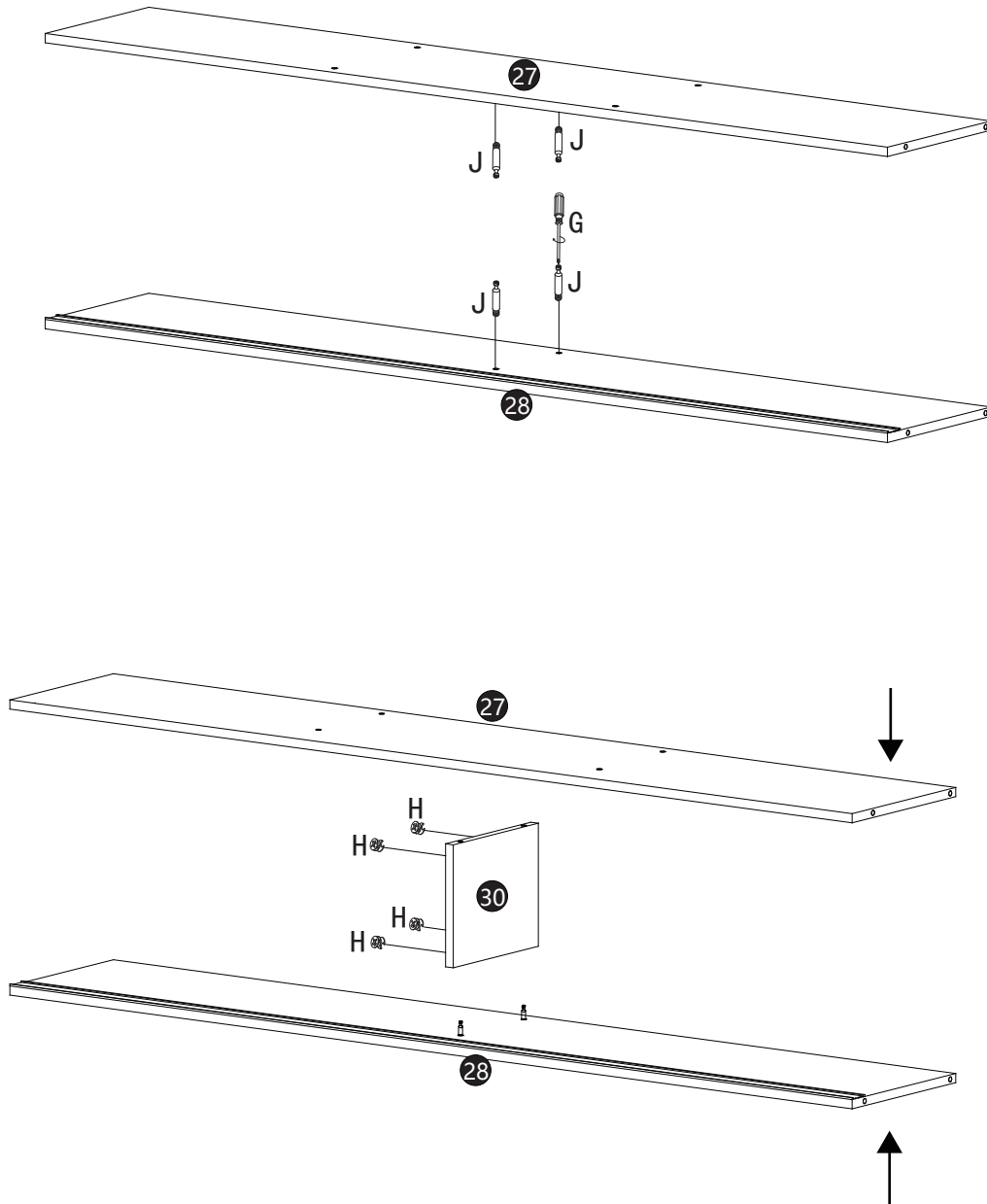

B 	F 	Q 
M6*100mm(8pcs)	M4(1pc)	M3
K 	A 	
M6*130mm	M6*60mm	

SCHRITT 15:



G		J		H	
					
	1PC		4PCS		4PCS



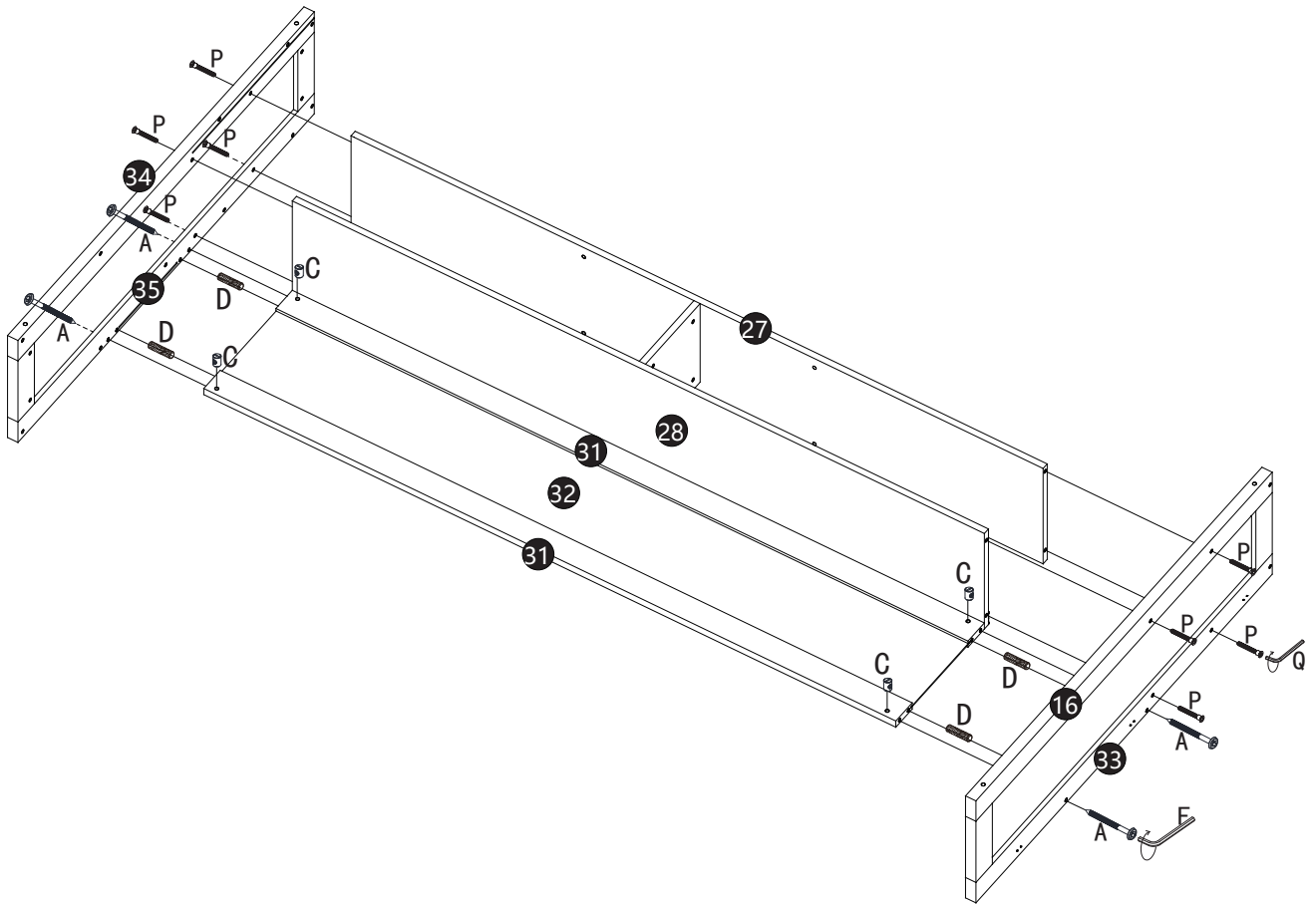
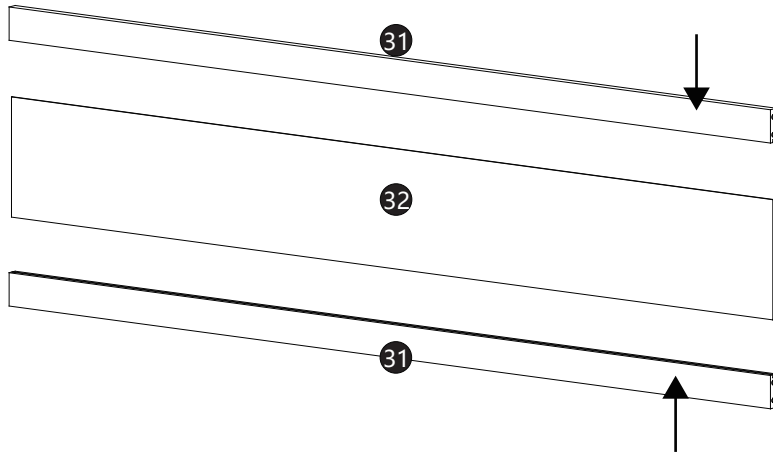

SCHRITT 16:

A		C		D		F		P		Q	
4PCS		4PCS		4PCS		1PC		8PCS		1PC	





A		B		K	
M6*60mm (4pcs)		M6*100mm		M6*130mm	

SCHRITT 17:

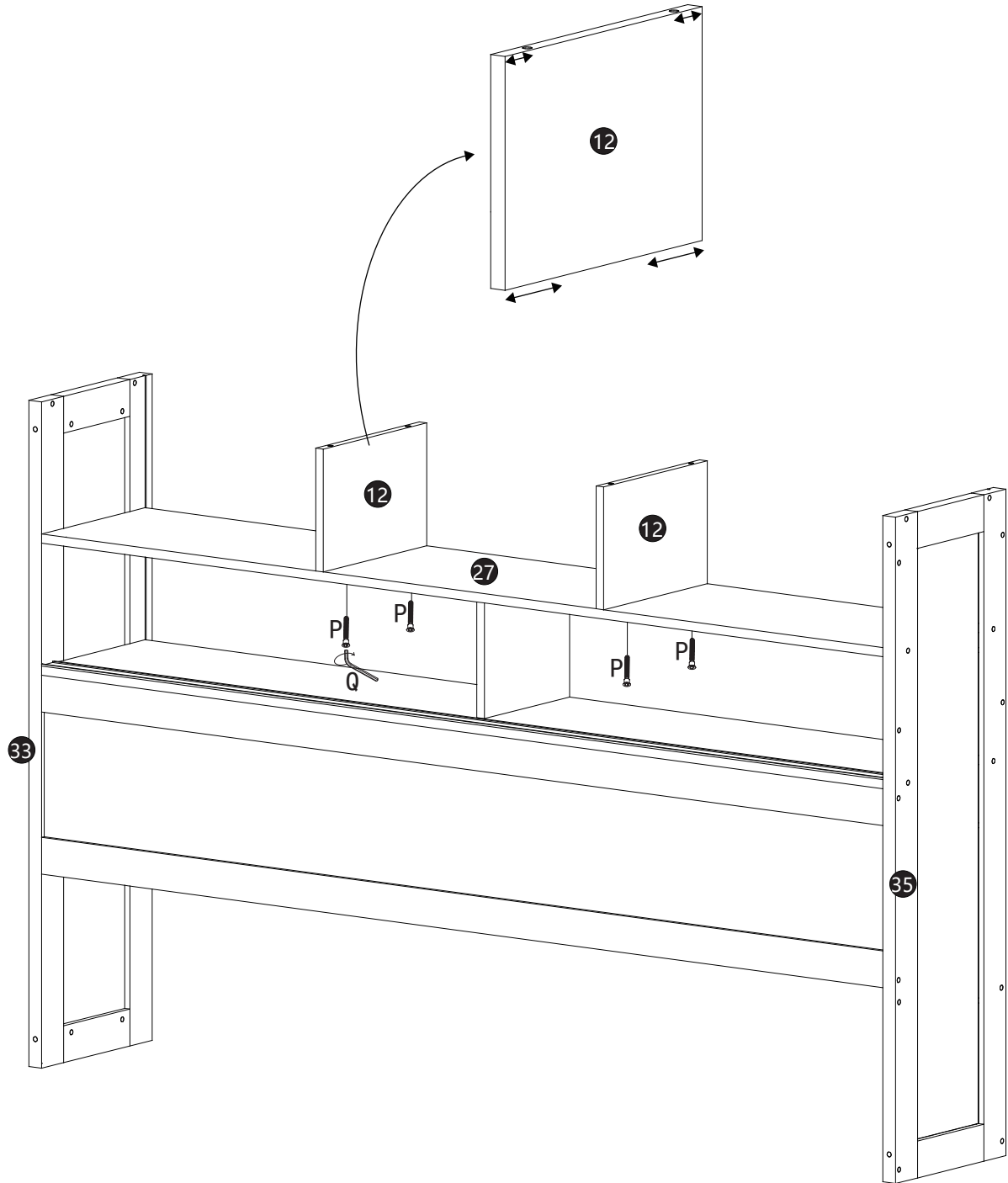
P		Q	
4PCS		1PC	



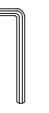

Q		F	
	M3(1pc)		M4

SCHRITT 18:

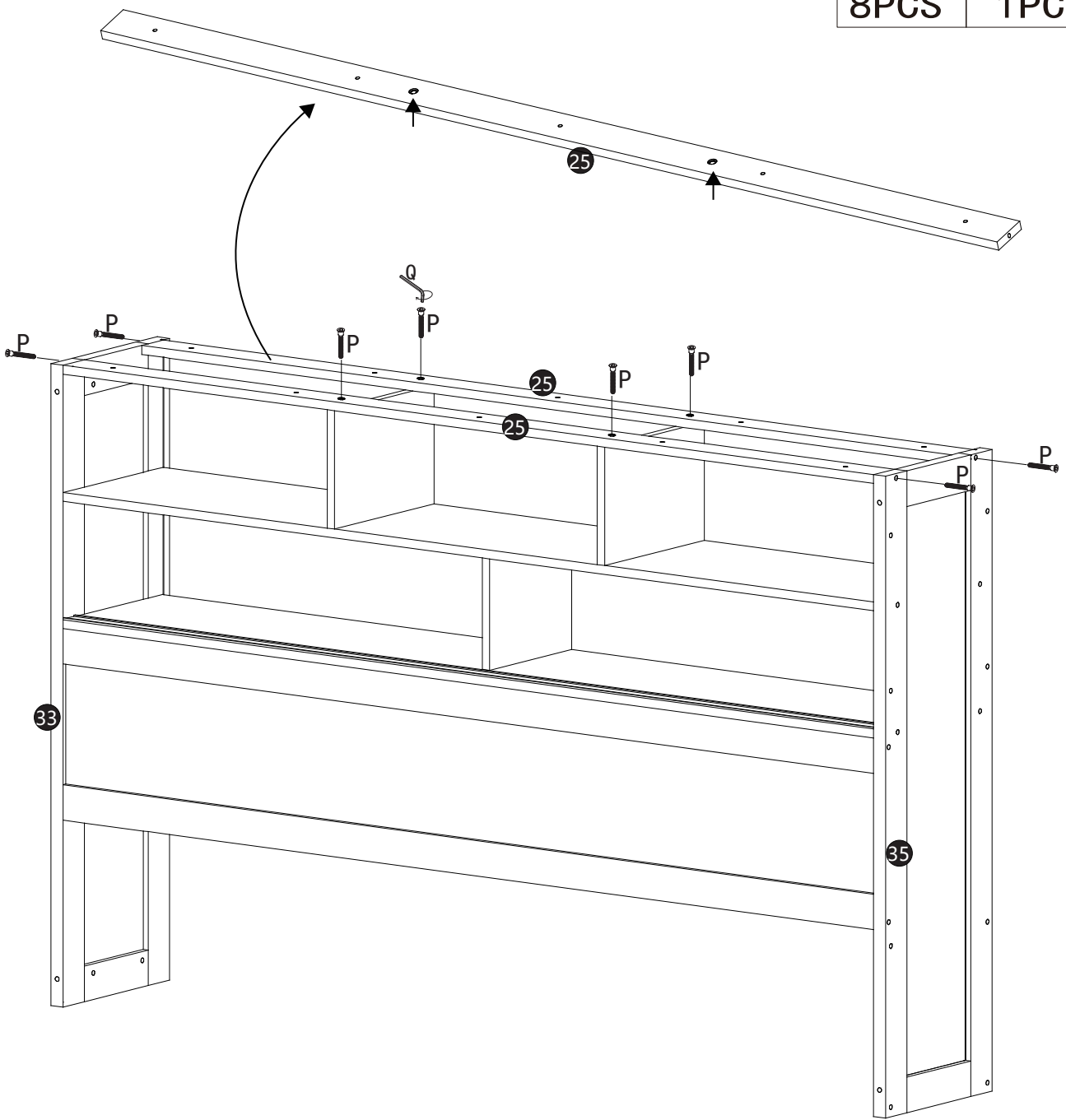
P		Q	
8PCS		1PC	



Q		F	
M3(1pc)		M4	

SCHRITT 19:

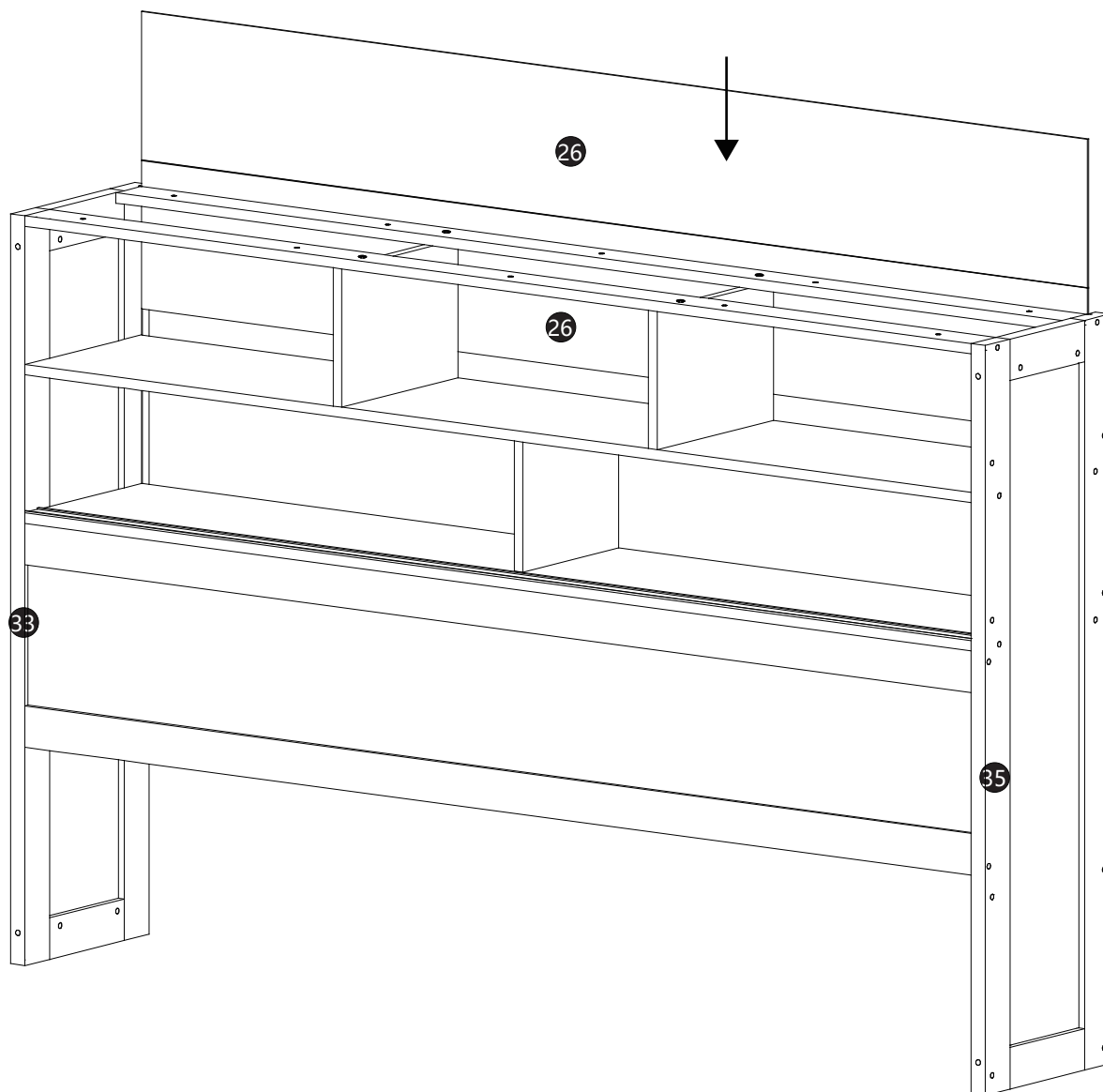

SCHRITT 20:

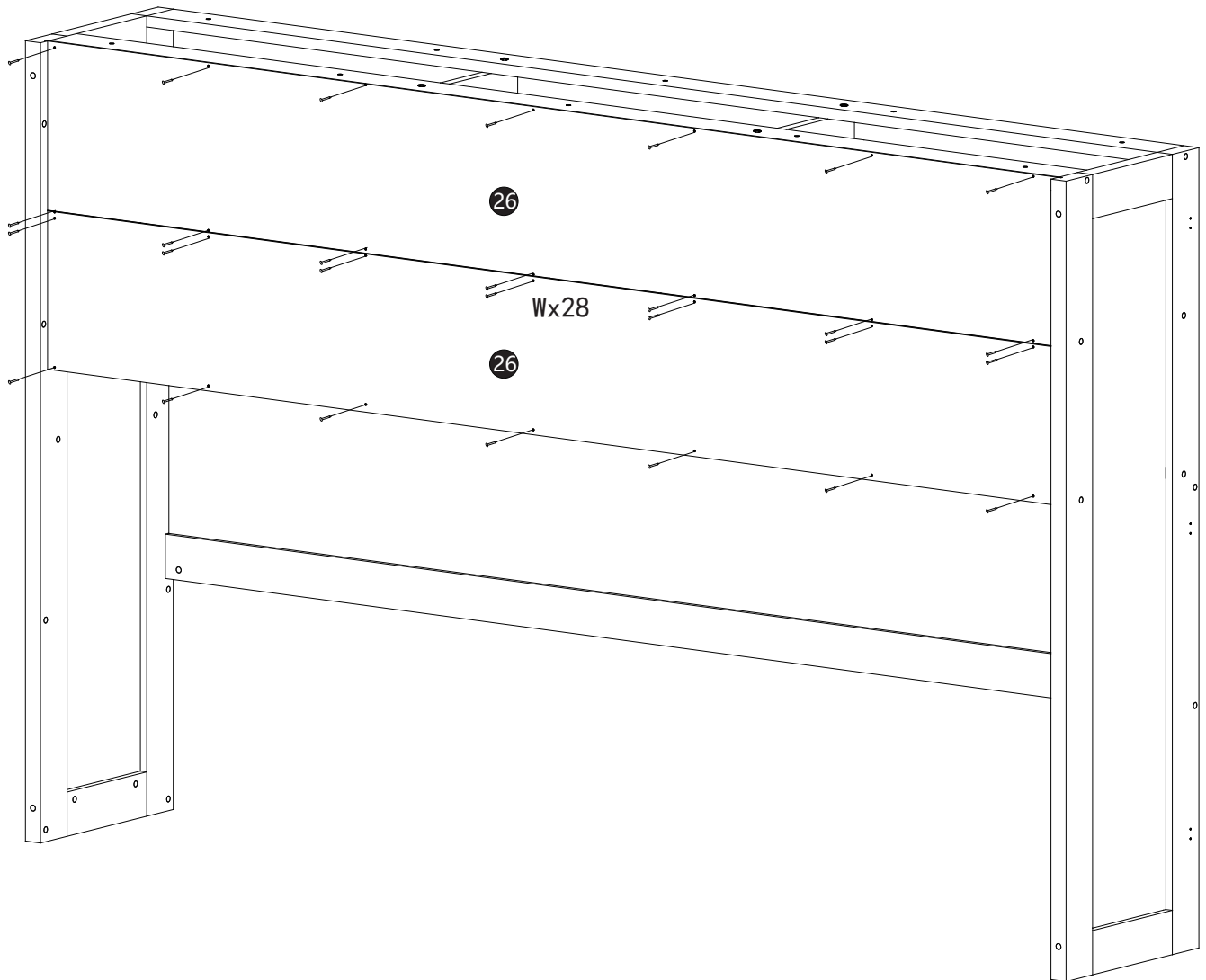

W	
28PCS	



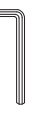

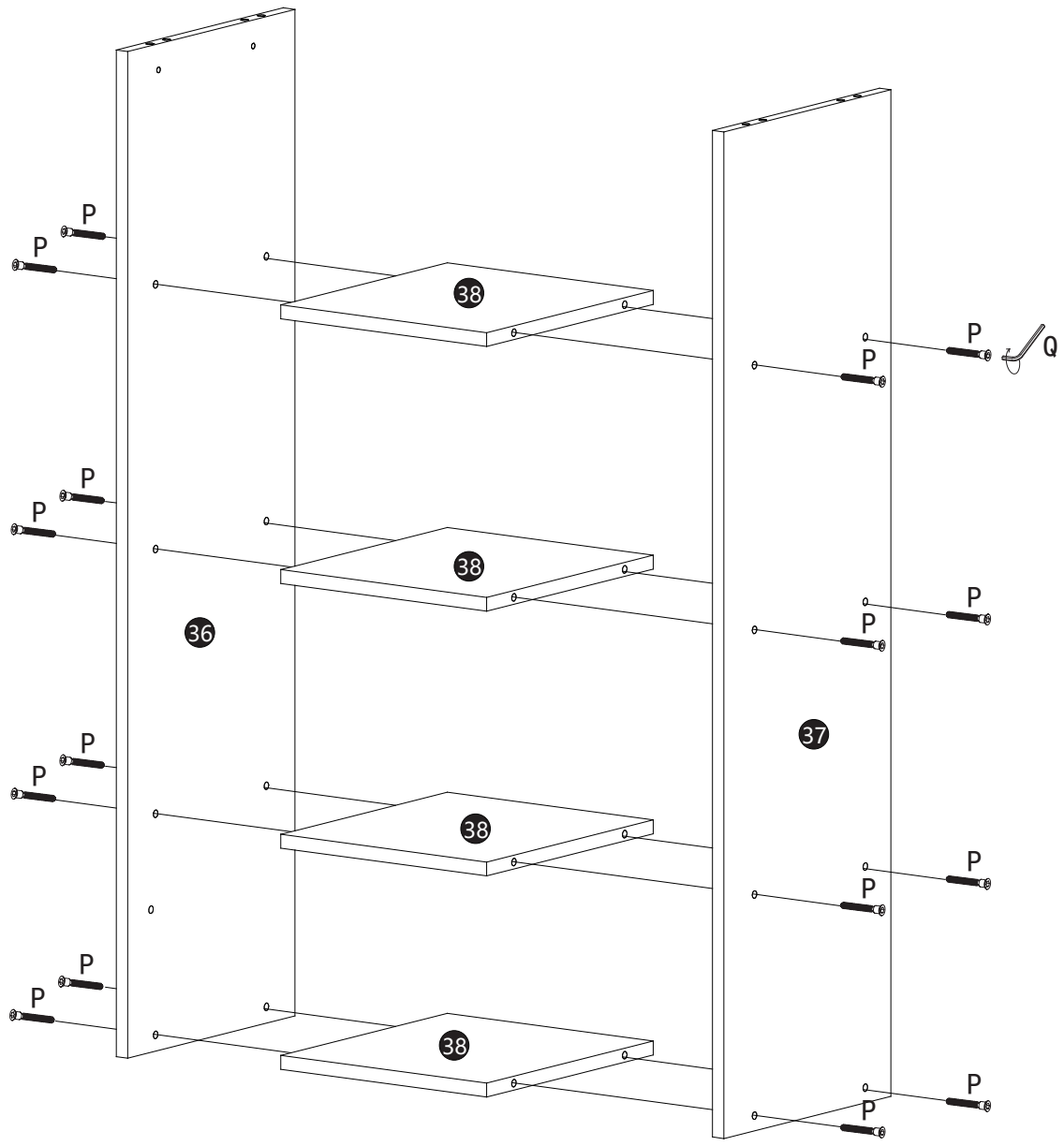
SCHRITT 21:

P		Q	
16PCS		1PC	





Q		F	
M3(1pc)		M4	



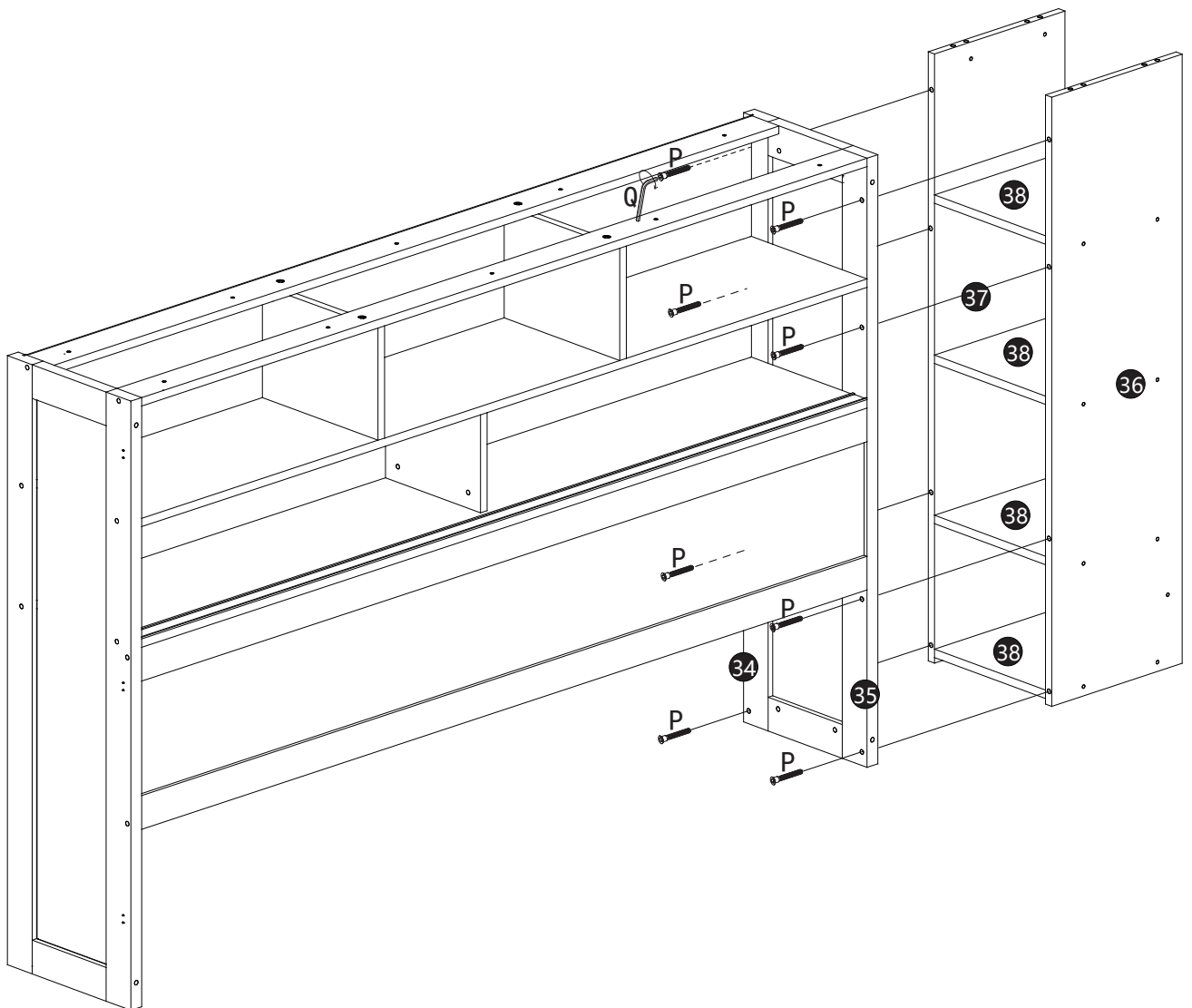

SCHRITT 22:

P		Q	
8PCS		1PC	





Q		F	
	M3(1pc)		M4

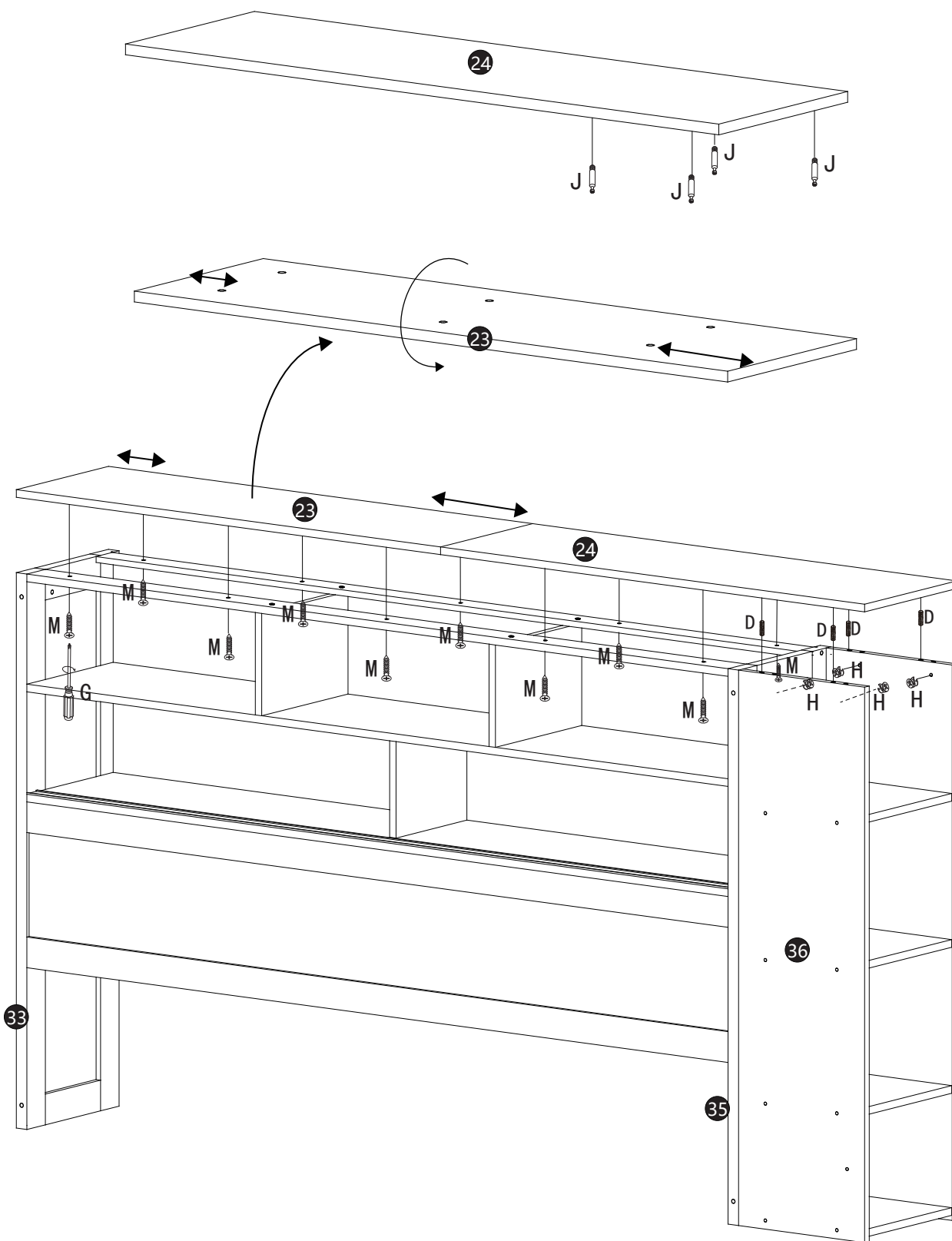

SCHRITT 23:

D		G		M		J		H	
4PCS		1PC		10PCS		4PCS		4PCS	





M		E		L	
	Φ4*25mm (10pcs)		Φ4*30mm		Φ3*14mm



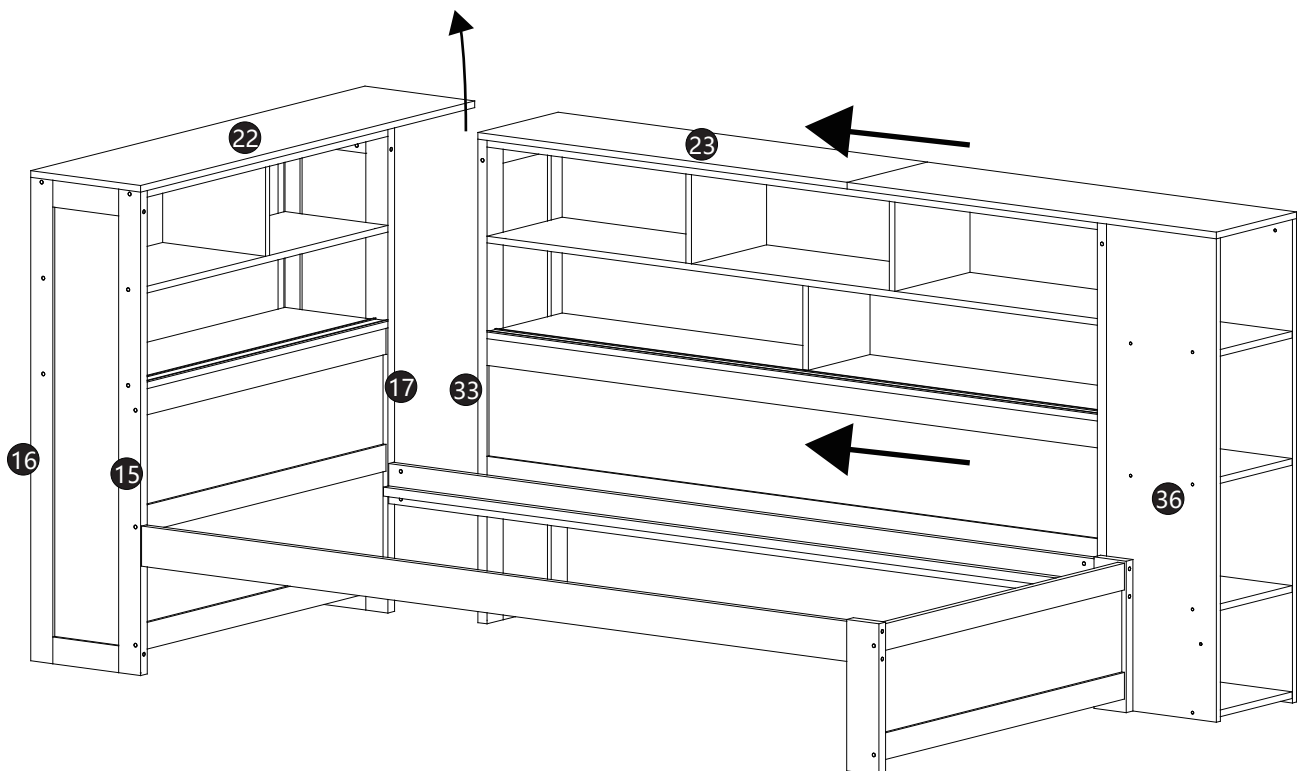
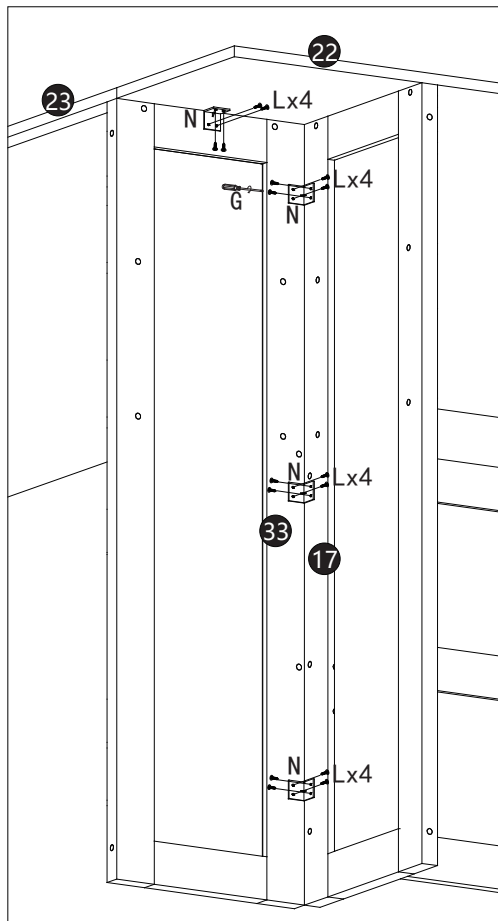





SCHRITT 24:

G		L		N	
1PC		16PCS		4PCS	



L		E		M	
	Φ3*14mm(16pcs)		Φ4*30mm		Φ4*25mm





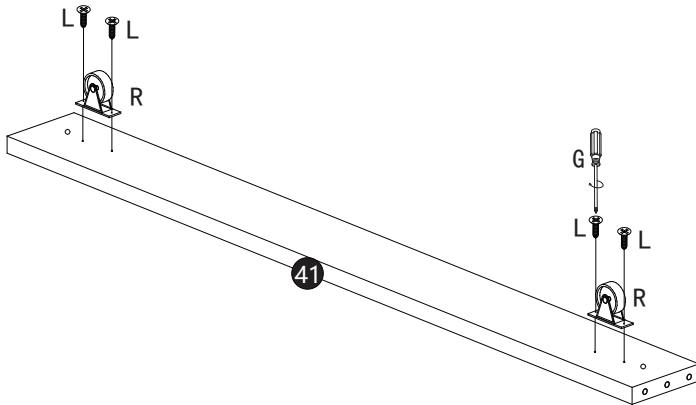

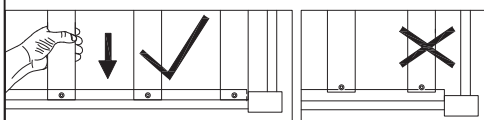
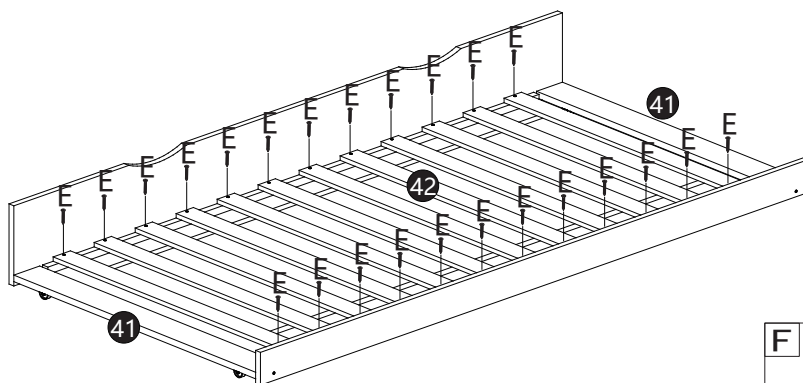
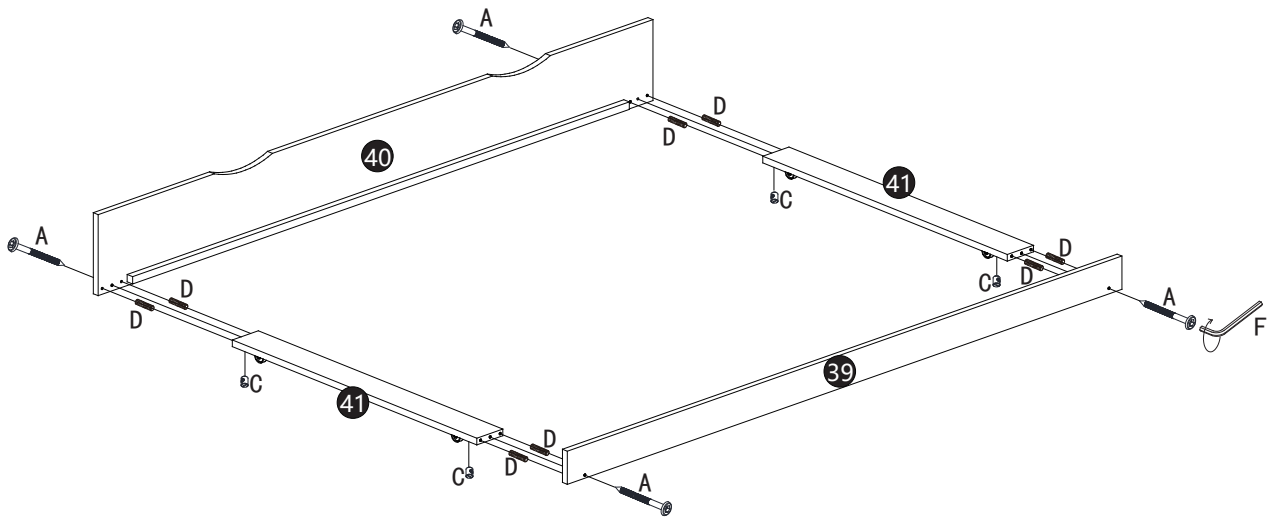

SCHRITT 25:

A 	C 	D 	E 	G 
4PCS	4PCS	8PCS	24PCS	1PC
F 	L 	R 		
1PC	8PCS	4PCS		







x 2





F 	Q 
M4(1pc)	M3
L 	E 
Φ3*14mm(8pcs)	Φ4*30mm
A 	B 
M6*60mm (4pcs)	M6*100mm
M 	K 
Φ4*25mm	M6*130mm

SCHRITT 26:

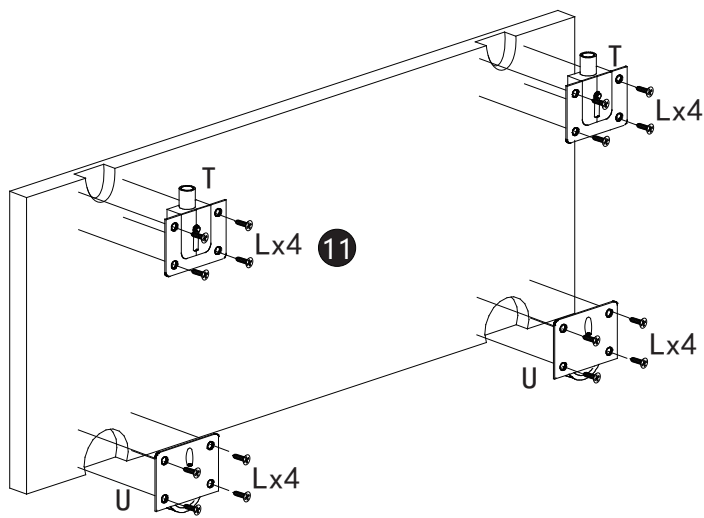
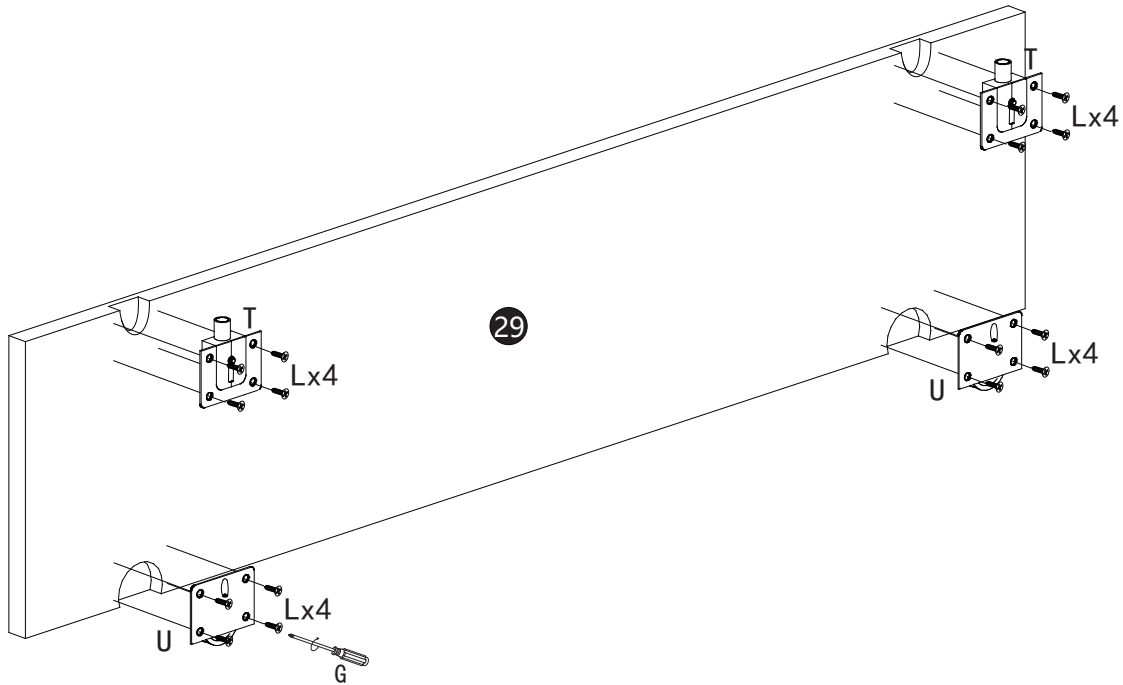



G		L		T		U	
	1PC	64PCS	8PCS	8PCS			





x 2

L		E		M	
	Φ3*14mm(64pcs)	Φ4*30mm	Φ4*25mm		

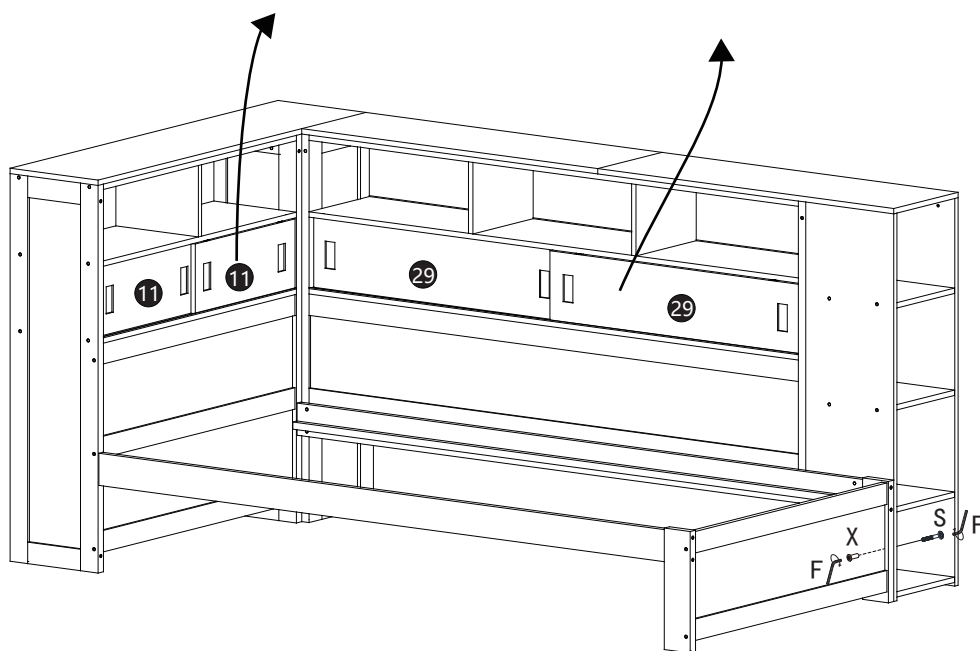
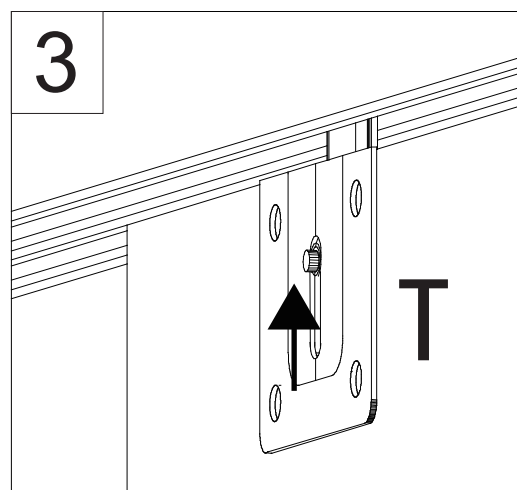
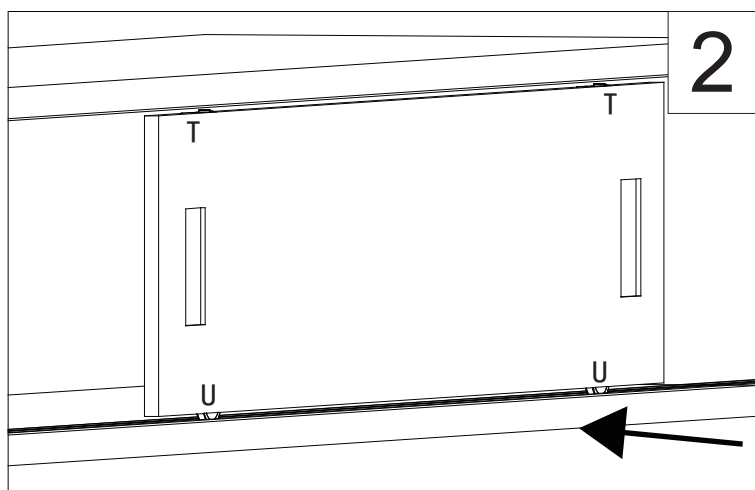
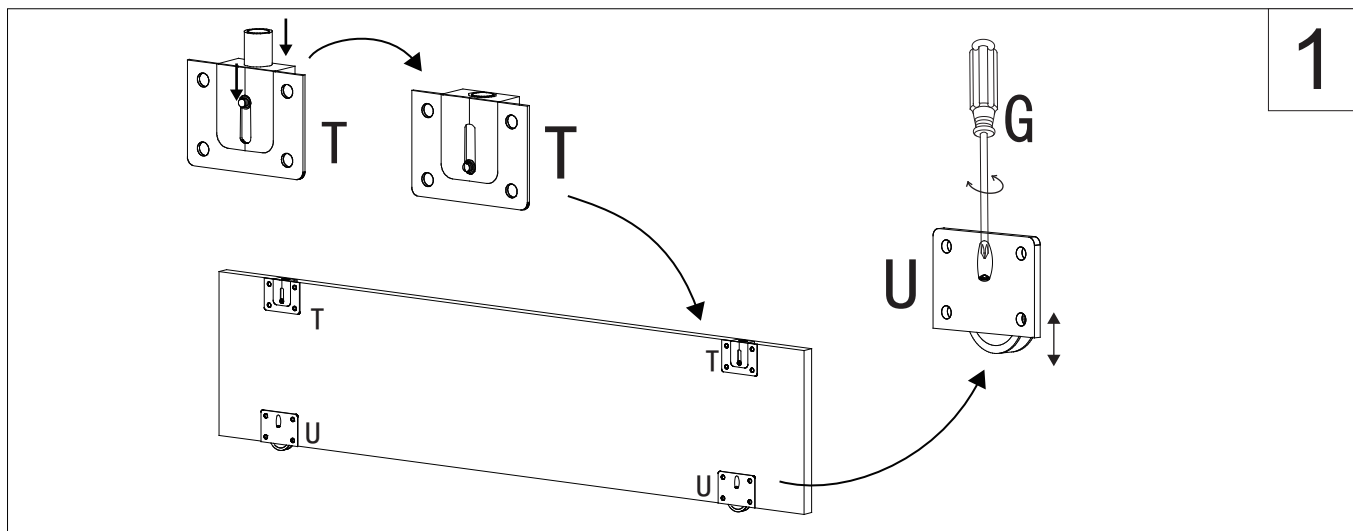

SCHRITT 27:

G 	F 	X 	S 
1PC	2PCS	1PC	1PC



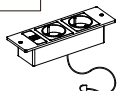

F 
M4 (2pcs)
Q 
M3

SCHRITT 28:

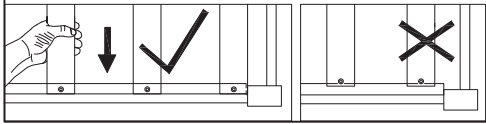
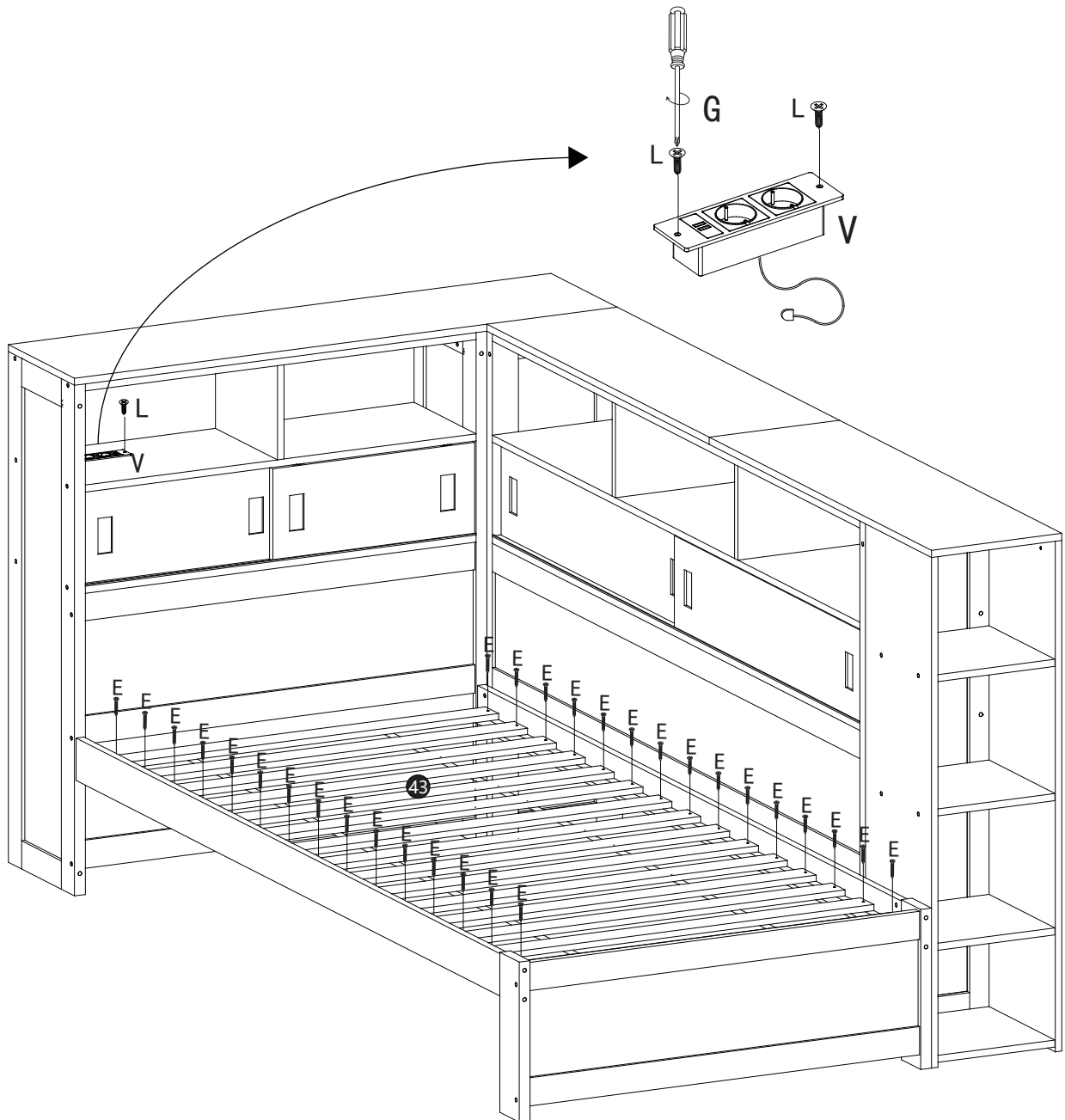
E 	G 	L 	V 
30PCS	1PC	2PCS	1PC



L 	E 	M 
$\Phi 3 \times 14 \text{mm}$ (2pcs)	$\Phi 4 \times 30 \text{mm}$ (30pcs)	$\Phi 4 \times 25 \text{mm}$

SCHRITT 29:

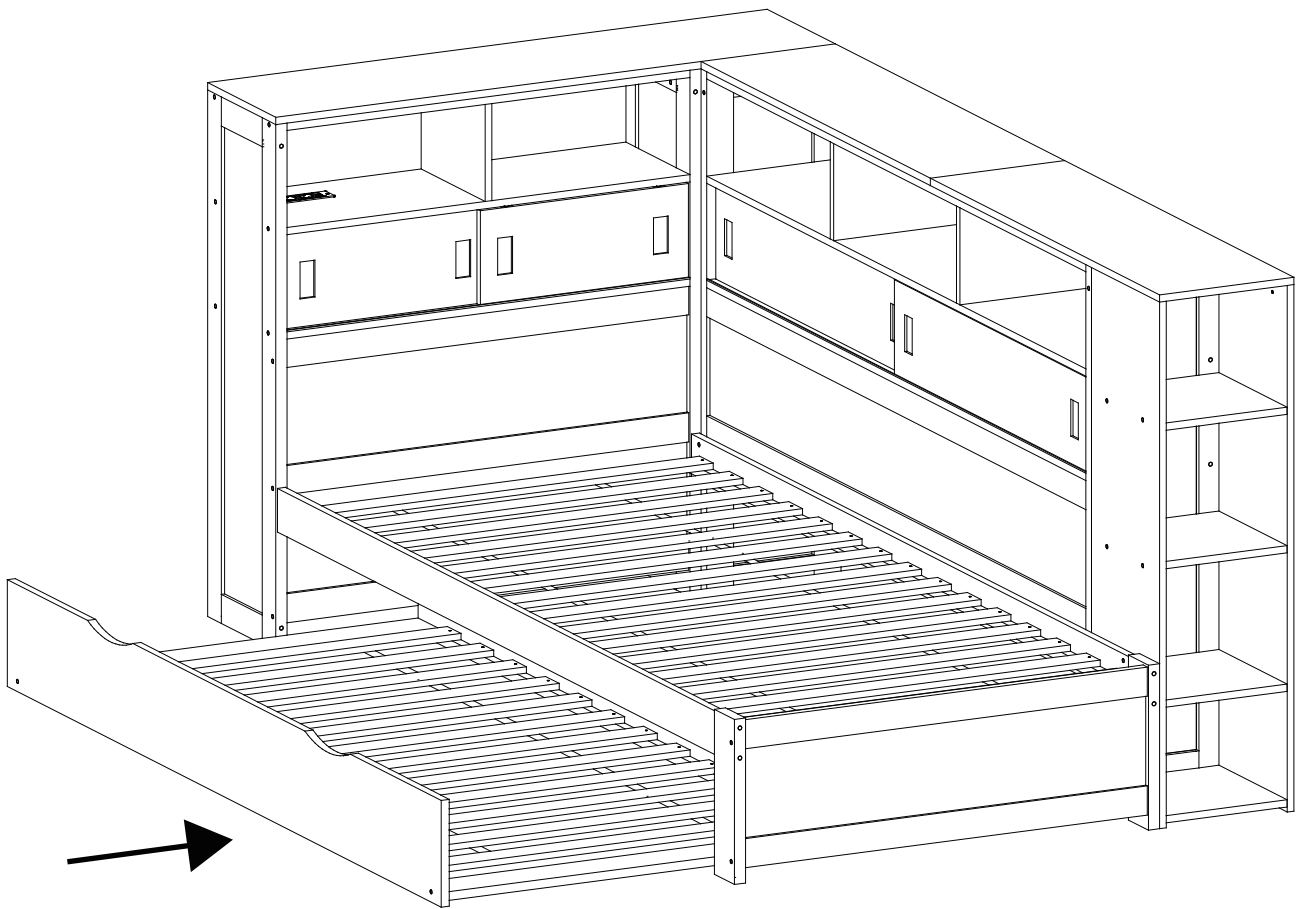

CERTIFICATE OF CONFORMITY

Certificate No.: KEYS23060207001RH-03

Applicant : GUANG TAI ENTERPRISE Co LTD
Address : Rm 402, Bldg 4.No.2 Dapianmei Rd Dapianmei Village, Dalingshang
DONGGUAN GUANGDONG
Manufacturer : GUANG TAI ENTERPRISE Co LTD
Address : Rm 402, Bldg 4.No.2 Dapianmei Rd Dapianmei Village, Dalingshang
DONGGUAN GUANGDONG
Product : USB power socket
Model No. : JN02-00-22 JN02-00-23K JN02-00-21 JN02-00-23 JN02-00-23M
JN00-00-04 JN00-00-03K JN02-00-22 JN00-00-04K JN02-00-23KM
JN00-00-02 JN00-00-02K JN02-00-22M JN02-00-21M JN00-00-02KM
JN00-00-03KM JN00-00-04M JN00-00-04KM

RoHS 2.0 Directive (EU) 2015/863 and (EU)2017/2102 amending Annex II to Directive 2011/65/EU.

The standard(s) used for showing compliance with the essential requirements:

Applicable Standard(s) IEC 62321-3-1: 2013
IEC 62321-4:2013 +AMD1:2017
IEC 62321-5:2013
IEC 62321-6:2015
IEC 62321-7-1:2015
IEC 62321-7-2:2017
IEC 62321-8:2017

The EUT described above has been consolidated by us and found in compliance with the council RoHS 2.0 Directive (EU) 2015/863 and (EU)2017/2102 amending Annex II to Directive 2011/65/EU.

The certificate applies to the tested sample above mentioned only and shall not imply an assessment of the whole production. It is only valid in connection with the test report number.

KEYS23060207001RH-03

RoHS



Tony Qian/Approved Signatory
Date: Jun. 06, 2023

Guangdong KEYS Testing Technology Co., Ltd.

Address: Room 206, Building 1, Huagu Technology Center, No. 6 Hehe Street, Hengkeng, Liaobu Town, Dongguan City, Guangdong Province

6/F., Building B, Chuangyigu Industrial Park, No.5, Hehe Street, Songxi Road, Hengkeng, Liaobu, Dongguan, Guangdong, China/523413

Tel:+ 86-0769-89798319 <http://www.keys-lab.com> E-mail: info@keys-lab.com



SLG-CPC Testlaboratory Co., Ltd.

VERIFICATION OF CONFORMITY

No.: 24050296C-C

This verification is issued for

GUANG TAI ENTERPRISE CO., LTD

Rm 402, Bldg 4.No.2 Dapianmei Rd., Dapianmei Village, Dalingshan DONGGUAN, Guangdong Sheng CN

The product with designation of type

Furniture Power Distribution Unit

Trade Mark: /

Model/s: JN02-00-21; JN00-00-04KM; JN00-00-02K; JN00-00-02KM; JN00-00-03KM; JN02-00-23K; JN00-00-04; JN02-00-23; JN02-00-22M; JN02-00-23M; JN00-00-04K; JN00-00-03K; JN02-00-23KM; JN02-00-22; JN02-00-24K; JN02-00-24; JN02-00-24M; JN02-00-24KM

This is to declare that the technical file of the products complies the essential requirements of below European Directives:

EMC Directive 2014/30/EU

Reference standards:

EN IEC 55014-1:2021

EN IEC 55014-2:2021

EN IEC 61000-3-2:2019+A1:2021

EN 61000-3-3:2013/A2:2021/AC:2022-01

This verification is based on the following file

90340-24-71-24-PP002

and is valid only if the product is manufactured in accordance with the corresponding tested sample.

This verification is the result of tests carried out on one sample and does not represent the serial production of this product.

The CE mark as shown can be used, under the responsibility of the manufacturer, after completion of an EC Declaration of Conformity and compliance with all relevant EC Directives.

This verification of conformity loses its validity in the following cases:

- if the reference standards and/or EC Directives are modified;
- if any modifications are made to the model/s without our approval.



May. 13, 2024

(Date)

Jason gao

Jason Gao
Lab Manager



SLG-CPC Testlaboratory Dongguan Co., Ltd.

VERIFICATION OF CONFORMITY

No.: 24050295C-C

This verification is issued for

GUANG TAI ENTERPRISE CO LTD

Rm 402, Bldg 4, No.2 Dapianmei Rd., Dapianmei Village, Dalingshan, DONGGUAN, Guangdong, China

The product with designation of type
Furniture Power Distribution Unit

Trade Mark: N/A

**Model/s: JN00-00-02K; JN00-00-02KM; JN00-00-03K; JN00-00-03KM; JN00-00-04; JN00-00-04K;
JN00-00-04KM; JN02-00-21; JN02-00-22; JN02-00-22M; JN02-00-23; JN02-00-23K; JN02-
00-23M; JN02-00-23KM; JN02-00-24K; JN02-00-24; JN02-00-24M; JN02-00-24KM**

This is to declare that the technical file of the products complies the essential requirements of below
European Directives:

Low Voltage Directive 2014/35/EU;

Reference standards:

**IEC 60884-2-7:2011+ AMD1:2013
IEC 60884-1:2002 + AMD1:2006
IEC 62368-1:2018 (EN IEC 62368-1:2020 + A11:2020)**

This verification is based on the following file

90340-24-70-24-PP001

And is valid only if the product is manufactured in accordance with the corresponding tested sample.

This verification is the result of tests carried out on one sample and does not represent the serial
production of this product.

The CE mark as show can be used, under the responsibility of the manufacturer, after completion of an
EC Declaration of Conformity and compliance with all relevant EC Directives.

This verification of conformity loses its validity in the following cases:

- if the reference standards and/or EC Directives are modified;
- if any modifications are made to the model/s without our approval.



2024-05-11

(Date)

Owen Zhan
Owen Zhan
Technical Director