

**D** Montageanleitung

**GB** Assembly instructions

**CZ** Montážní návod

**SK** Návod na montáž

**FR** Notice de montage

**IT** istruzioni di montaggio

**HU** Szerelési útmutató

**RO** Instrucțiunile de montaj

**NL** Handleiding voor de montage

**PL** Instrukcja montażu

**TR** Montaj talimatı

**RU** Инструкция по монтажу

# SOMBA 1

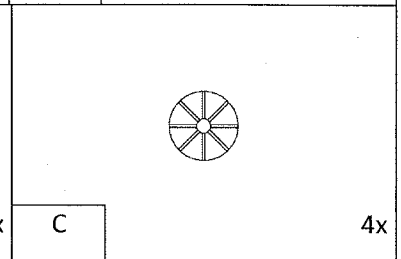
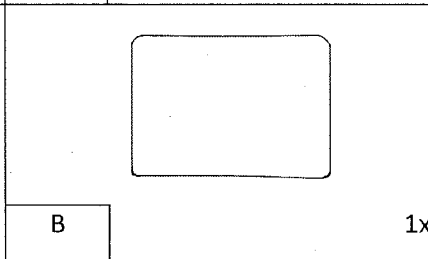
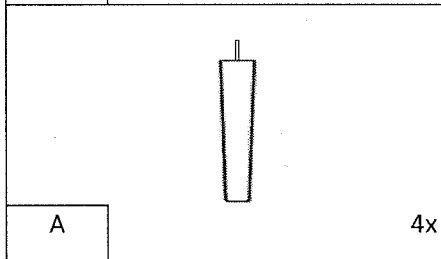
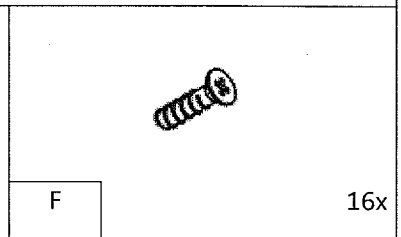
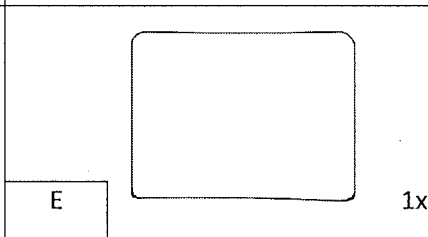
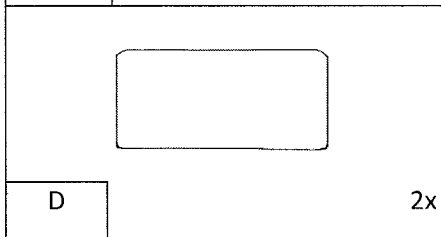
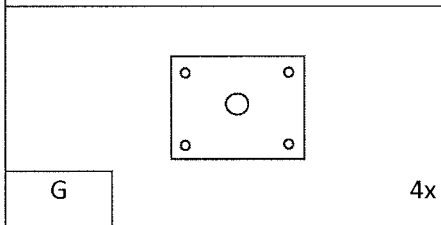
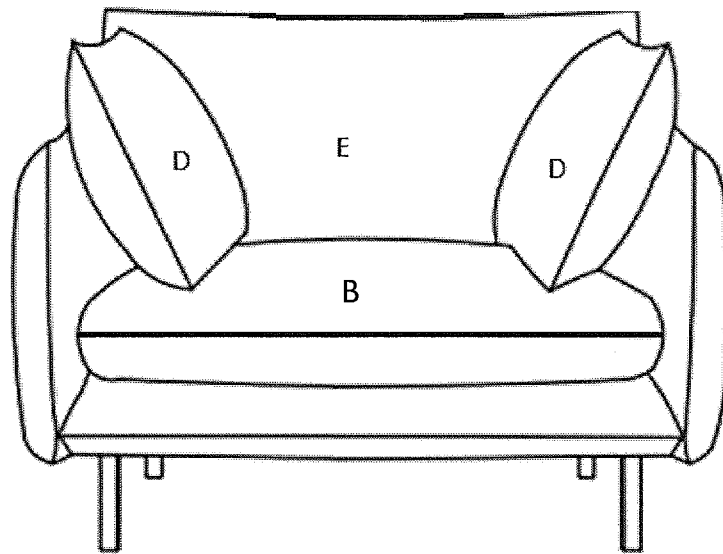
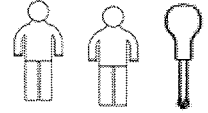

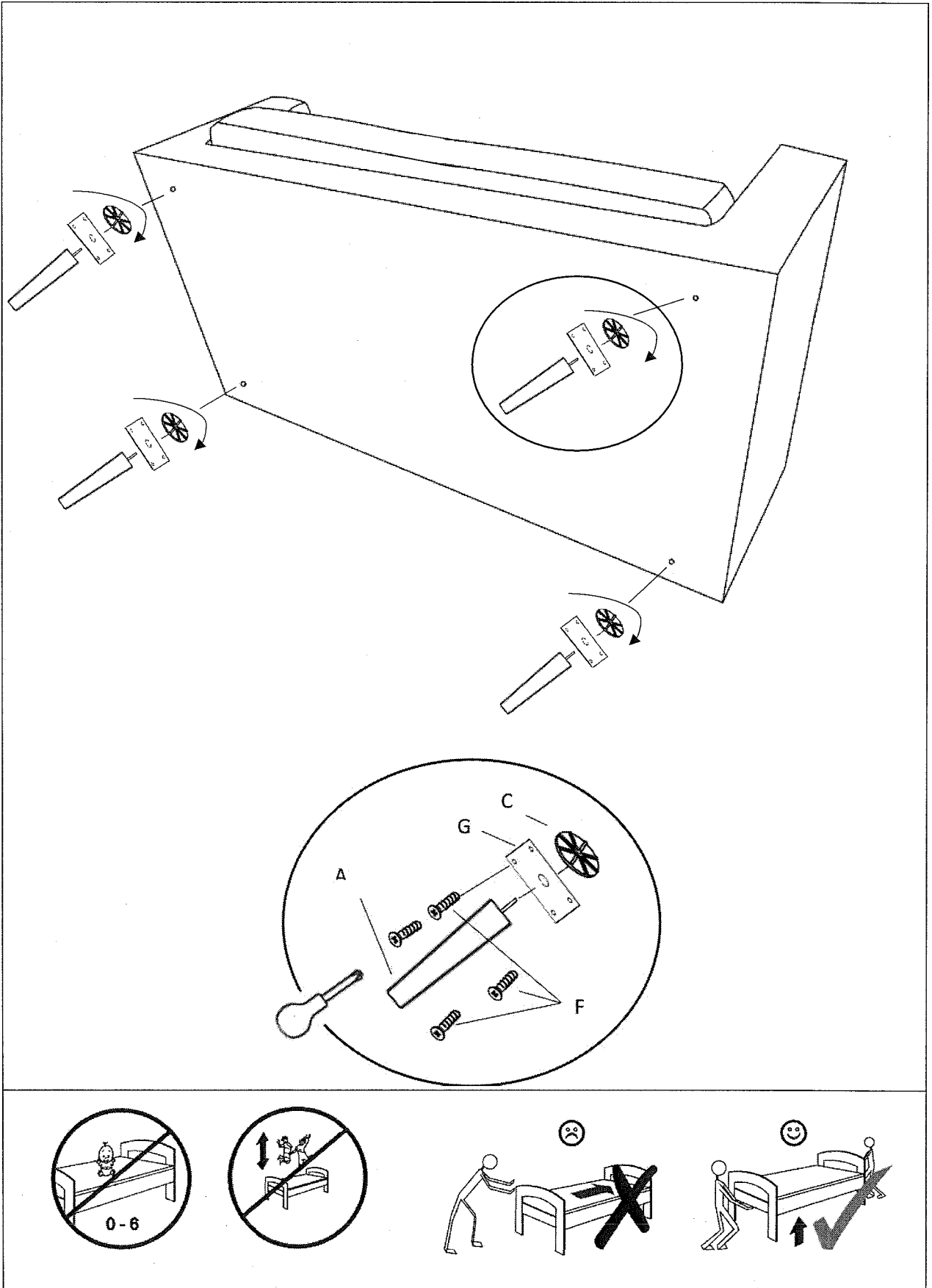

**Service • Assistenza • Dienstverlening • Serwis  
 Servis • Szerviz • Сервисная служба**

Name • Naam • Nazwa • Isim • Название

**SOMBA**

Nr. • No. • Номер

Typ • Type • Тип • Тип

**1**

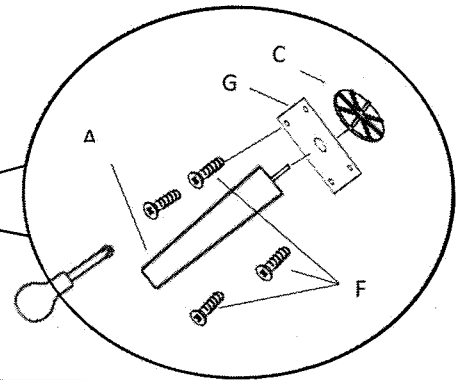
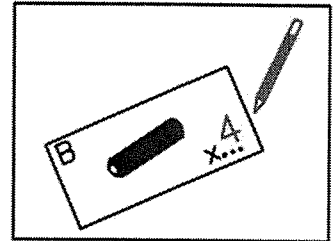
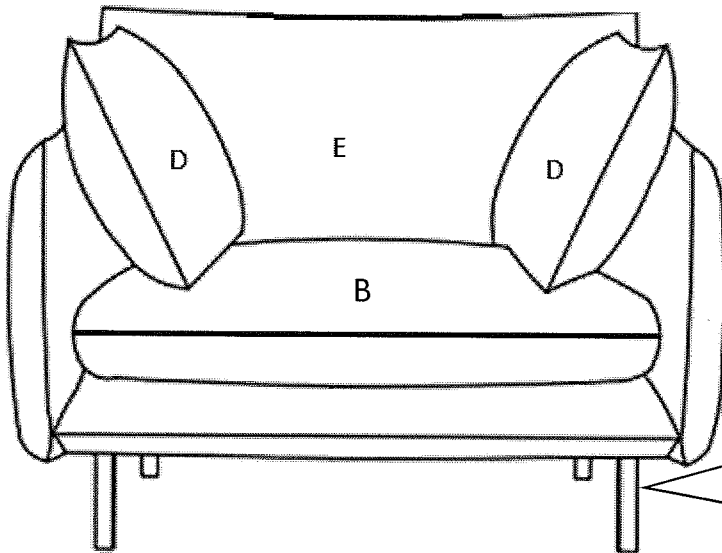
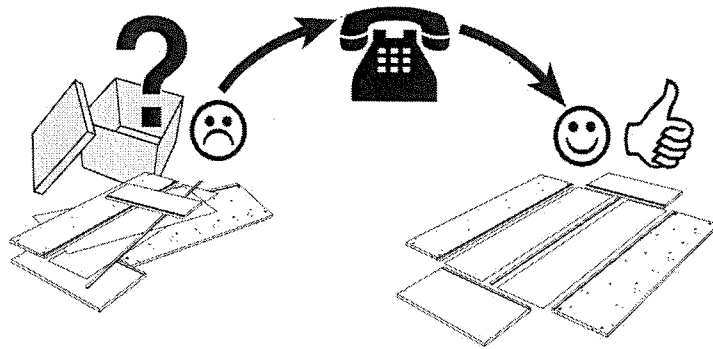
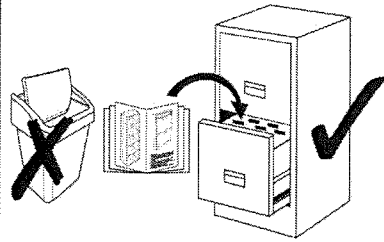

E	.....	F	.....
A	.....	B	.....
		C	.....
			D