

30.11.2011

Stand

00

Revision

VHÖ

Verfasser

1 / 1

Seite(n)

Rücken- / Kopfteilverstellung

Bezeichnung

FOB_BE_0023

lfd. Nr.

1

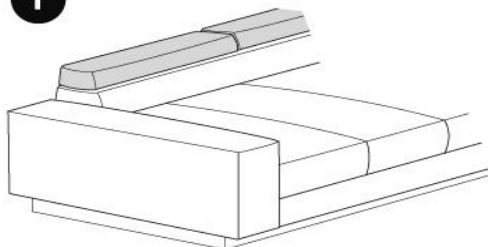

2

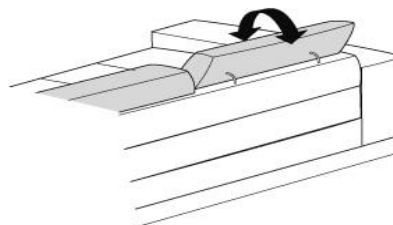
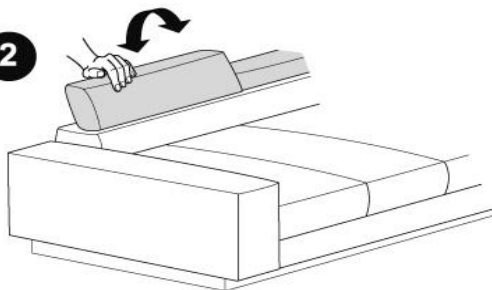

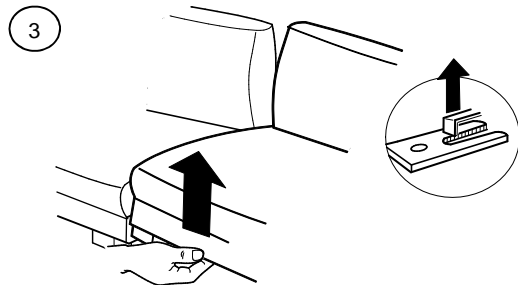
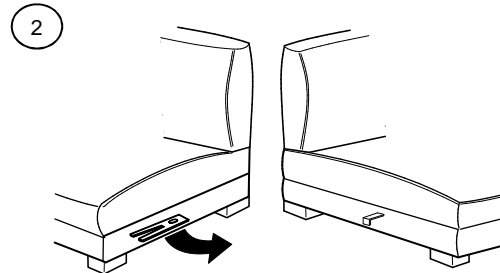
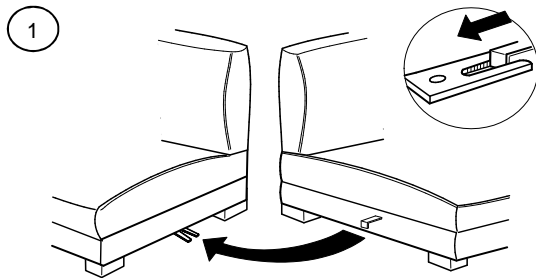

30.11.2011

Stand

00

Revision

VHÖ

Verfasser

1 / 1

Seite(n)

Bedienungsanleitung Elementverbinder

Bezeichnung

FOB_MO_0004

lfd. Nr.

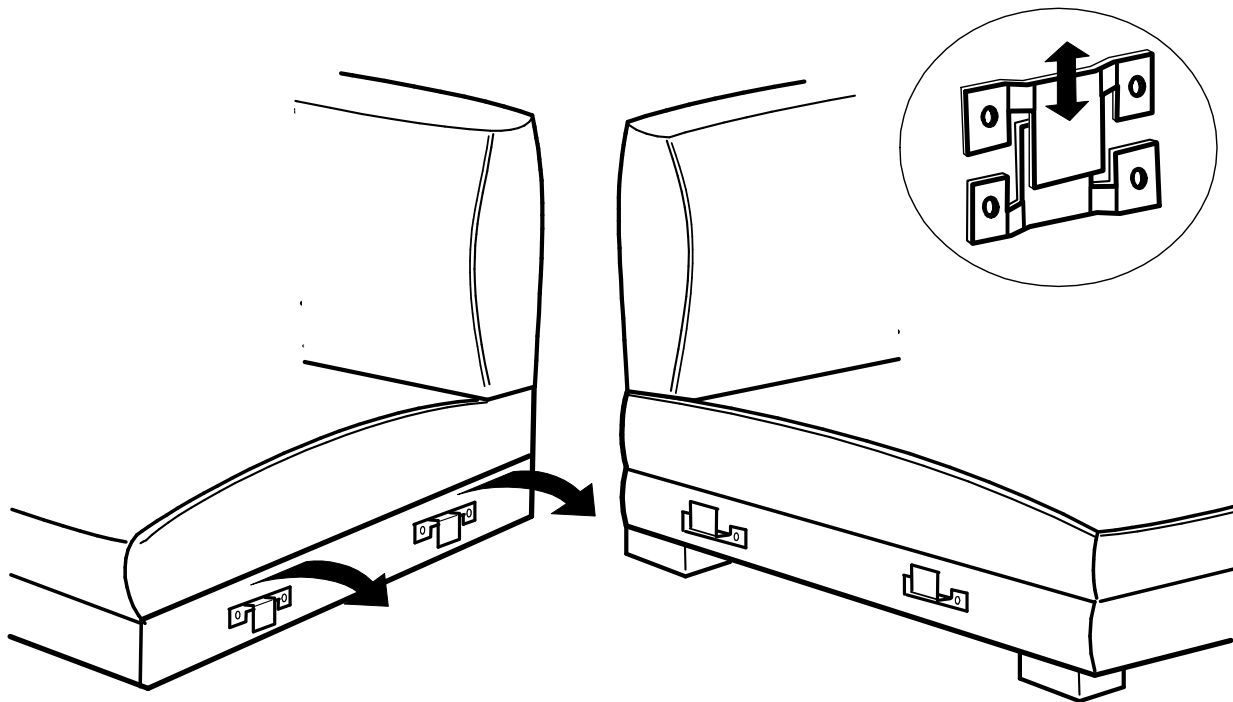

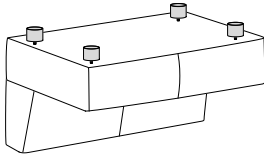

2-Sitzer ohne Armlehnen
 Fest oder Sitzauszug

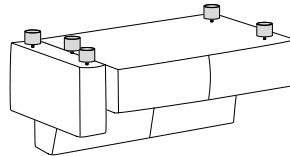

2-Sitzer Armlehne links/rechts
 Fest

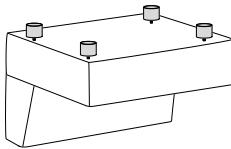

1,5-Sitzer ohne Armlehnen
 Fest oder Sitzauszug

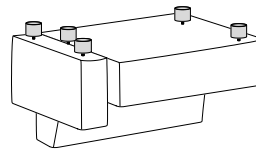

1,5-Sitzer Armlehne links/rechts
 Fest

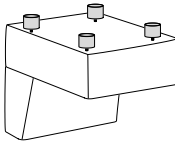

1-Sitzer ohne Armlehnen
 Fest oder Sitzauszug

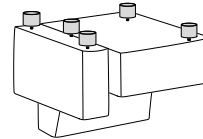

1-Sitzer Armlehne links/rechts
 Fest

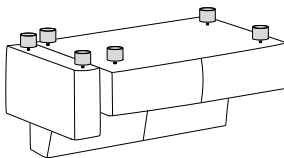

2-Sitzer Armlehne links/rechts
 Sitzauszug

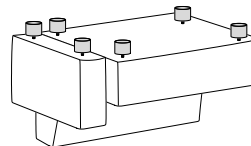

1,5-Sitzer Armlehne links/rechts
 Sitzauszug

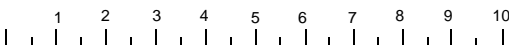

(A) Höhe 5 cm	(B) Höhe	(C) Höhe	(D) Höhe	(E) Höhe	(F) Höhe	Modellnummer 540, 2374
						Stand 07.12.2016
Gleiter						Revision 03
Werkseitig						Verfasser TKA

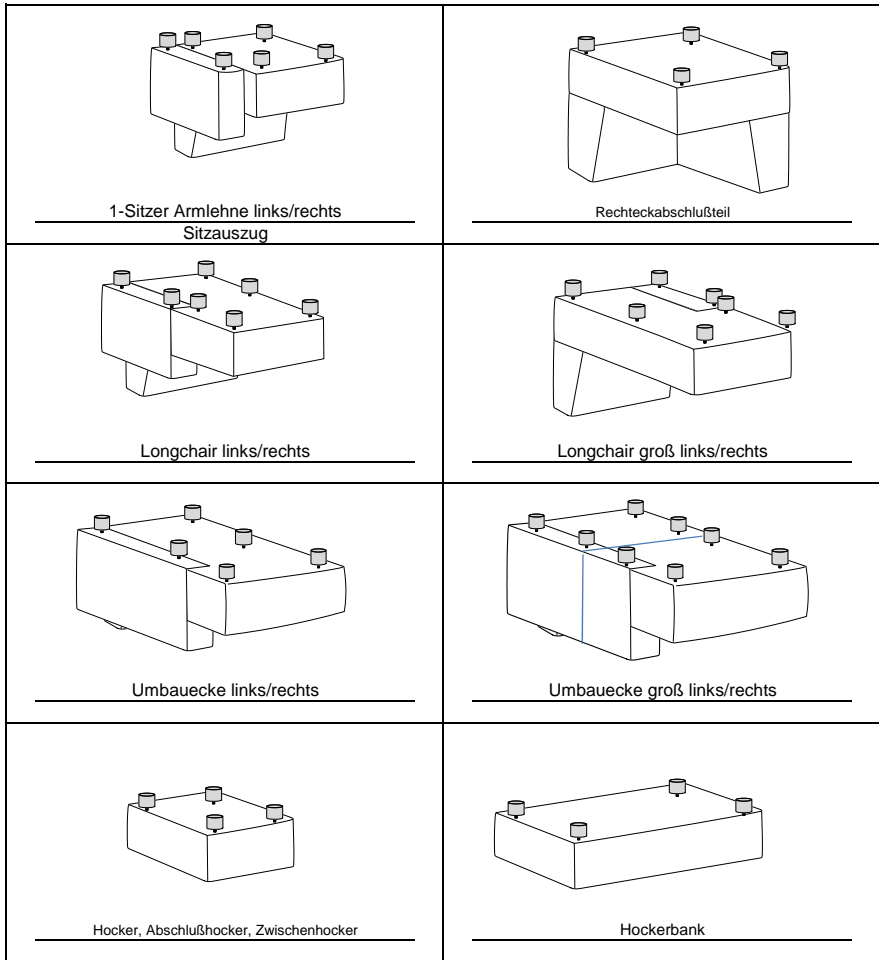

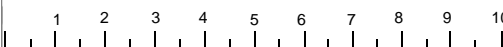

<p>(A) Höhe 5 cm</p>	<p>(B) Höhe</p>	<p>(C) Höhe</p>	<p>(D) Höhe</p>	<p>(E) Höhe</p>	<p>(B)</p>	<p>Modellnummer 540_2374</p>
						<p>Stand 07.12.2016</p>
<p>Gleiter</p>						<p>Revision 03</p>
<p>Werkseitig</p>						<p>Verfasser TKA</p>
						<p>Seite 2 - 3</p>

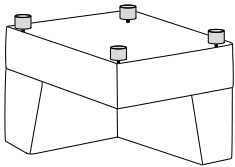

 <p style="text-align: center;">Spitzeckteil klein</p>	<hr/>
 <p style="text-align: center;">Montage</p>	<hr/>
<hr/>	<hr/>
<hr/>	<hr/>

(A) Höhe 5 cm	(B) Höhe	(C) Höhe	(D) Höhe	(E) Höhe	(F)	Modellnummer 540_2374
						Stand 07.12.2016
Gleiter						Revision 03
Werkseitig						Verfasser TKA

