

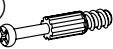











- B1**   $\phi$  8x28 x14
- T1**  x12
- M1**  x12
- C2**   $\phi$  20 x12
- C2**   $\phi$  20 x4
- W2**  x2
- W1**  x4
- F11**  x4
- S19**  3,5x30 x8

- X5**  x4
- S9**  4x16 x8
- D2**  x4
- U79**  x2
- P5**  4x30 x4
- J11**  x2
- P13**  3,5x13 x4
- T17**   $\phi$ 8x50 5x60 x2

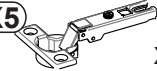
Nr	Ausmaß			St
1	494	396	16	2
2	501	284	16	1
3	501	284	16	1
4	768	250	16	1
5	768	60	16	1
6	768	120	16	1
7	802	305	22	1
8	802	305	22	1

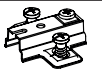
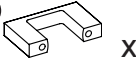
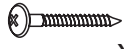
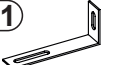

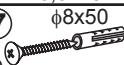
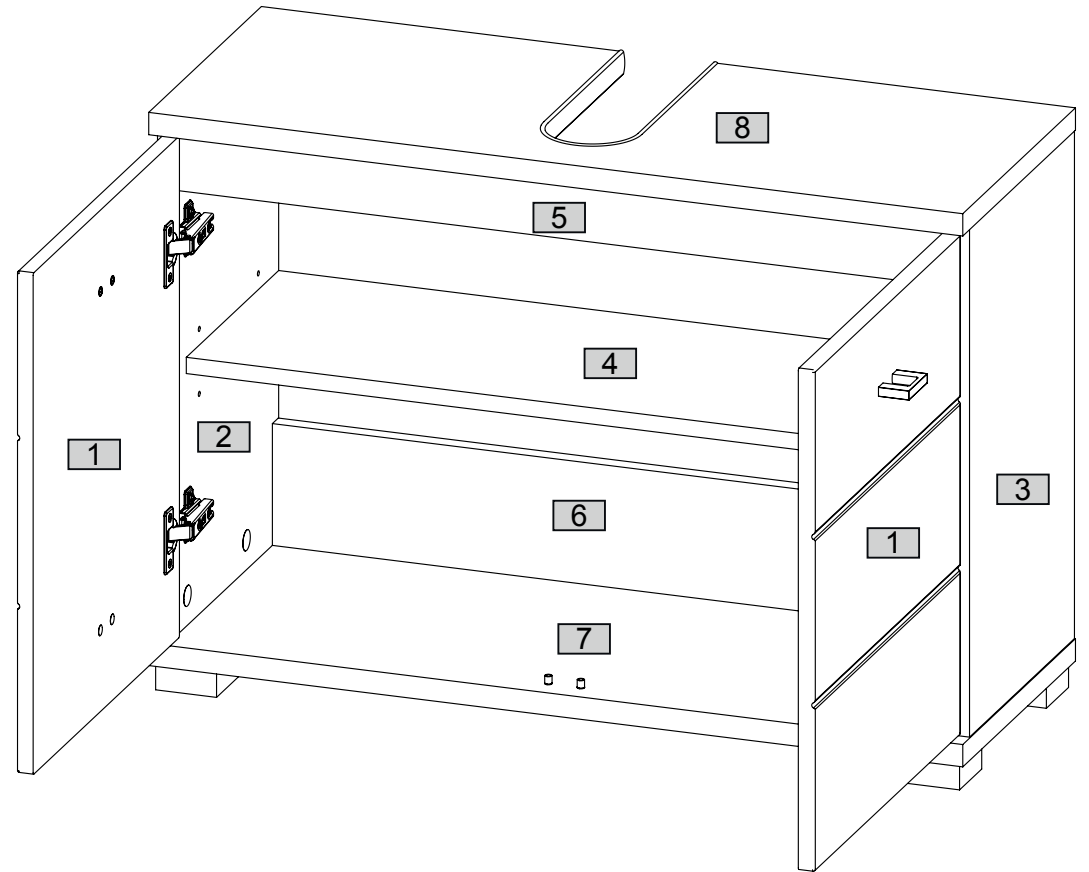
1

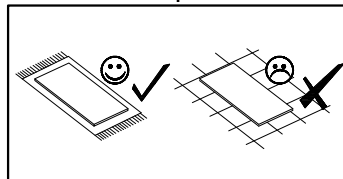
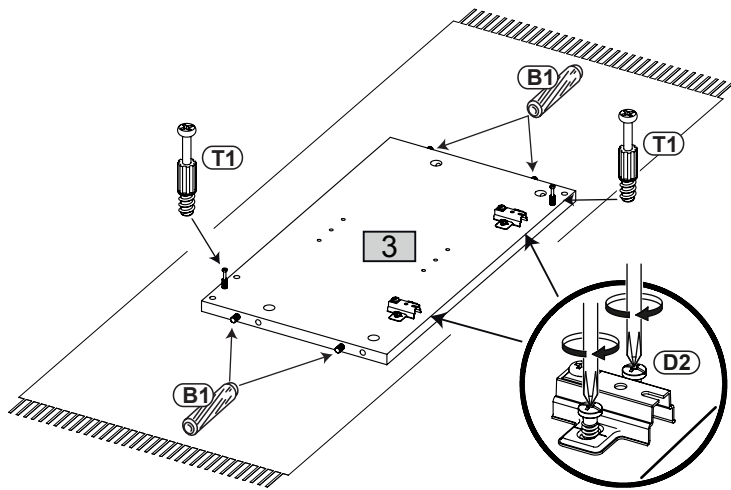
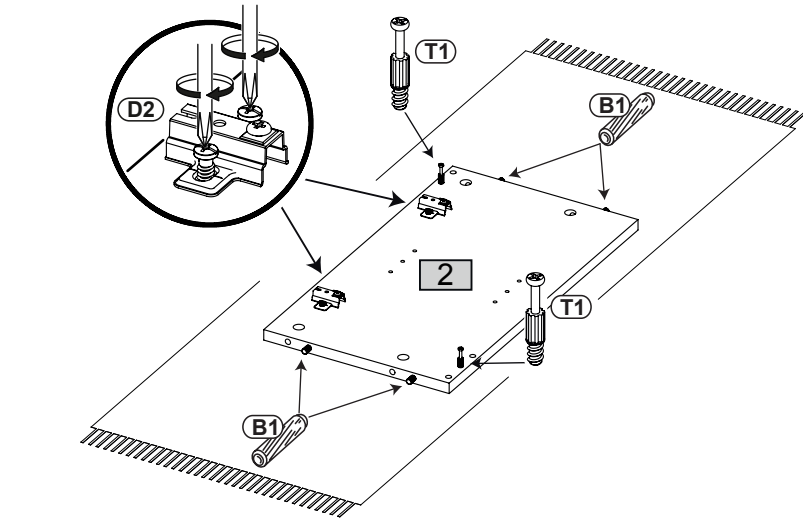
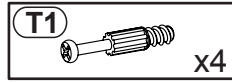
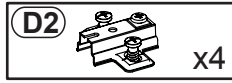
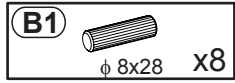

2

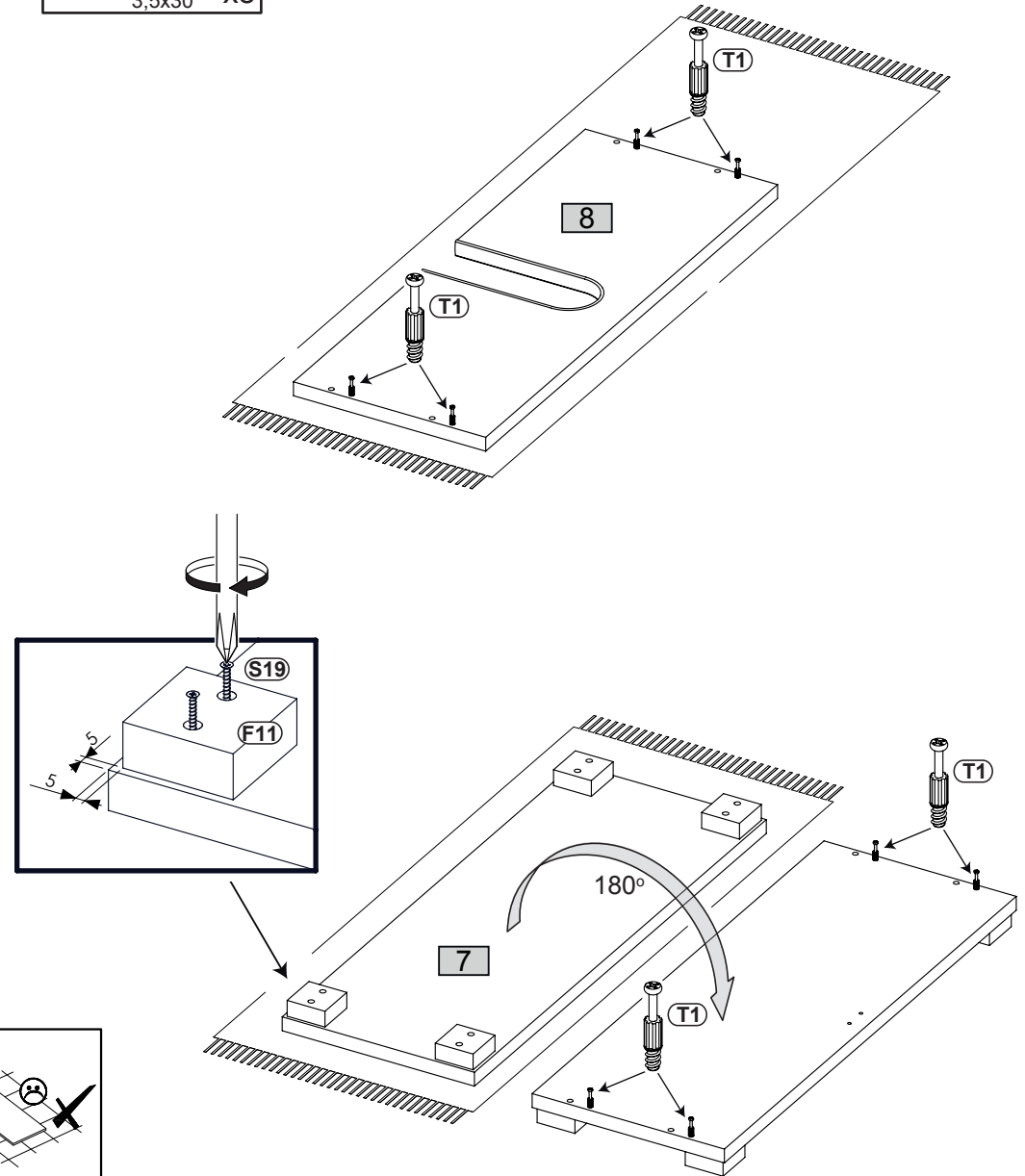
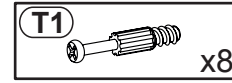
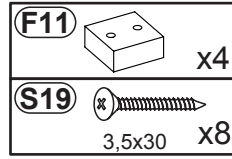

3

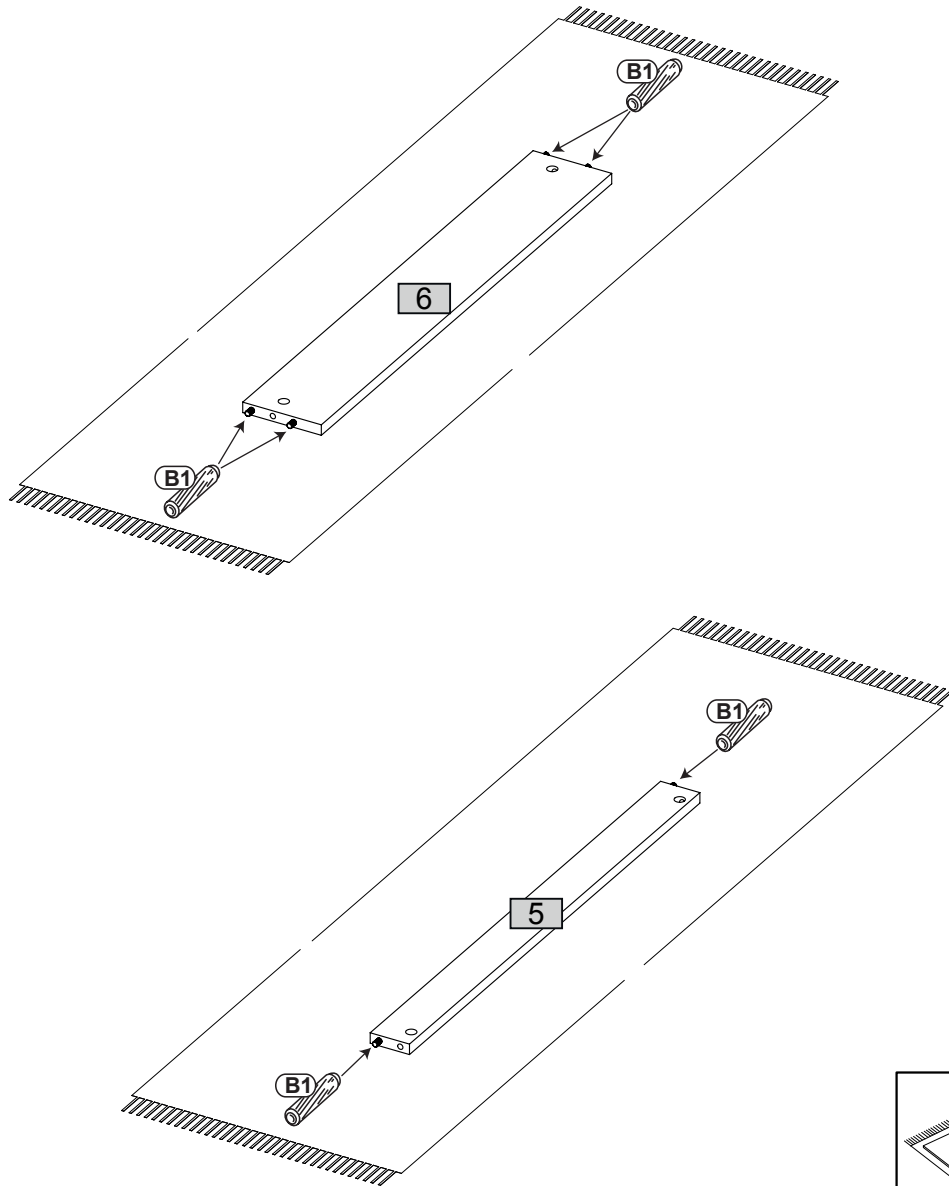
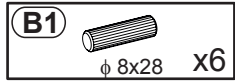

4

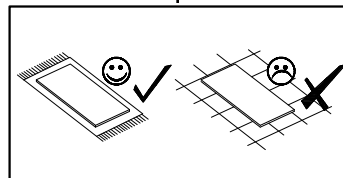
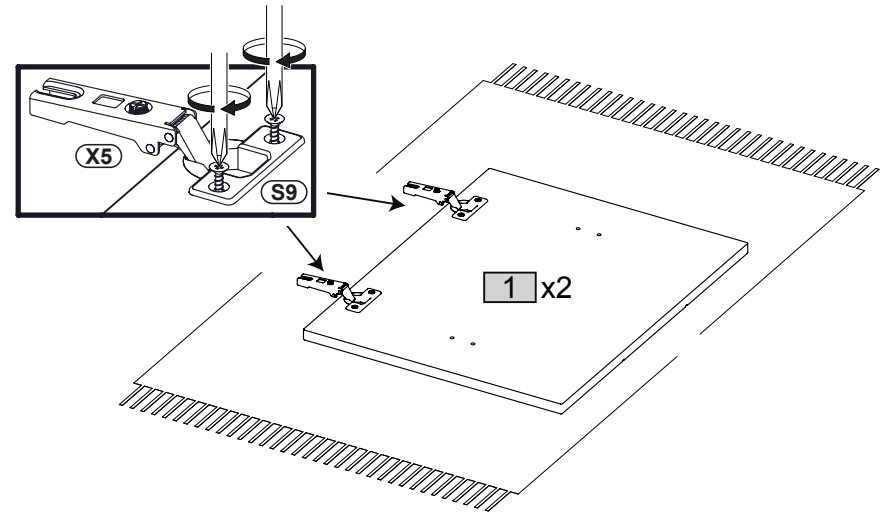
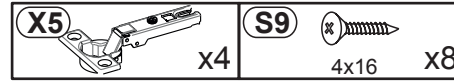

5 **M1**  x4

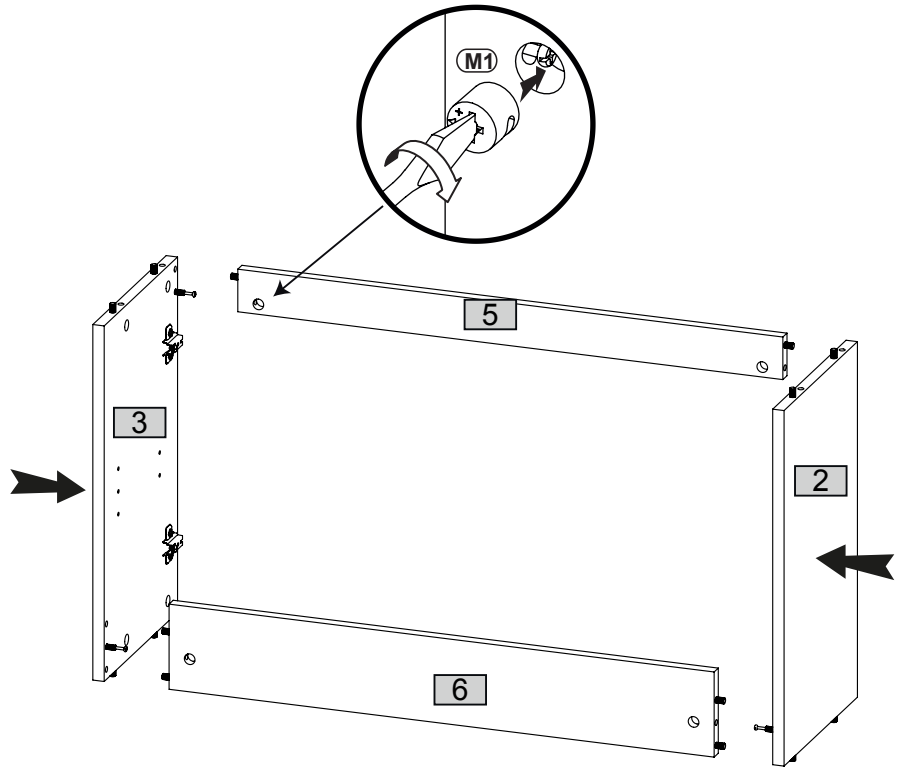

6 **M1**  x8

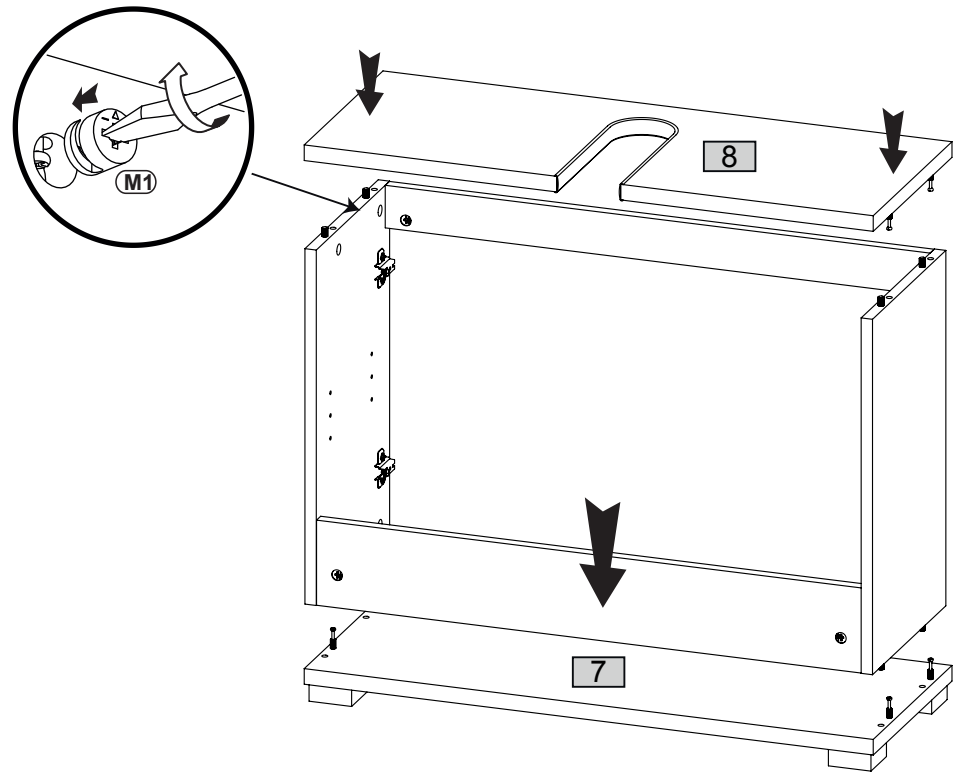

7

