

(D) Montageanleitung

(I) Istruzioni di montaggio

(CZ) Montážní návod

LKZ 41194

(GB) Assembly instructions

(NL) Handleiding voor de montage

(SK) Návod na montáž

(F) Notice de montage

(PL) Instrukcja montażu

(HU) Szerelési útmutató

(RO) Instrucțiuni de montaj

(TR) Montaj talimatı

(RU) Инструкция по монтажу



SILKEBORG SI-75

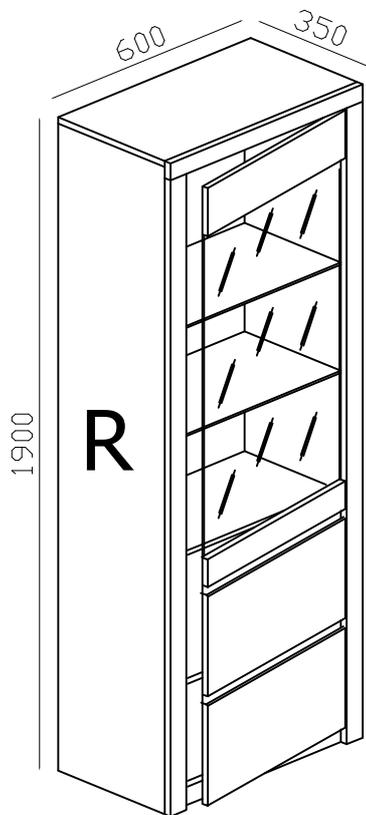

R ? L

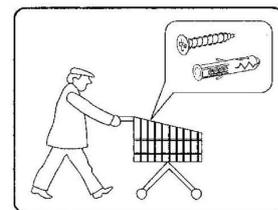
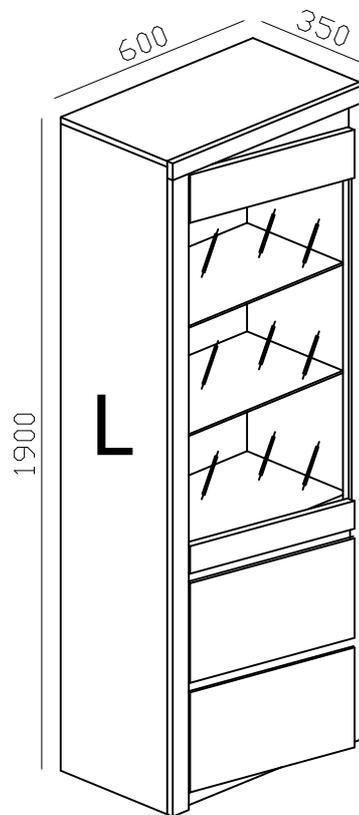
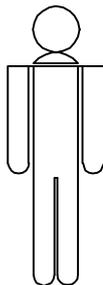

! Uwaga • Achtung • Attention • Caution • Figyele • Attenzione • Opgelet
Atentje • Upozornenie • Dikkat • Upozornění • Внимание **!**

(D) Bitte nur mit einem Staubtuch oder leicht feuchtem Lappen reinigen.
Keine scheuernden Putzmittel verwenden

(GB) Please only with a duster or a damp cloth.
Do no use any abrasive cleaners

(F) Le nettoyage se fait uniquement à l'aide d'un torchon ou d'une serviette
légèrement mouillée

(RO) Curățarea trebuie efectuată numai o cârpă sau cu un prosop ușor umezit
Nu utilizați agenți de curățare abrazivi

(I) Pulire esclusivamente con un panno o un asciugamano umido

(NL) Reinig alleen met een stofdoek of een lichtjes vochtige doek
Gebruik geen schurende poetsmiddelen

(PL) Czyszczenie należy wykonać wyłącznie za pomocą ściereczki lub lekko nawilżonego
ręcznika. Nie stosować środków czyszczących do szorowania

(TR) Lütfen sadece bir toz bezilye veya hafif nemli yumuşak bir bezle siliniz.
Aşındırıcı temizlik malzemeleri kullanmayınız

(CZ) Čistění je nutné vykonávat výhradne pomoci utěrky nebo lehce navlhčeného ručníku.
Nepoužívejte čističi prostředky obsahující abrazivní částice

(SK) Čistení je nutné vykonávať výhradne pomoci utierky alebo ľahko zvlhnutým ručníkom
Nepoužívajte čistiaci prostriedky obsahujúci abrazivní částice

(HU) A tisztítás kizárólag törölrőruha vagy enyhén nedvesített törölköző segítségével végezhető.
Súroló hatású tisztítószereket nem szabad használni

(RU) Очищайте от пыли тряпкой или слегка влажной ветошью. Не допускается применение
чистящих средств, не пред-назначенных для ухода за мебелью.

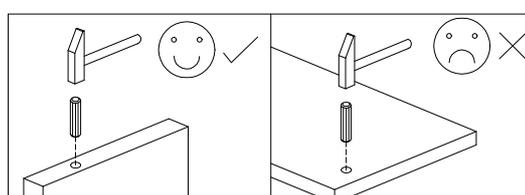
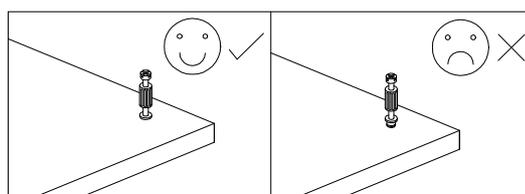
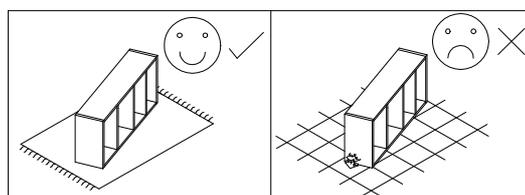
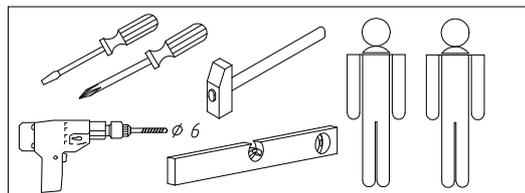

(D) Servicekarte

(RO) Carte de service

(PL) Karta serwisowa

(SK) Služobný preukaz

(GB) Service card

(I) Carta di servizio

(TR) Servis karti

(HU) Szerviz kártya

(F) Carte de service

(NL) Dienst kaart

(CZ) Servisni karta

(RU) Сервисная карта

SILKEBORG SI-75

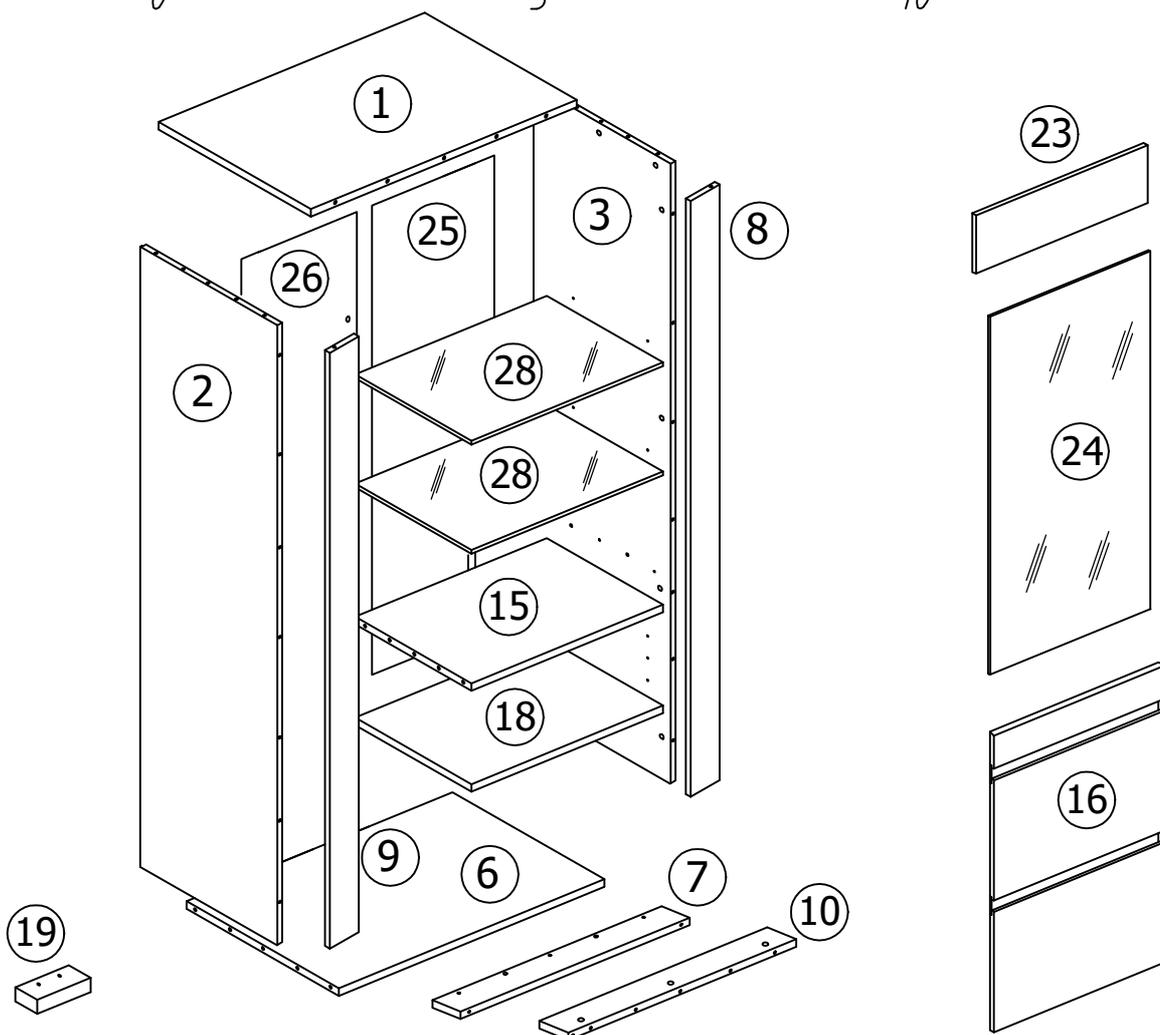
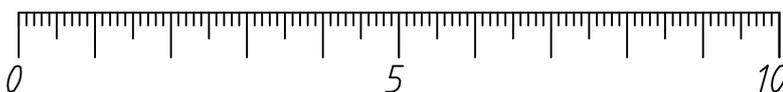
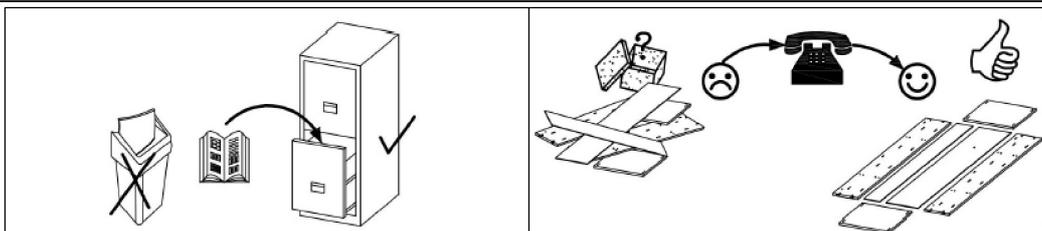

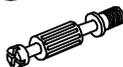
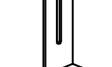
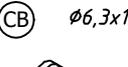
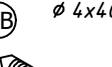
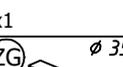
| | | | | | | | | | |
|--|--|--|--|--|---|--|--|--|--|
| (A)  x34 | (B)  x34 | (C)  x14 | (D)  x22 | (E)  x4 | (J)  x1 | (R)  x50 | (AB)  x6 | (AV)  x1 | |
| (BO)  x2 | (BW)  x1 | (BZ)  x8 | (CB)  x6 | (CP)  x1 | (CR)  x6 | (DB)  x1 | (FG)  x4 | (FS)  x3 | |
| (GB)  x6 | (ZG)  x3 | (ZS)  x3 | | | | | | | |

B

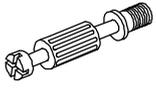

x12

D

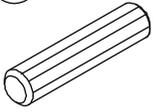

x10

1

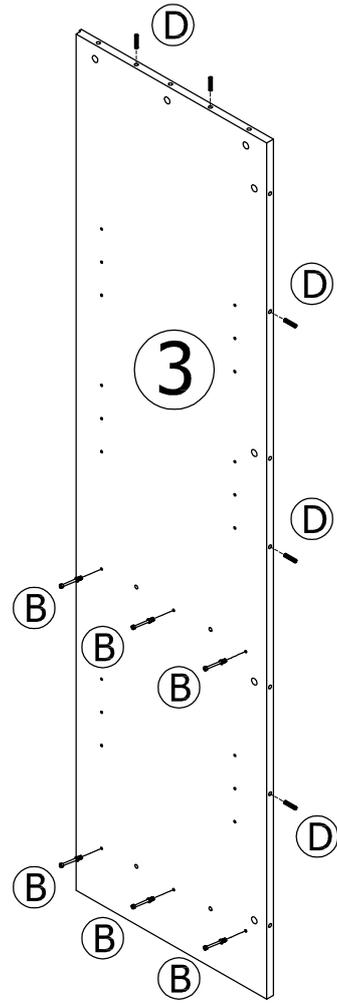
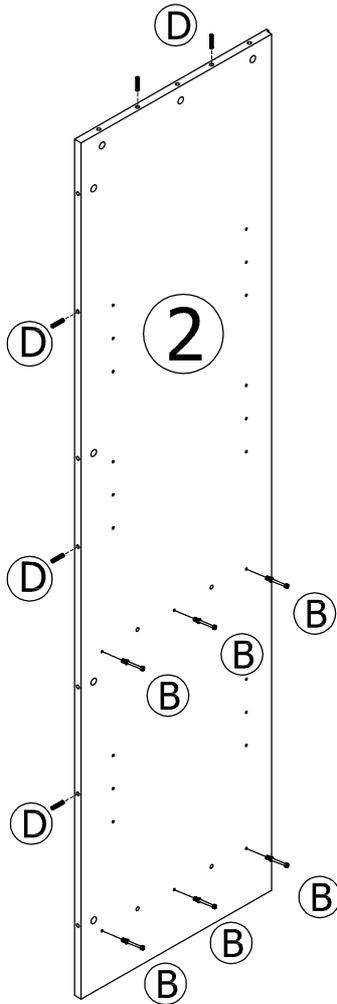
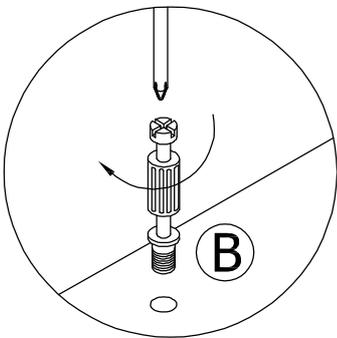
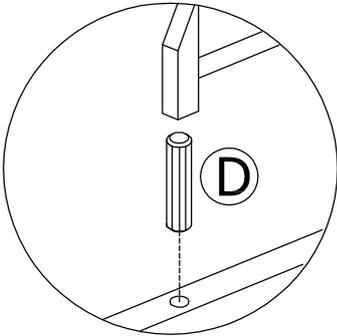

3

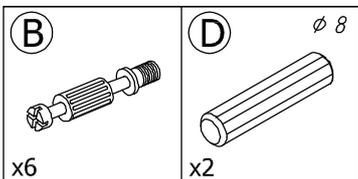

2

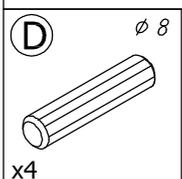
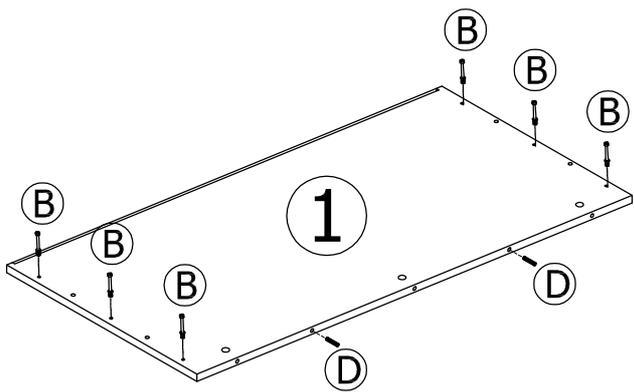
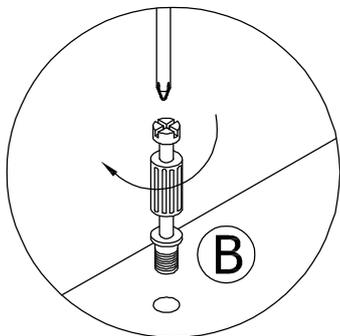

3

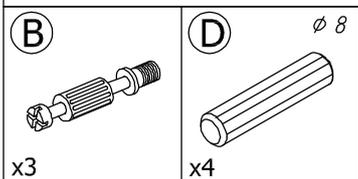
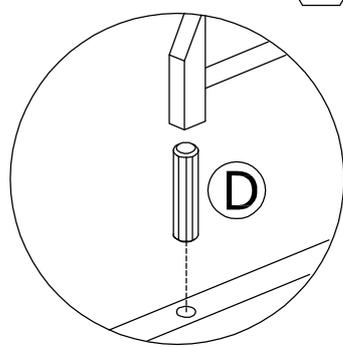
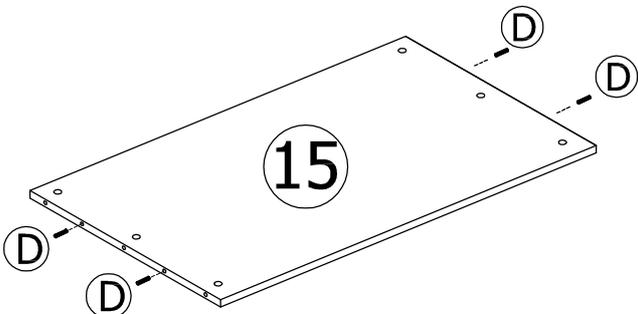

4

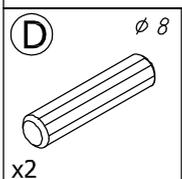
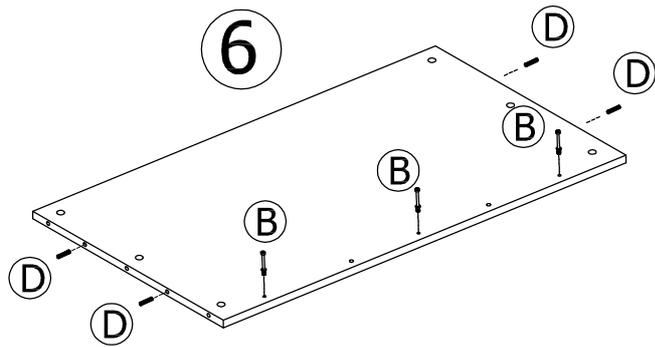

5

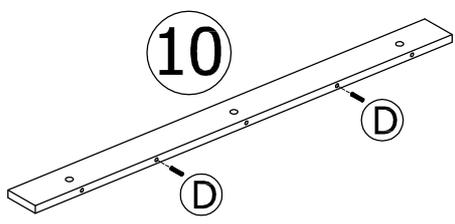

4

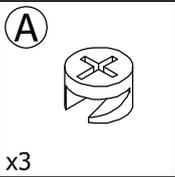

6

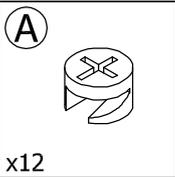
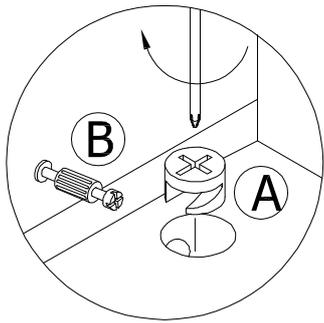
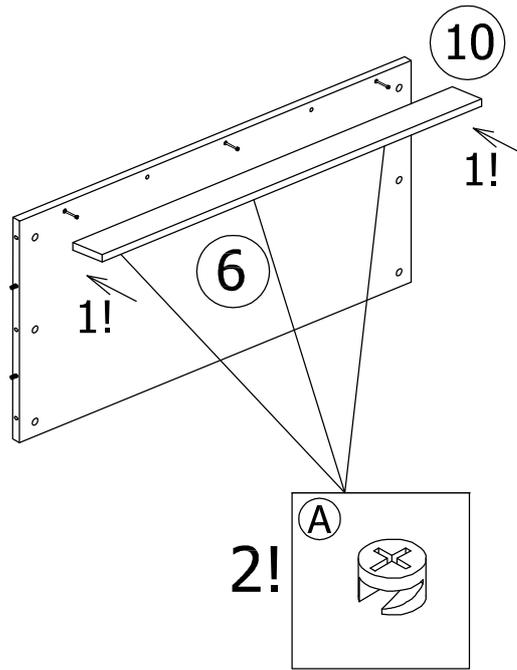

7

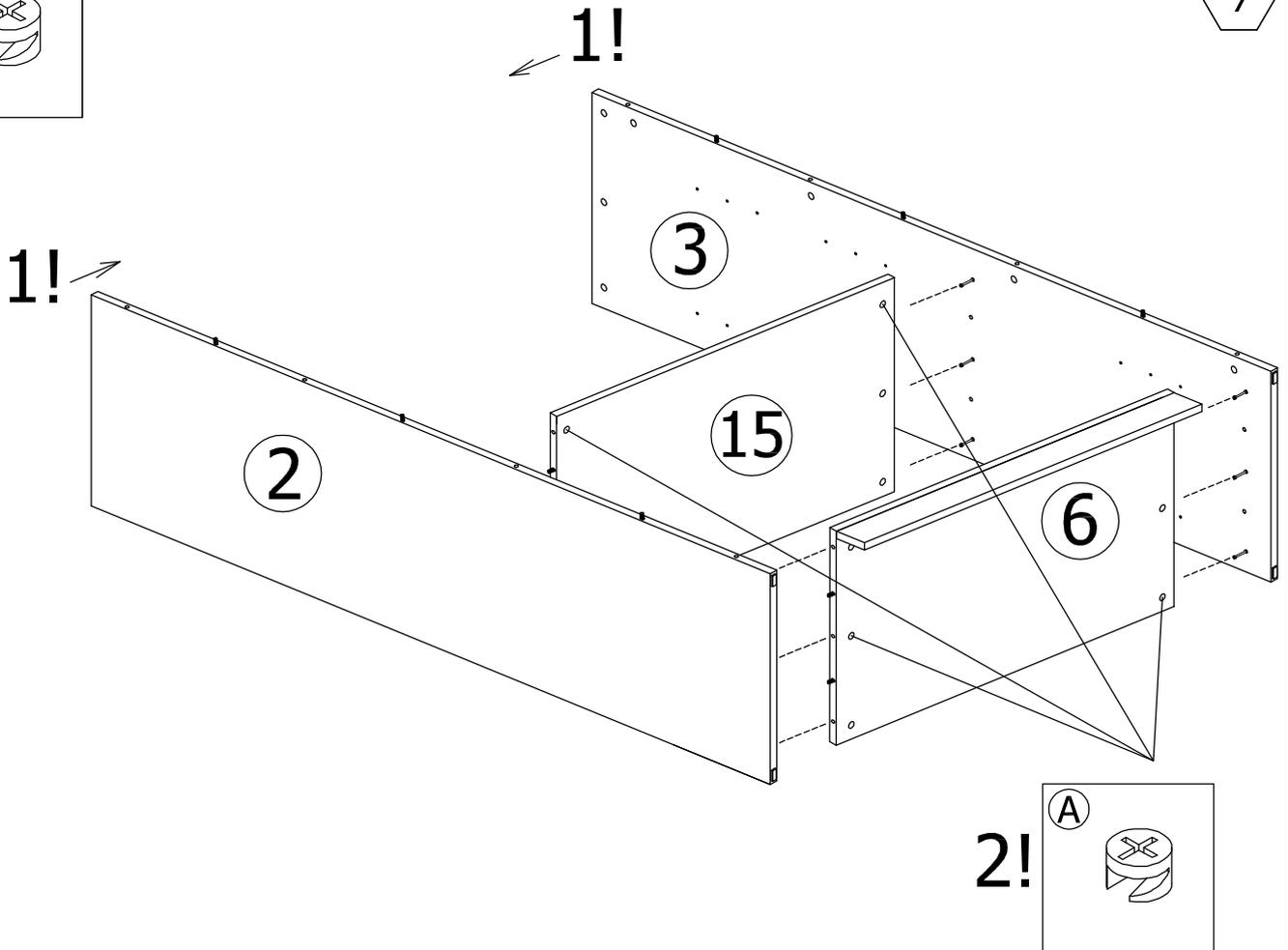

5

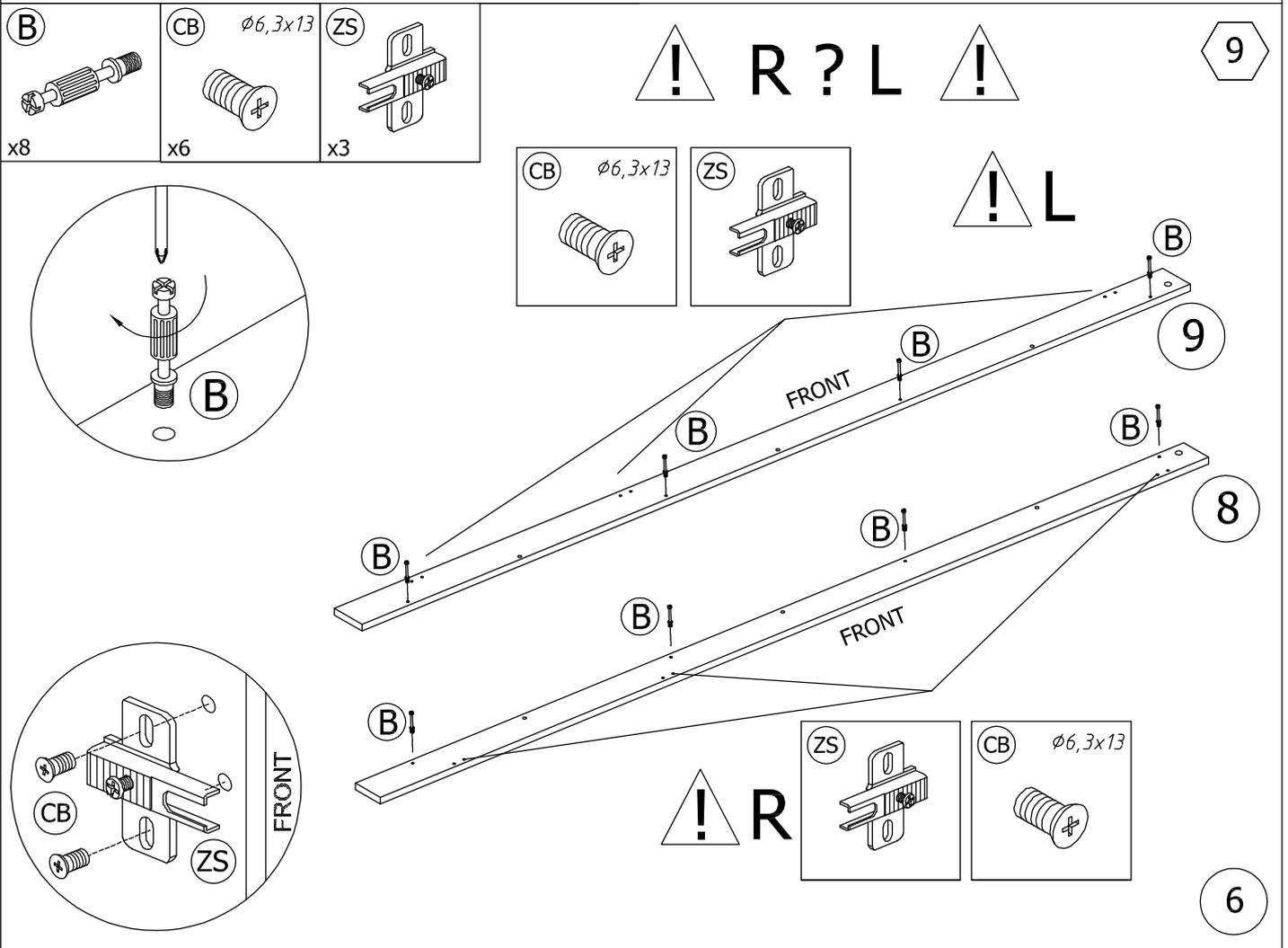
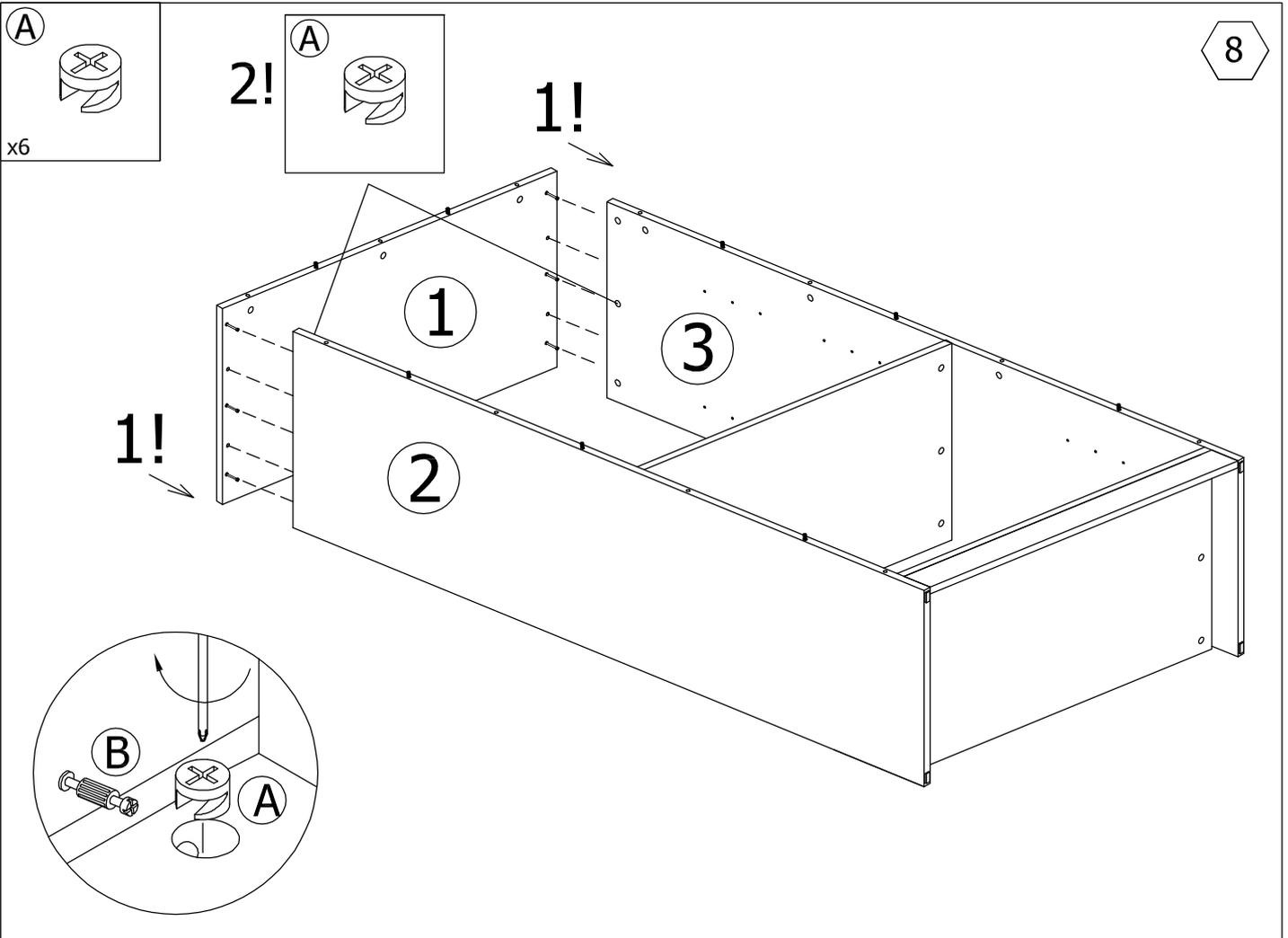

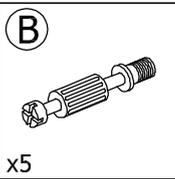

10

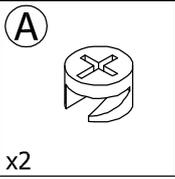
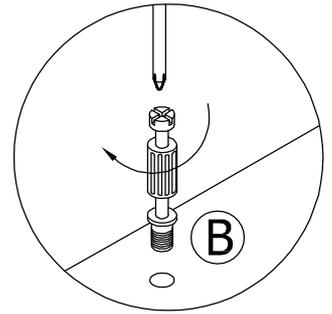
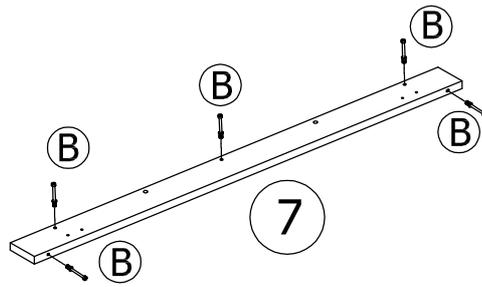

11

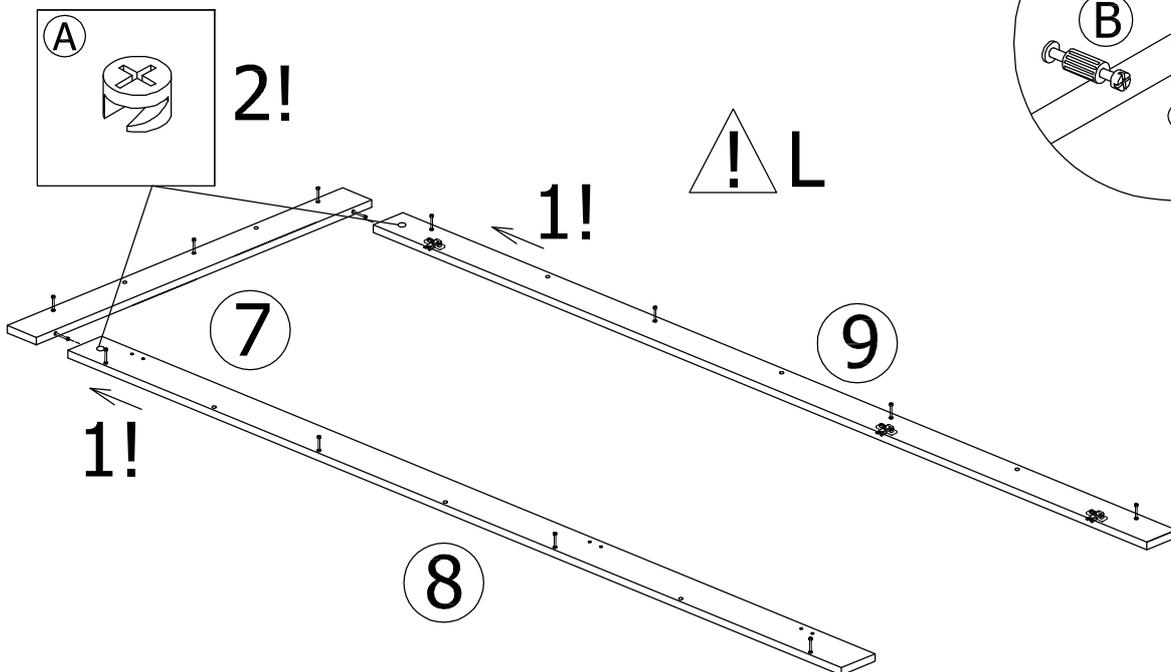
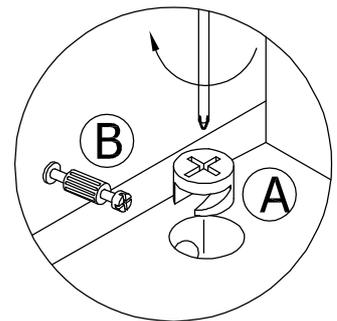
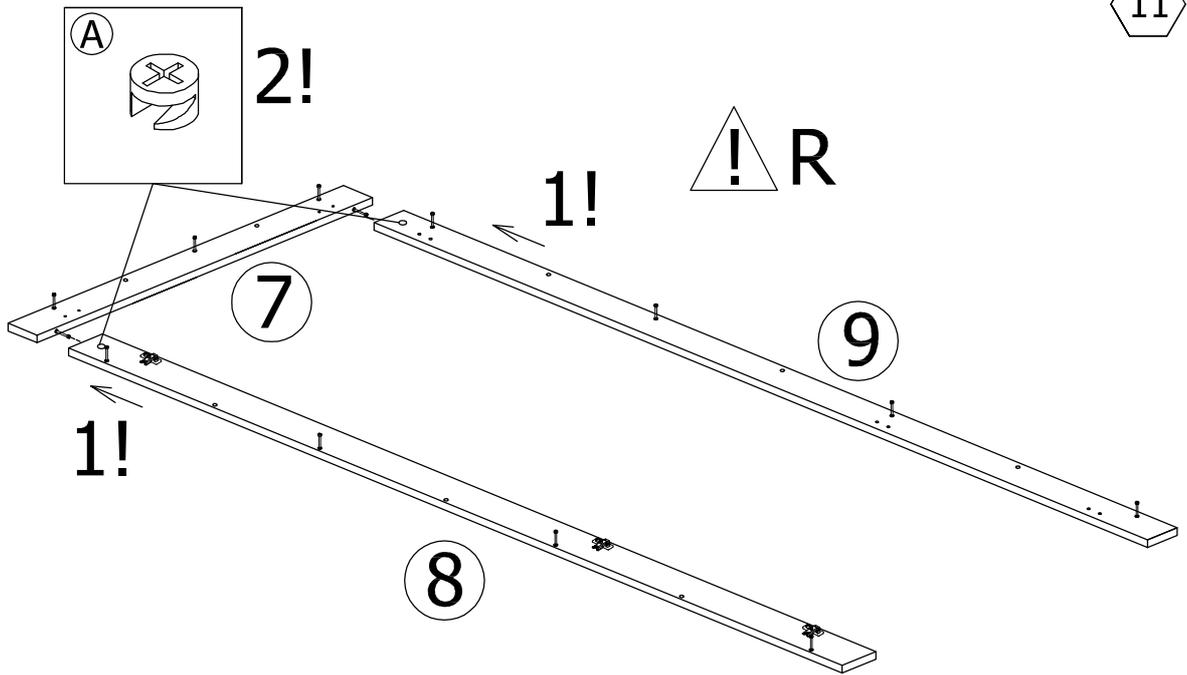

7

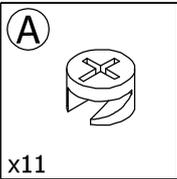

x11

12

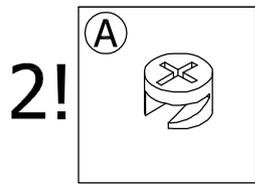

2!

1!

1!

7

8

9

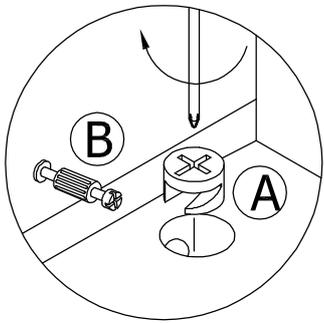

x4

13

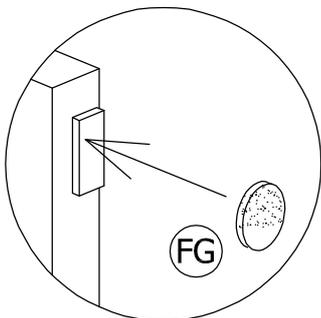
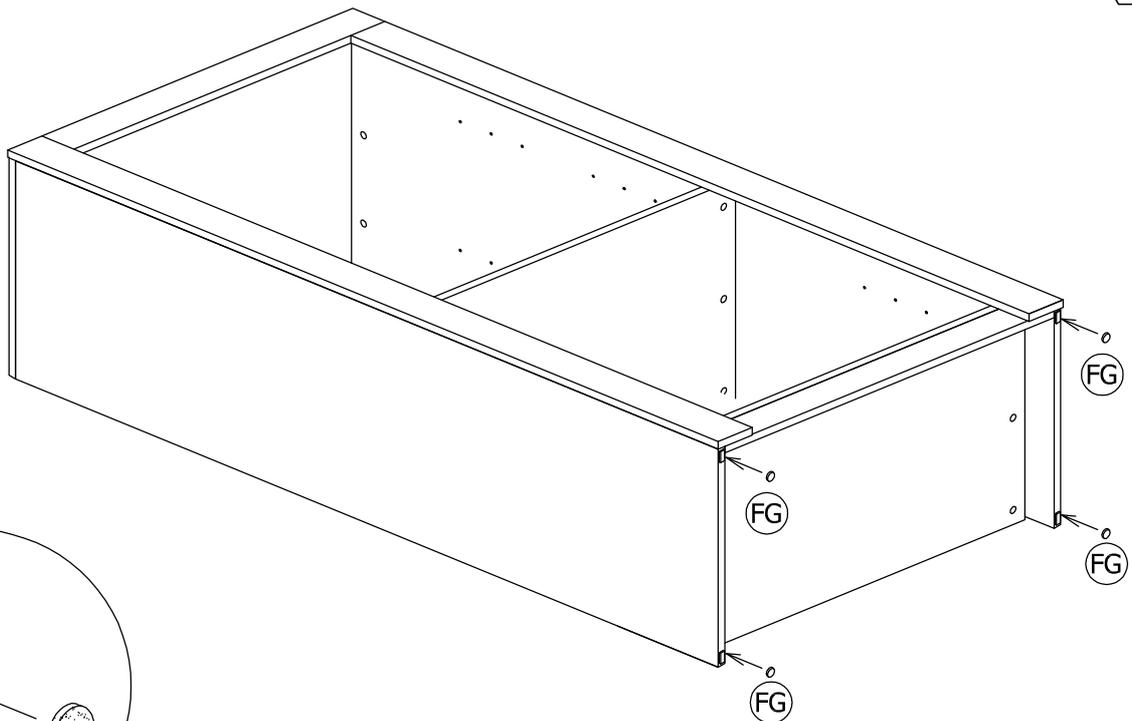

8

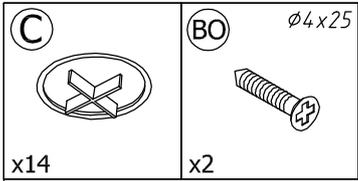

! R ? L !

14

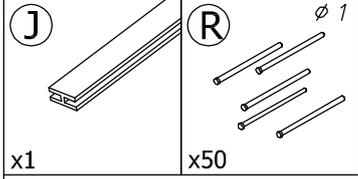
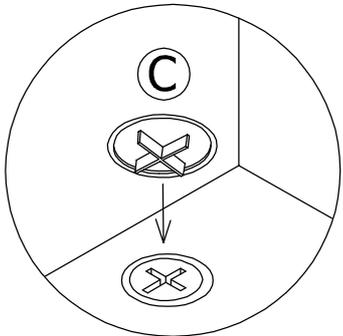
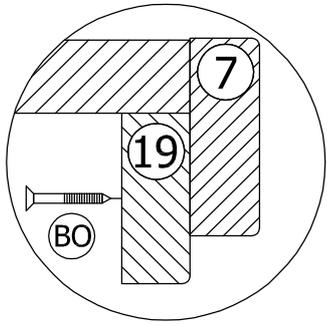
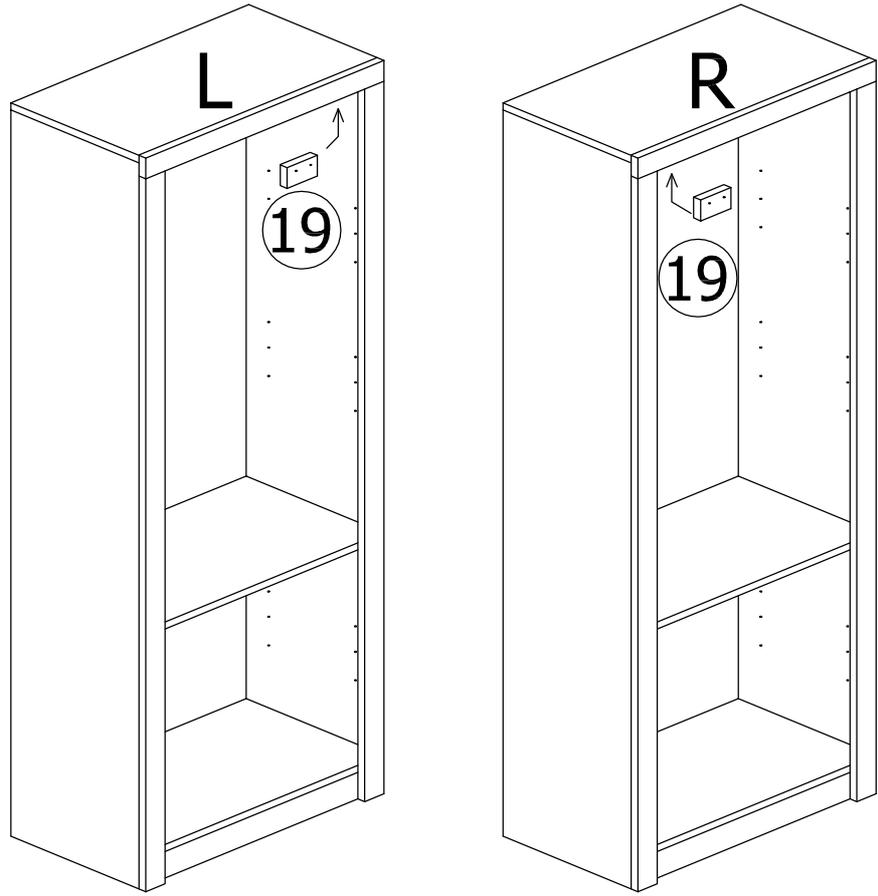

15

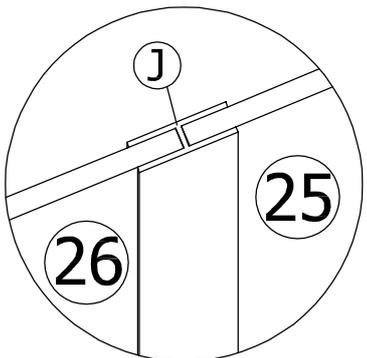
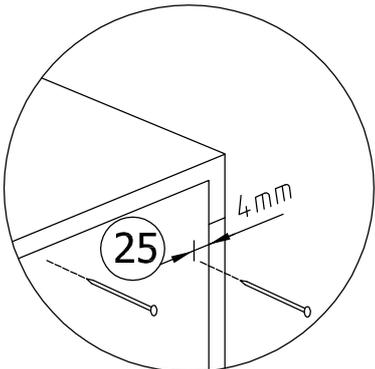
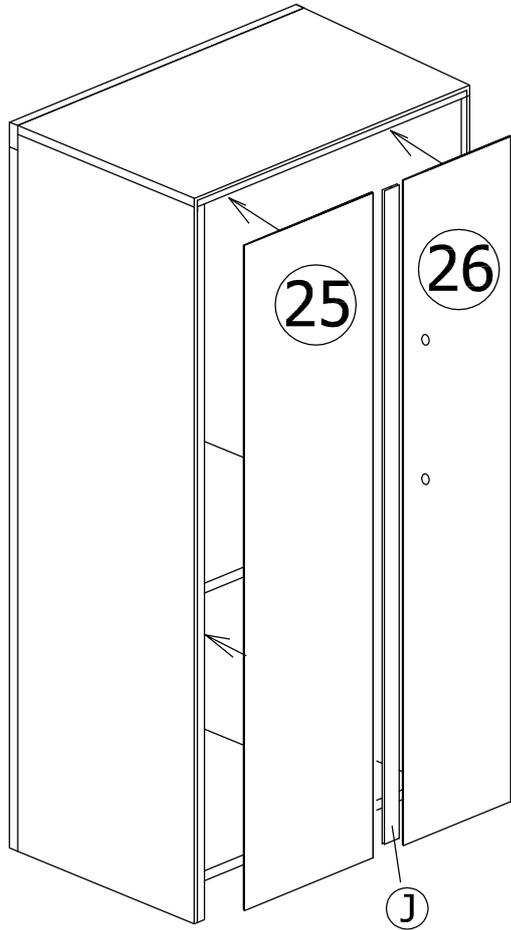

9

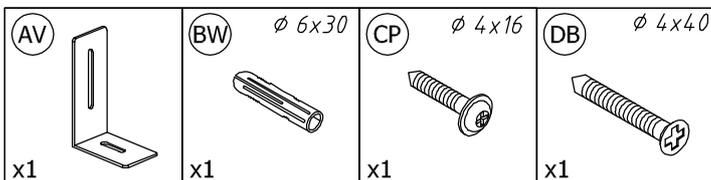

16

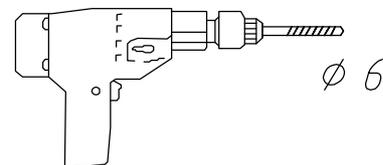
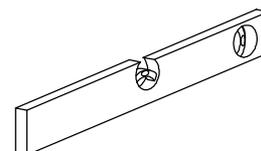
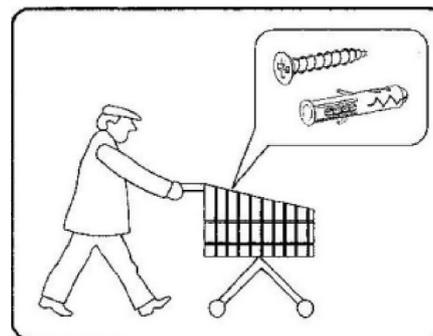
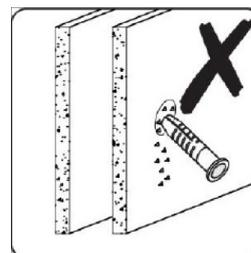
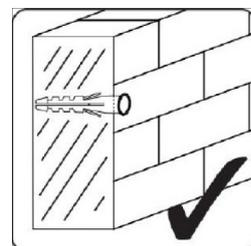
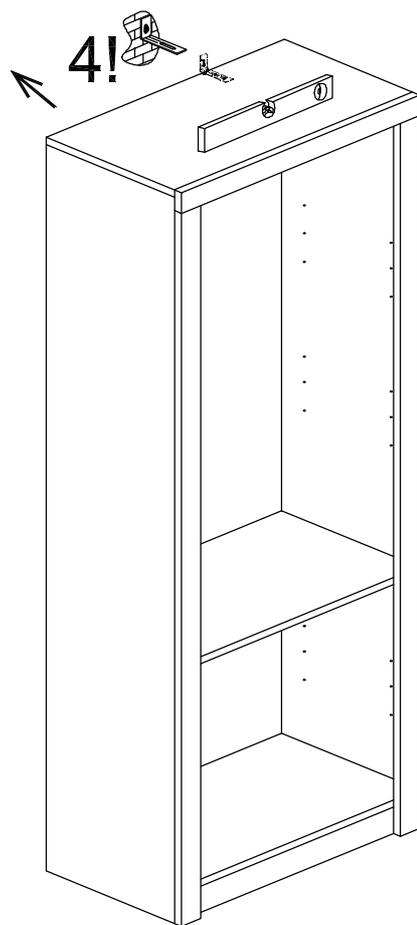
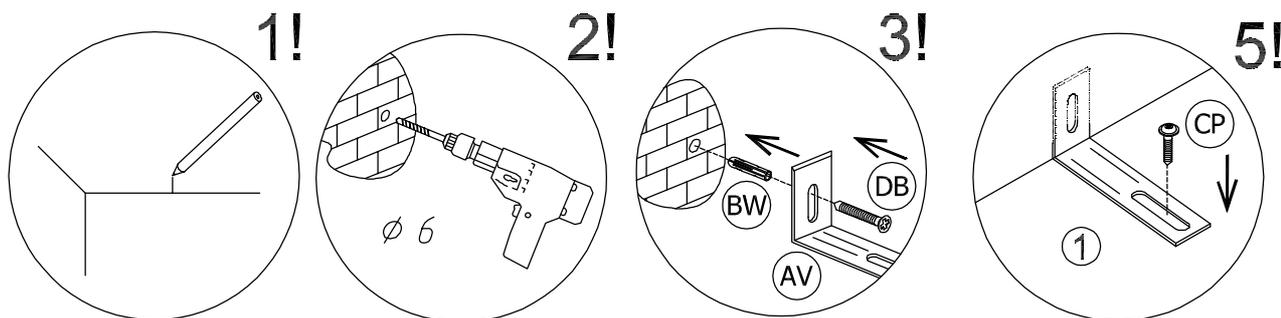

|  Uwaga • Achtung • Attention • Caution • Figyele • Attenzione • Opgelet • Atentie • Upozornenie • Dikkat • Upozornění • Внимание  | |
|--|--|
| (D) | Die Befestigung des Möbelstückes an der Wand muss von einer fachkundigen Person vorgenommen werden, da für die Montage an die Wand angepasste Dübel erforderlich sind. |
| (GB) | A qualified professional is required when mounting furniture to the wall since dowels corresponding to the wall are required for this. |
| (F) | Le montage du meuble au mur peut être fait uniquement par le personnel spécialisé. Il est nécessaire d'utiliser des chevilles bien ajustées pendant le montage au mur. |
| (RO) | Montarea mobilei pe poate fi efectuată numai de către personalul calificat deoarece la această montare se folosesc cepuri. |
| (I) | Attaccare un alla parete può essere effettuato esclusivamente dal personale adatto perché durante il montaggio bisogna usare dei cavicchi adatti. |
| (NL) | een vakkundige persoon dient het meubelstuk aan de muur te bevestigen; voor de montage aan de muur zijn immers aangepaste pluigen vereist |
| (PL) | Mocowanie do ściany może przeprowadzić wyłącznie odpowiedni do tego personel, ponieważ w czasie montażu w ścianie konieczne jest zastosowanie dopasowanych kółków |
| (TR) | Möbilya parçasının duvara sabitlenmesi, duvar montajı için özel uyarlanmış dübeller gerektirdiğinden bu iş sadece bu konuda uzman bir kişi tarafından gerçekleştirilmelidir. |
| (CZ) | Připevnění nábytku ke stěně může uskutečnit výhradně k tomu určený personál, protože pro montáž je nutné použít hmoždinky shodné s typem a tloušťkou stěny. |
| (SK) | Pripínanie nábytku k stene môže uskutočniť výhradne k tomu určený personál, pretože k montáži je nutné použiť hmoždinky zhodné s typom steny a jej hrúbkou |
| (HU) | A bútor a falhoz való rögzítését kizárólag erre illetékes személyzet végezheti, mivel a falhoz való rögzítés során megfelelő méretű csapszeg alkalmazása szükséges. |
| (RU) | Очищайте от пыли тряпкой или слегка влажной ветошью. Не допускается применение чистящих средств, не предназначенных для ухода за мебелью. |

10

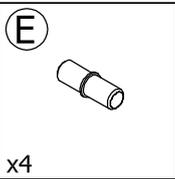

17

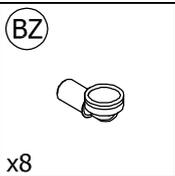
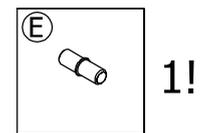
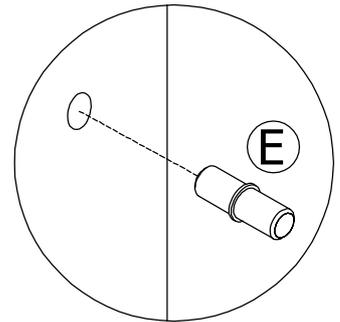
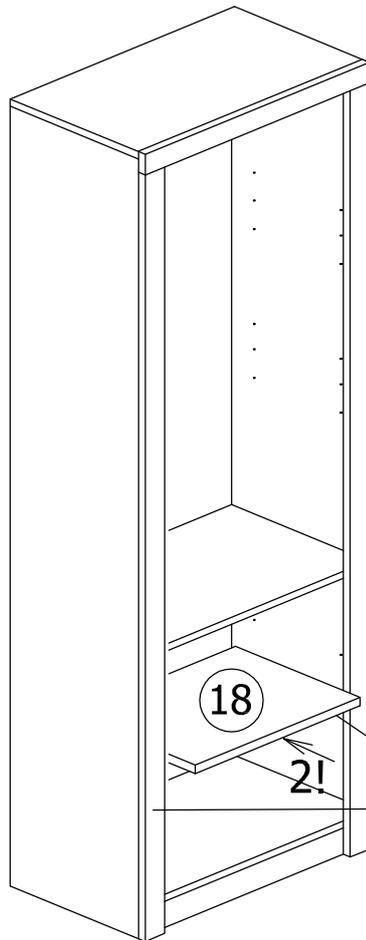

18

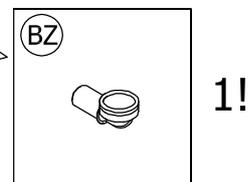
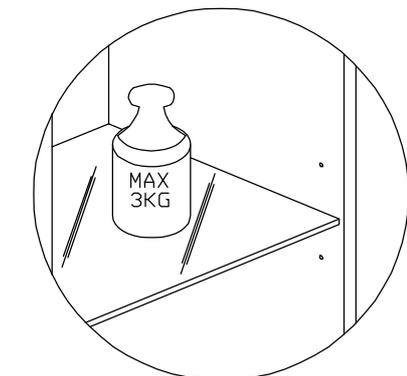
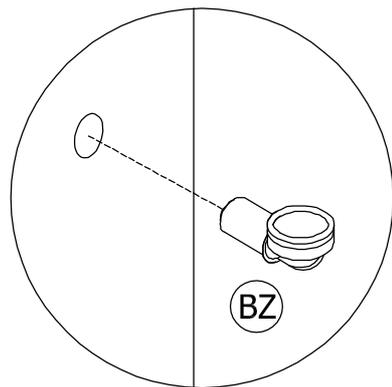
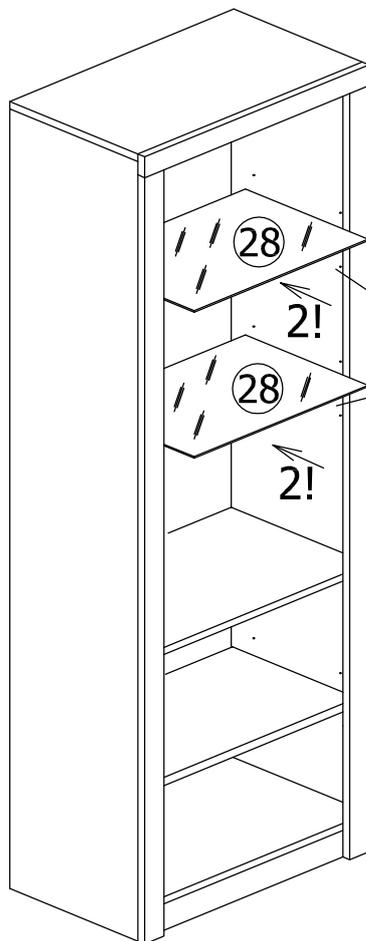

11

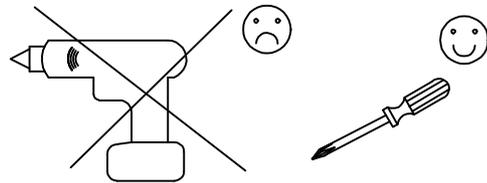
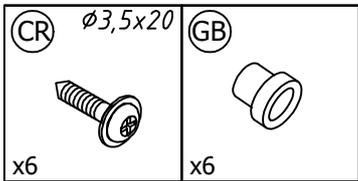

19

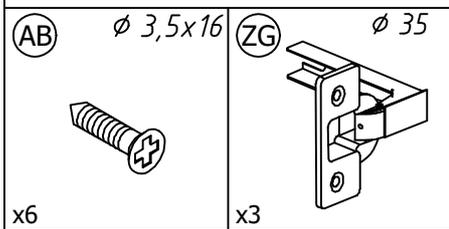
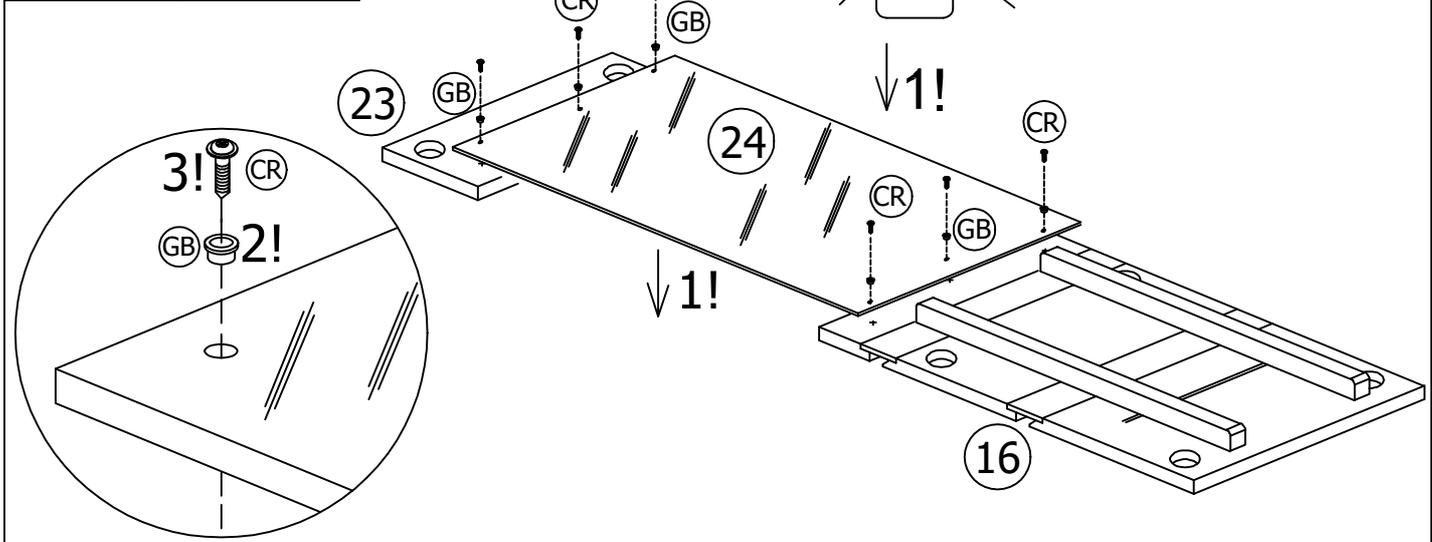

! R ? L !

20

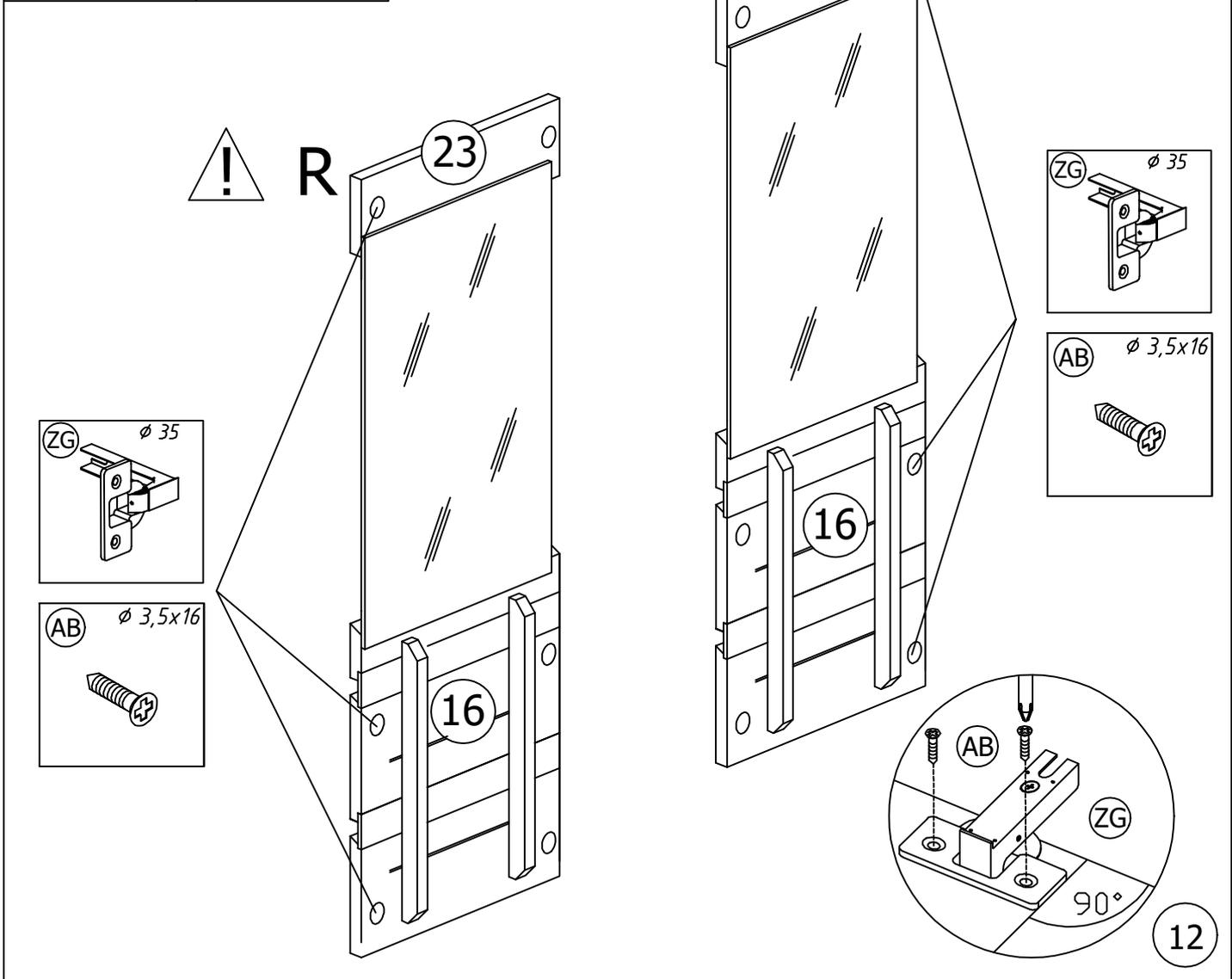

12

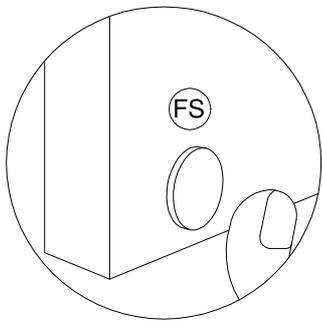
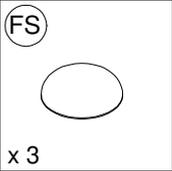

! R ? L !

21

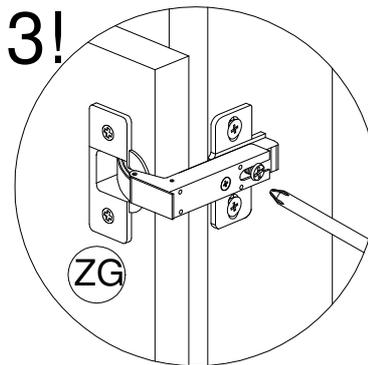
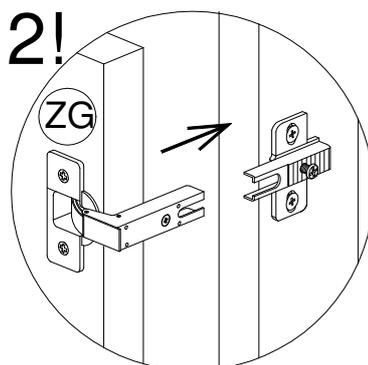
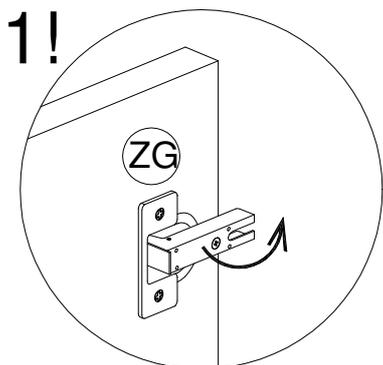
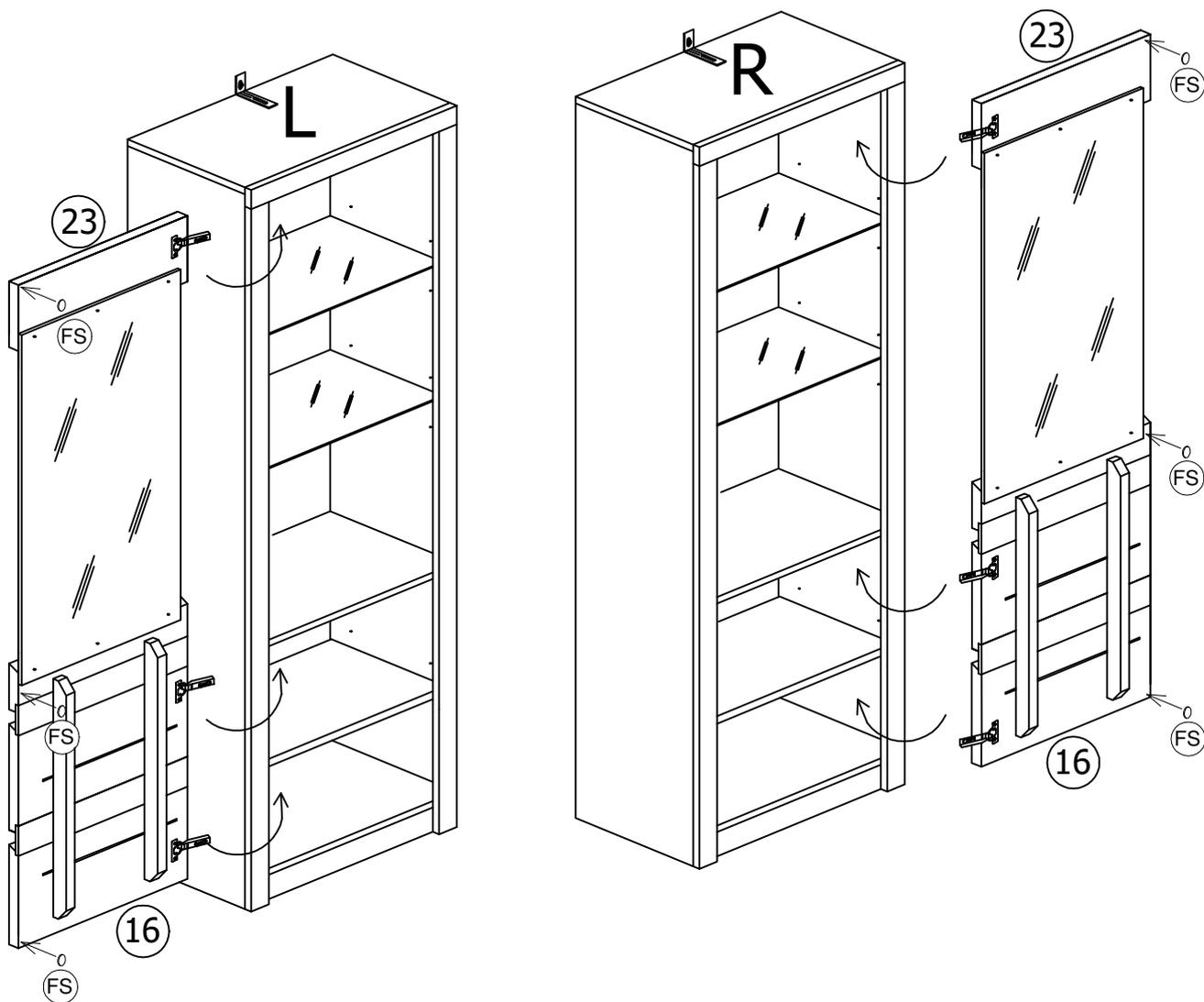

13

ZG

∅ 35

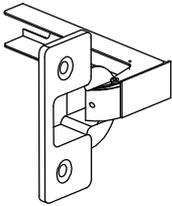

(D) Turen einstellen (Scharniere justieren)

(GB) Adjusting the doors (adjusting the hinges)

(F) Mettre la porte (égaliser les gonds)

(RO) Ajustați ușa (aliniați balamalele)

(I) Regolare la porta (livellare le parentesi)

(NL) Deuren instellen (scharnieren afstellen)

(PL) Nastawić drzwi (wyrównać zawiasy)

(TR) Kapıların ayarlanması (menteşelerin seviye ayarı)

(CZ) Seříd'te dveře (vyrovnajte závěsy)

(SK) Zrad'te dvere (vyrovnajte závesy)

(HU) Állítsa be az ajtó (igazítsa be a zsanérokot)

(RU) Регулировка дверей (регулировка шарнира)

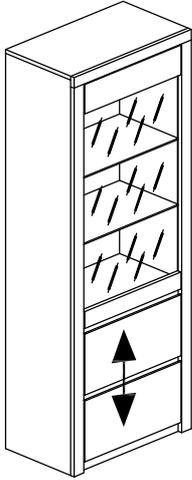

1!

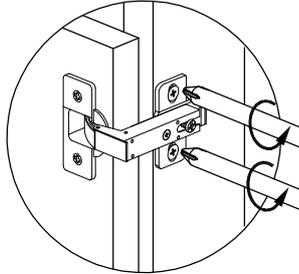

2!

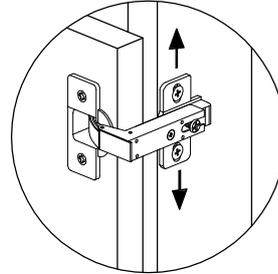

3!

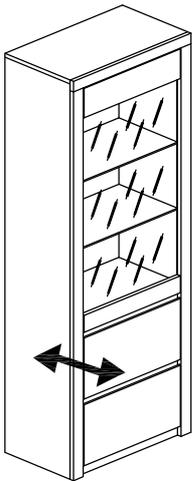
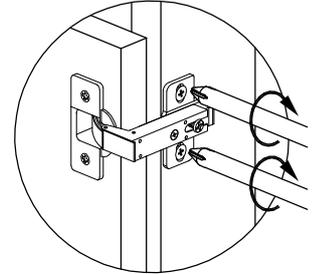

1!

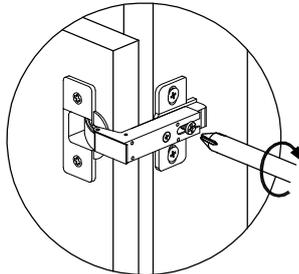

2!

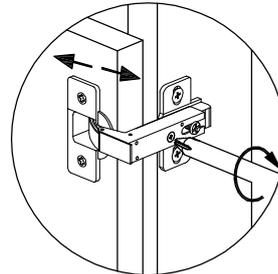

3!

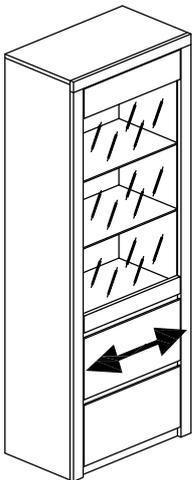
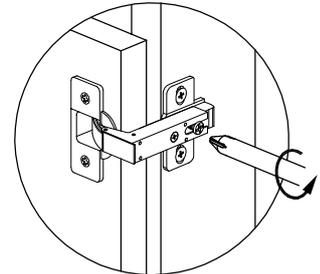

1!

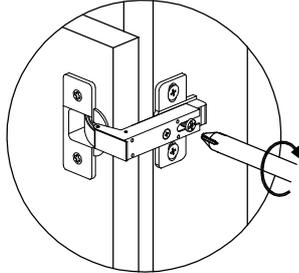

2!

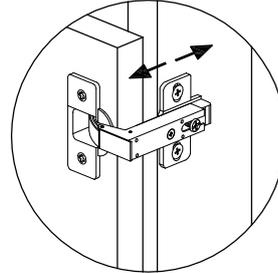

3!

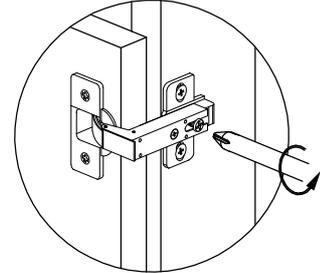

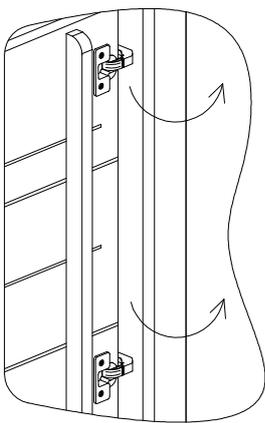
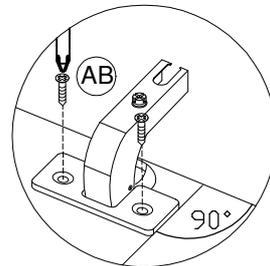
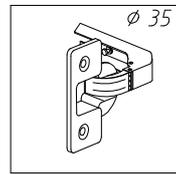
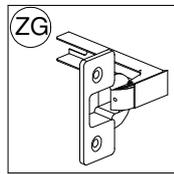
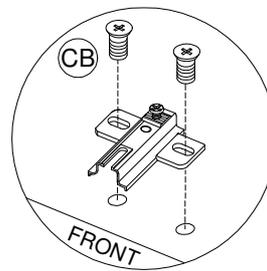
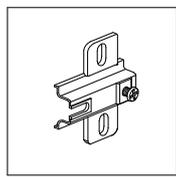
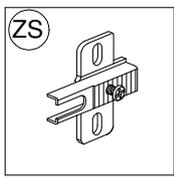

1!

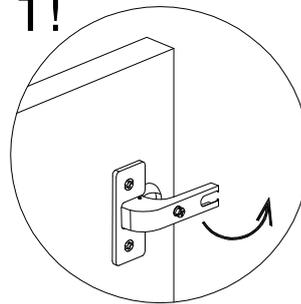

2!

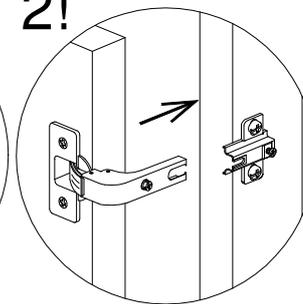

3!

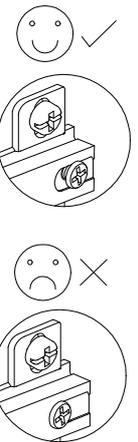
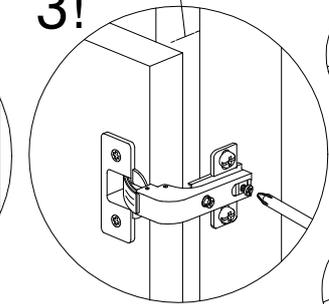

(D) Turen einstellen (Scharniere justieren)

(GB) Adjusting the doors (adjusting the hinges)

(F) Mettre la porte (égaliser les gonds)

(RO) Ajustați ușa (aliniați balamalele)

(PL) Nastawić drzwi (wyrównać zawiasy)

(TR) Kapıların ayarlanması (menteşelerin seviye ayarı)

(CZ) Seřídít dveře (vyrovnajte závěsy)

(SK) Zradít dveře (vyrovnajte závesy)

(I) Regolare la porta (livellare le parentesi)

(NL) Deuren instellen (scharnieren afstellen)

(HU) Állítsa be az ajtó (igazítsa be a zsanérokot)

(RU) Регулировка дверей (регулировка шарнира)

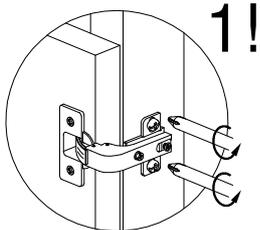

1!

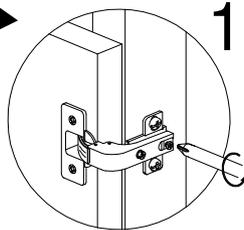

1!

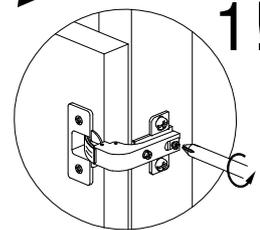

1!

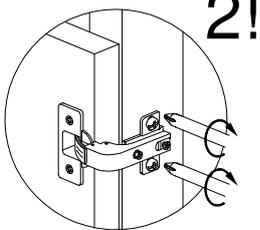

2!

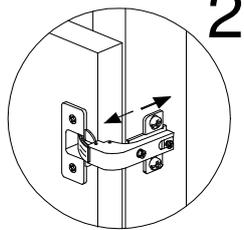

2!

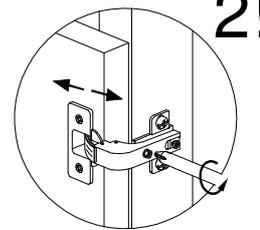

2!

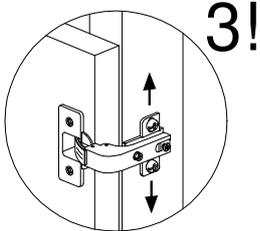

3!

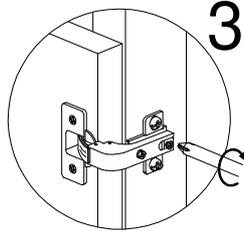

3!

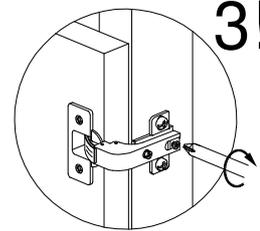

3!

(D) Montageanleitung

(I) Istruzioni di montaggio

(CZ) Montážní návod

LKZ 41194

(GB) Assembly instructions

(NL) Handleiding voor de montage

(SK) Návod na montáž

(F) Notice de montage

(PL) Instrukcja montażu

(HU) Szerelési útmutató

(RO) Instrucțiuni de montaj

(TR) Montaj talimatı

(RU) Инструкция по монтажу



SILKEBORG SI-43

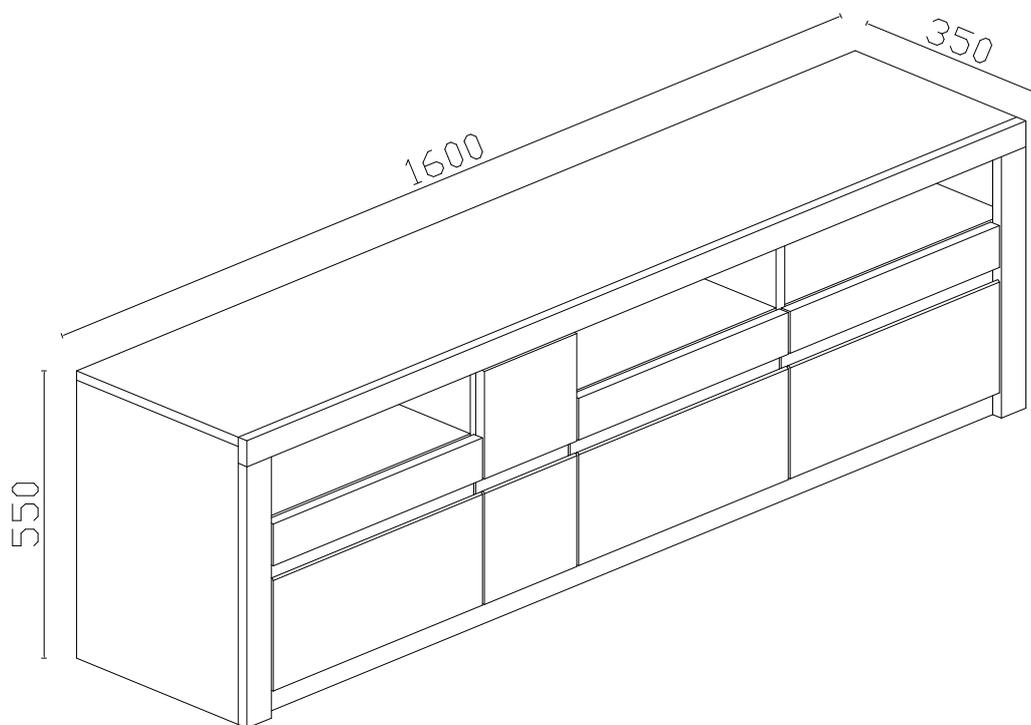

! Uwaga • Achtung • Attention • Caution • Figyele • Attenzione • Opgelet
Atentje • Upozornenie • Dikkat • Upozornění • Внимание **!**

(D) Bitte nur mit einem Staubtuch oder leicht feuchtem Lappen reinigen.
Keine scheuernden Putzmittel verwenden

(GB) Please only with a duster or a damp cloth.
Do not use any abrasive cleaners

(F) Le nettoyage se fait uniquement à l'aide d'un torchon ou d'une serviette
légèrement mouillée

(RO) Curățarea trebuie efectuată numai o cârpă sau cu un prosop ușor umezit
Nu utilizați agenți de curățare abrazivi

(I) Pulire esclusivamente con un panno o un asciugamano umido

(NL) Reinig alleen met een stofdoek of een lichtjes vochtige doek
Gebruik geen schurende poetsmiddelen

(PL) Czyszczenie należy wykonać wyłącznie za pomocą ściereczki lub lekko nawilżonego
ręcznika. Nie stosować środków czyszczących do szorowania

(TR) Lütfen sadece bir toz bezilye veya hafif nemli yumuşak bir bezle siliniz.
Aşındırıcı temizlik malzemeleri kullanmayınız

(CZ) Čistění je nutné vykonávat výhradně pomoci utěrky nebo lehce navlhčeného ručníku.
Nepoužívejte čističské prostředky obsahující abrazivní částice

(SK) Čistenie je nutné vykonávať výhradne pomoci utierky alebo ľahko zvlhnutým ručníkom
Nepoužívajte čistiace prostriedky obsahujúce abrazívne častice

(HU) A tisztítás kizárólag törleruha vagy enyhén nedvesített törölköző segítségével végezhető.
Súroló hatású tisztítószereket nem szabad használni

(RU) Очищайте от пыли тряпкой или слегка влажной ветошью. Не допускается применение
чистящих средств, не предназначенных для ухода за мебелью.

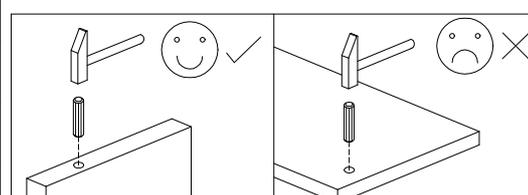
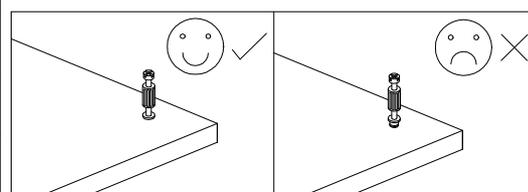
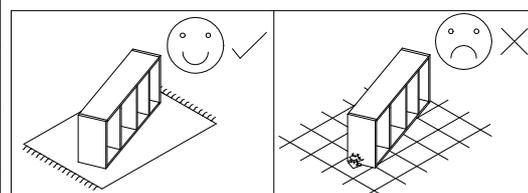
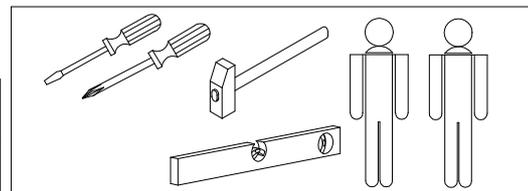

(D) Servicekarte

(RO) Carte de service

(PL) Karta serwisowa

(SK) Služobný preukaz

(GB) Service card

(I) Carta di servizio

(TR) Servis karti

(HU) Szerviz kártya

(F) Carte de service

(NL) Dienst kaart

(CZ) Servisni karta

(RU) Сервисная карта

SILKEBORG SI-43

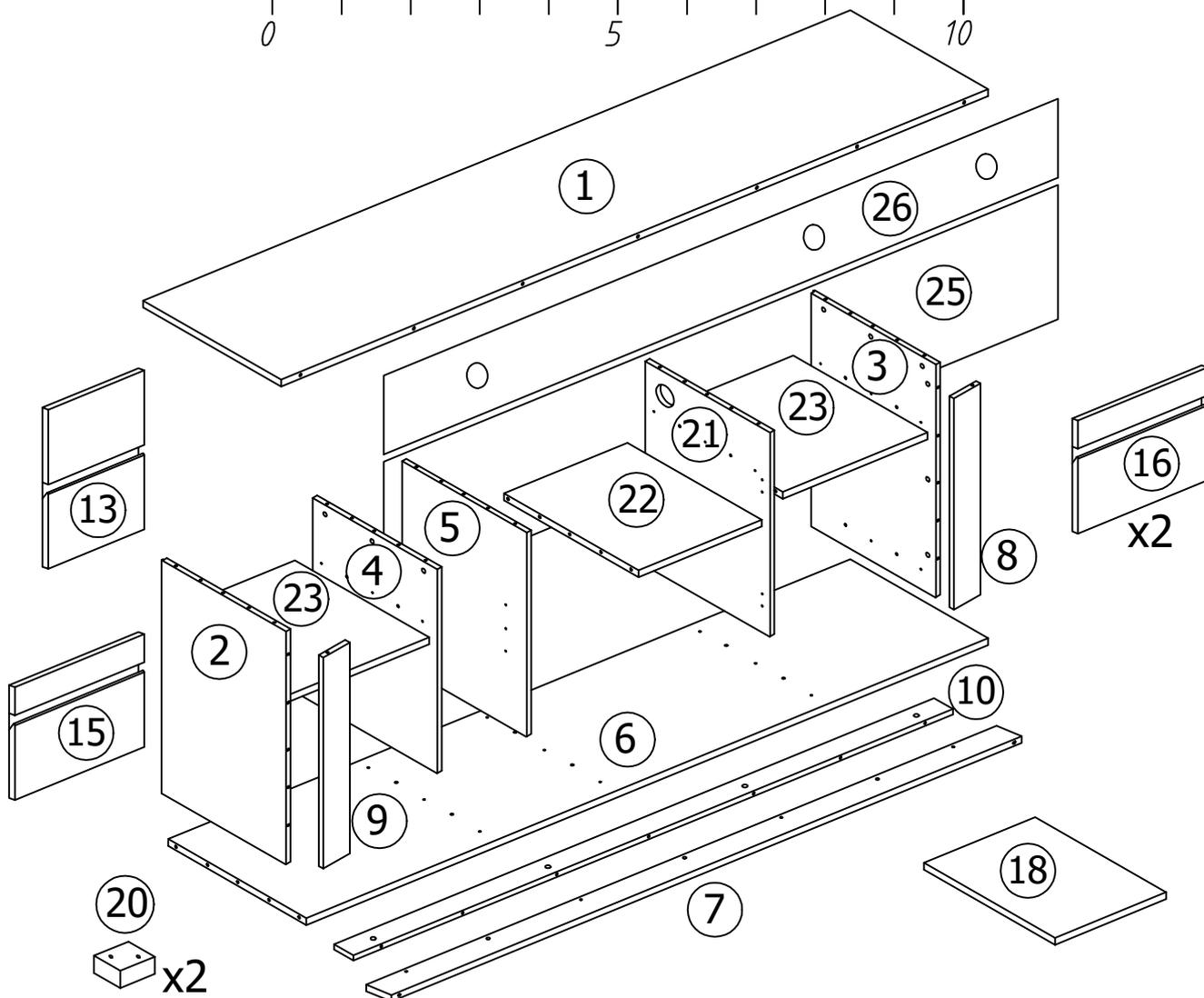
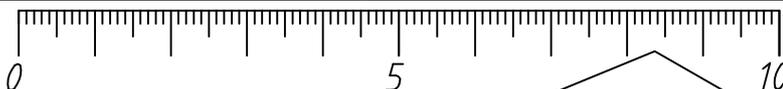
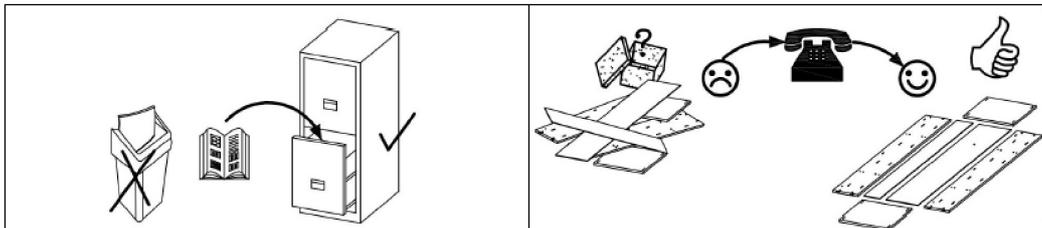

| | | | | | | | | |
|-------------------------------|----------|-----------|-------------------------------|----------------------------|----------|----------|-------------------|--|
| (A) x55 | (B) x49 | (C) x21 | (D) $\phi 8$ x42 | (E) x4 | (K) x1 | (N) x9 | (R) $\phi 1$ x50 | |
| (AB) $\phi 3,5 \times 16$ x16 | (AC) x3 | (AO) x15 | (CB) $\phi 6,3 \times 13$ x16 | (DB) $\phi 4 \times 40$ x4 | (FG) x6 | (FS) x8 | (ZB) $\phi 35$ x4 | |
| (ZG) $\phi 35$ x4 | (ZP) x4 | (ZS) x4 | | | | | | |

B

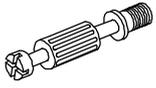

x15

D

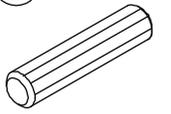

x12

1

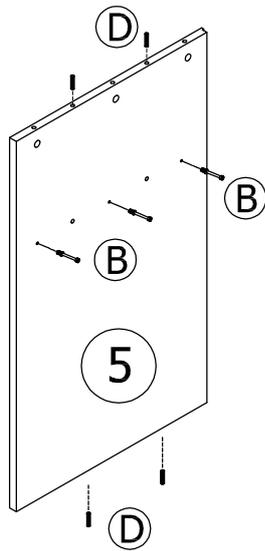
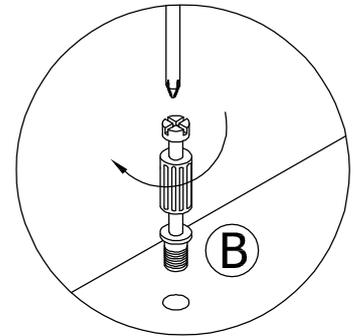
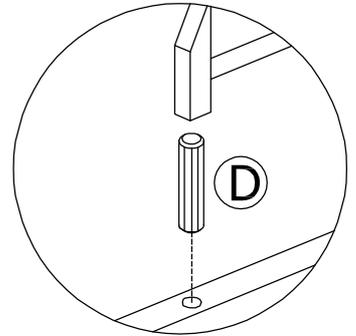
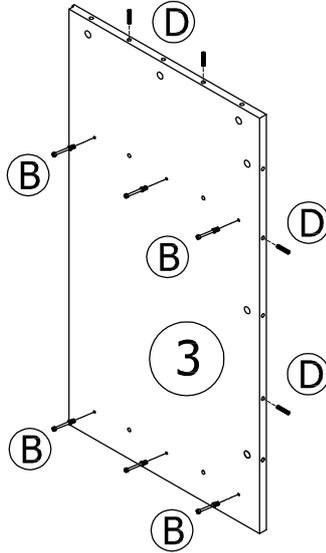
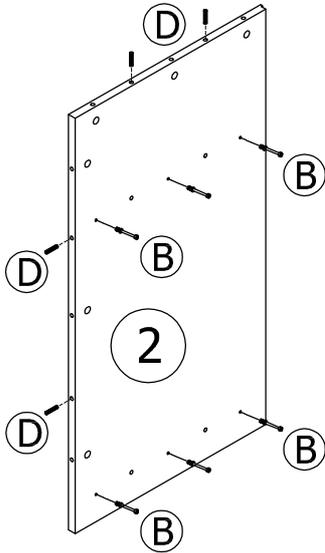

3

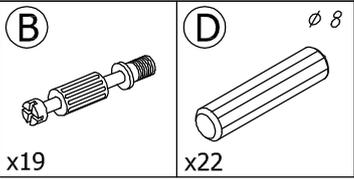

2

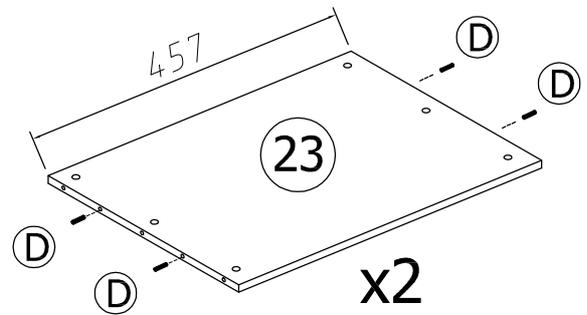
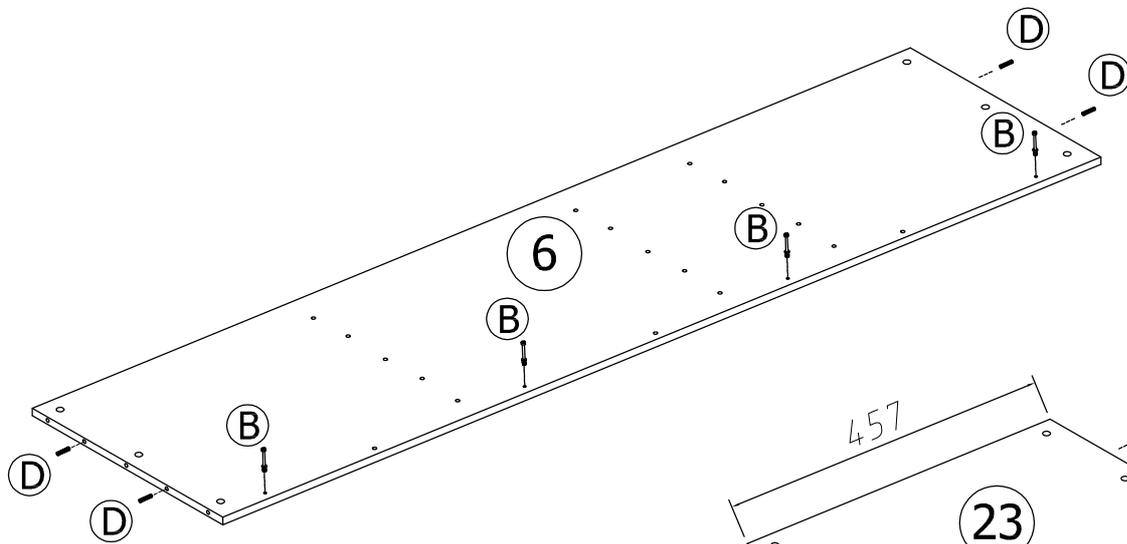
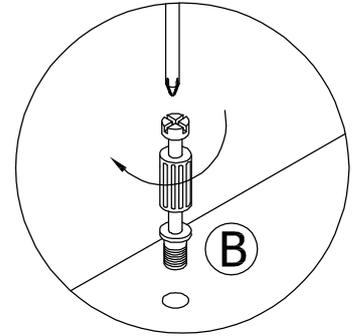
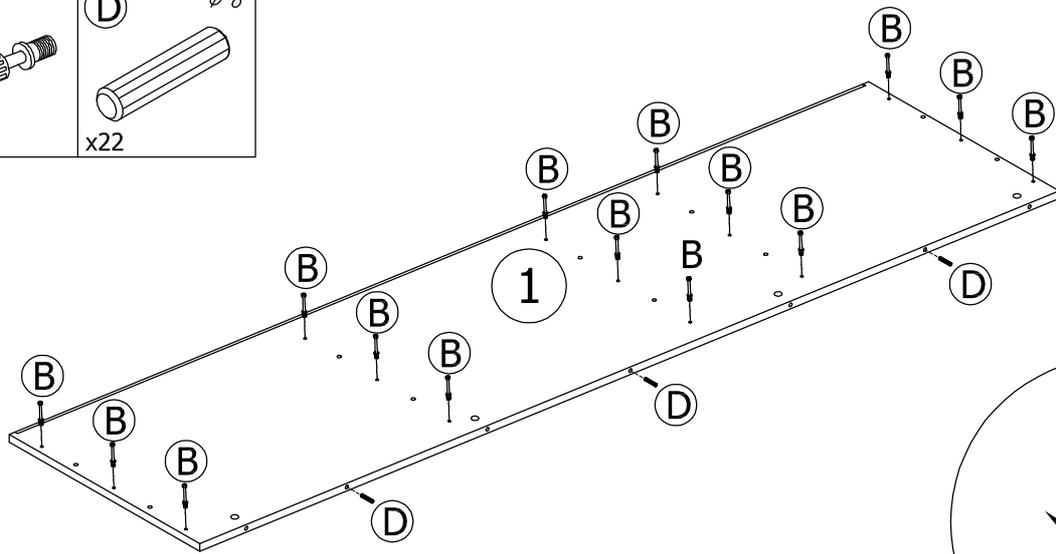

x2

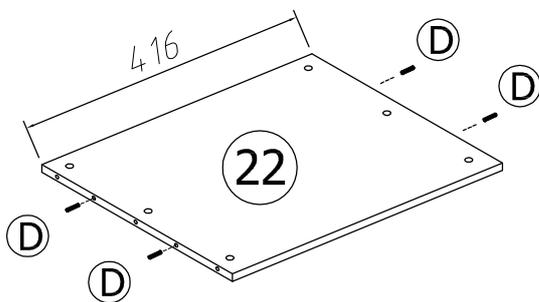

10

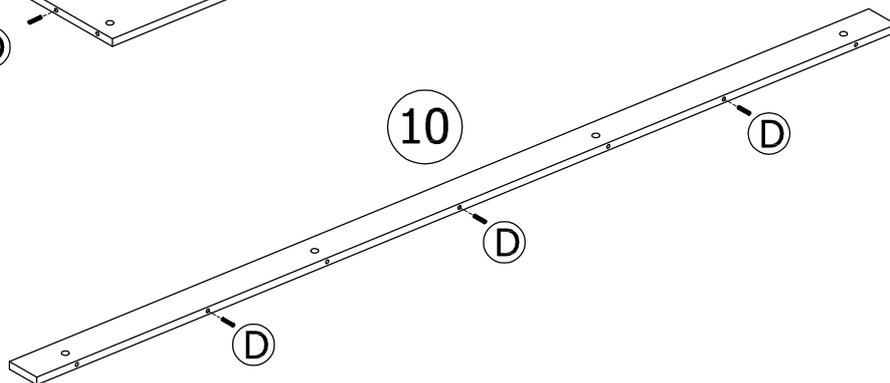

4

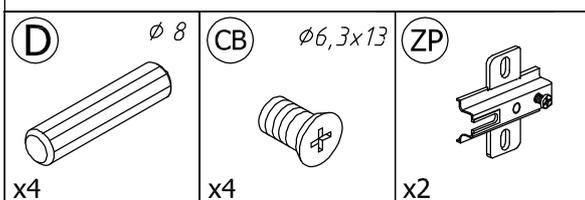
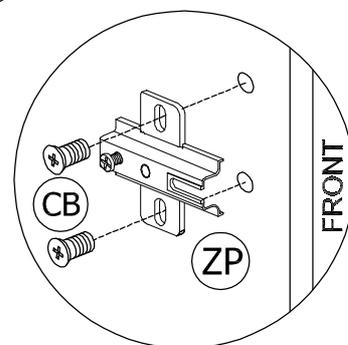
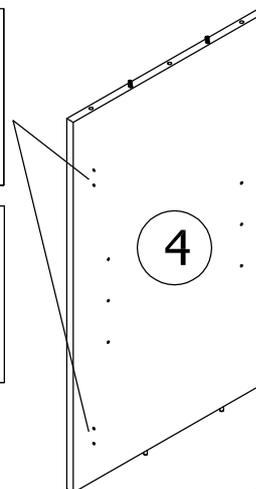
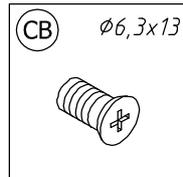
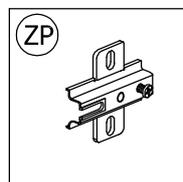
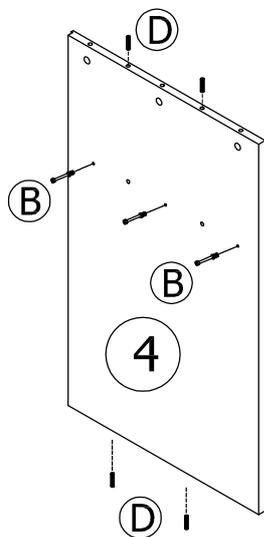
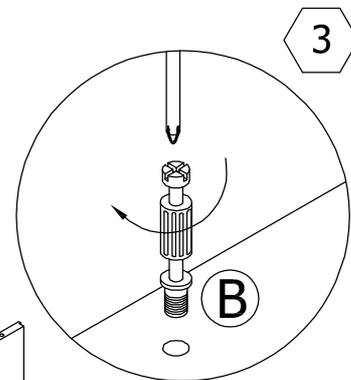
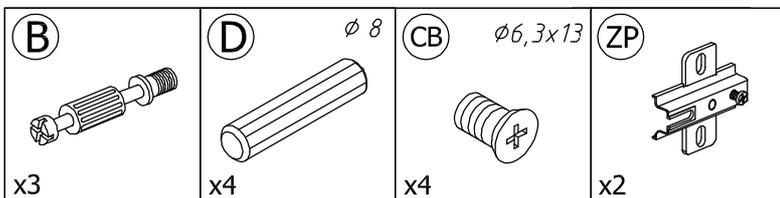

4

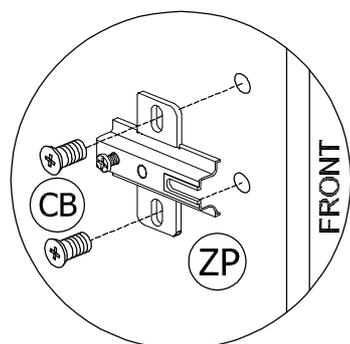
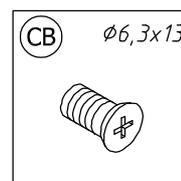
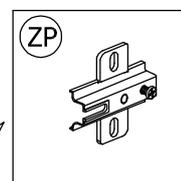
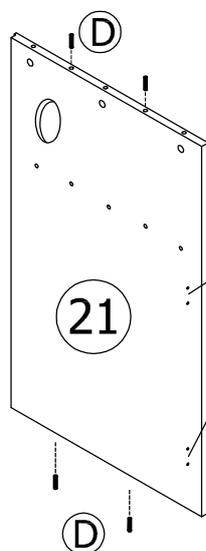

5

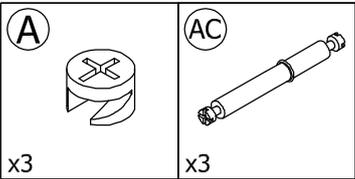

5

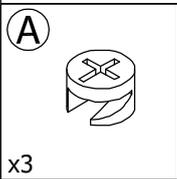
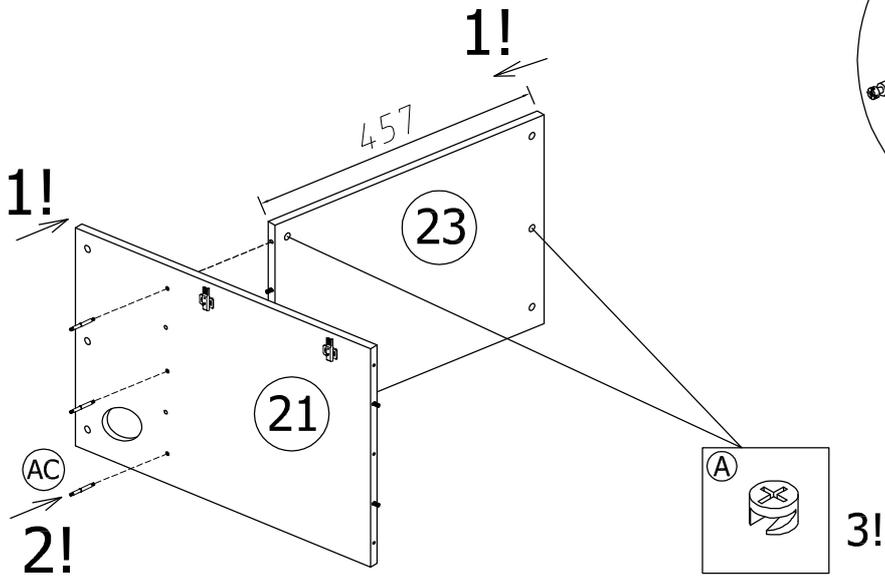

6

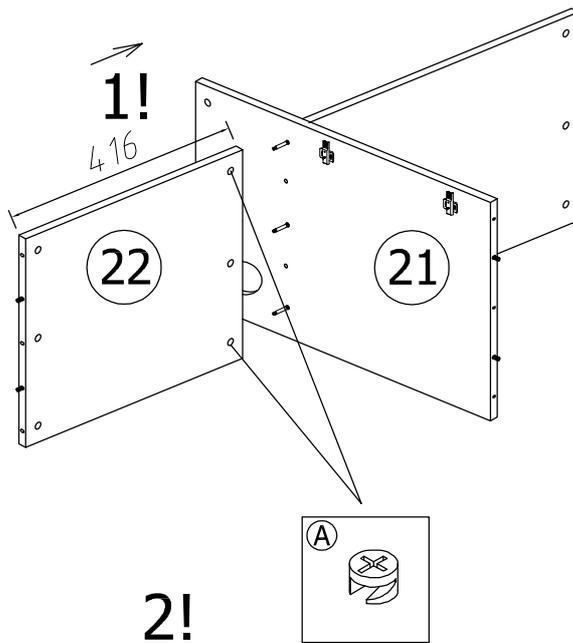

6

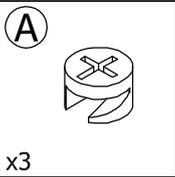

7

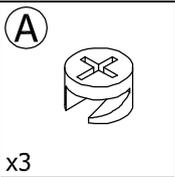
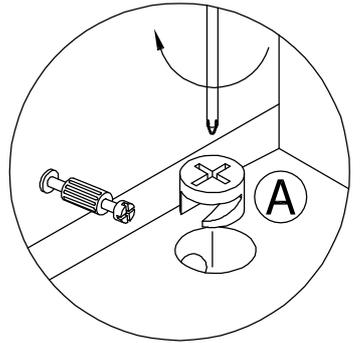
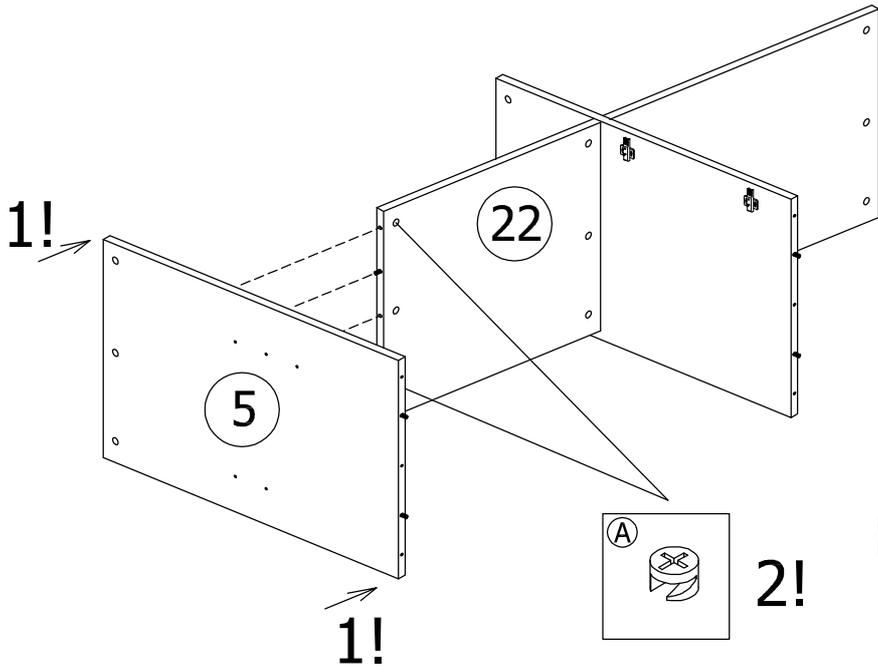

8

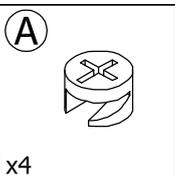
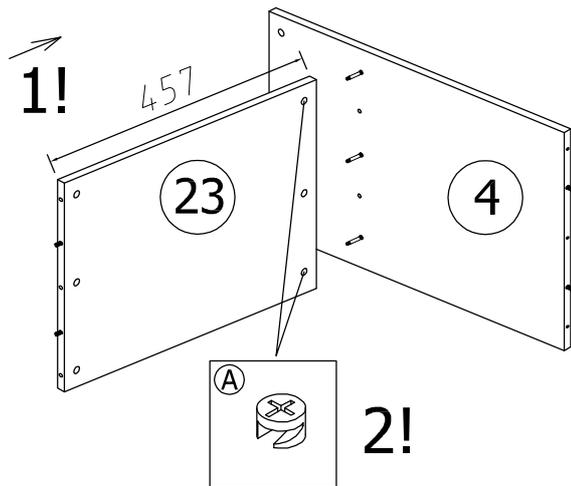

9

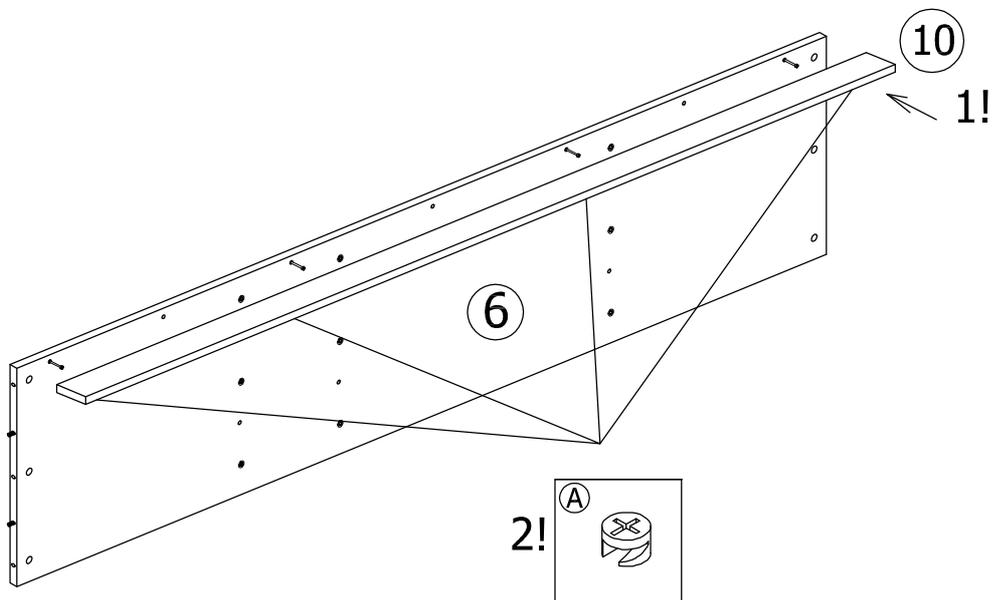

7

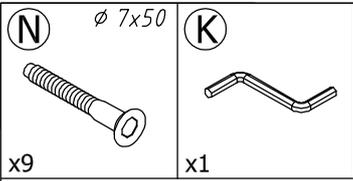

10

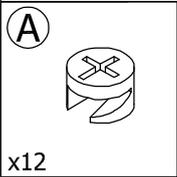
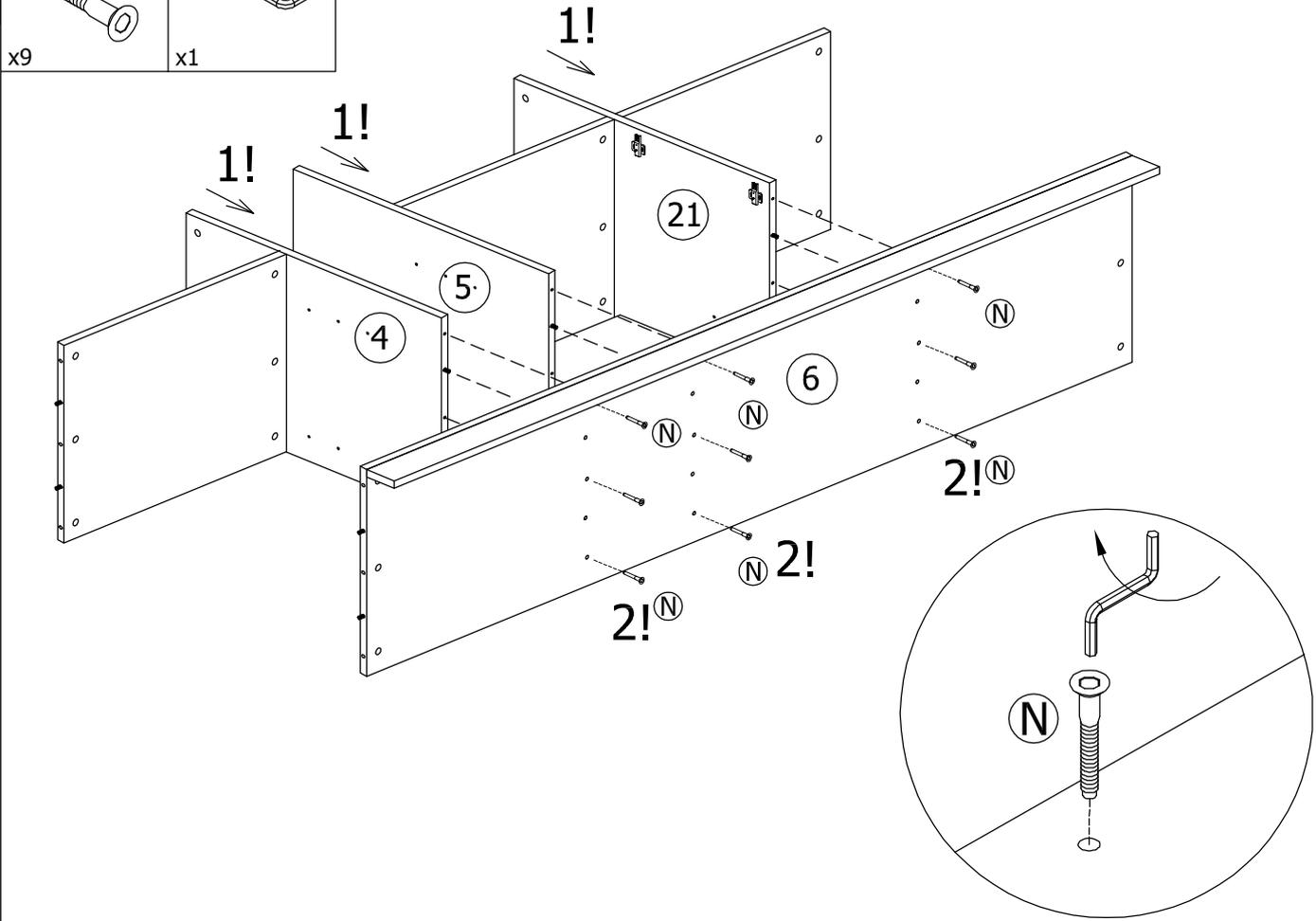

11

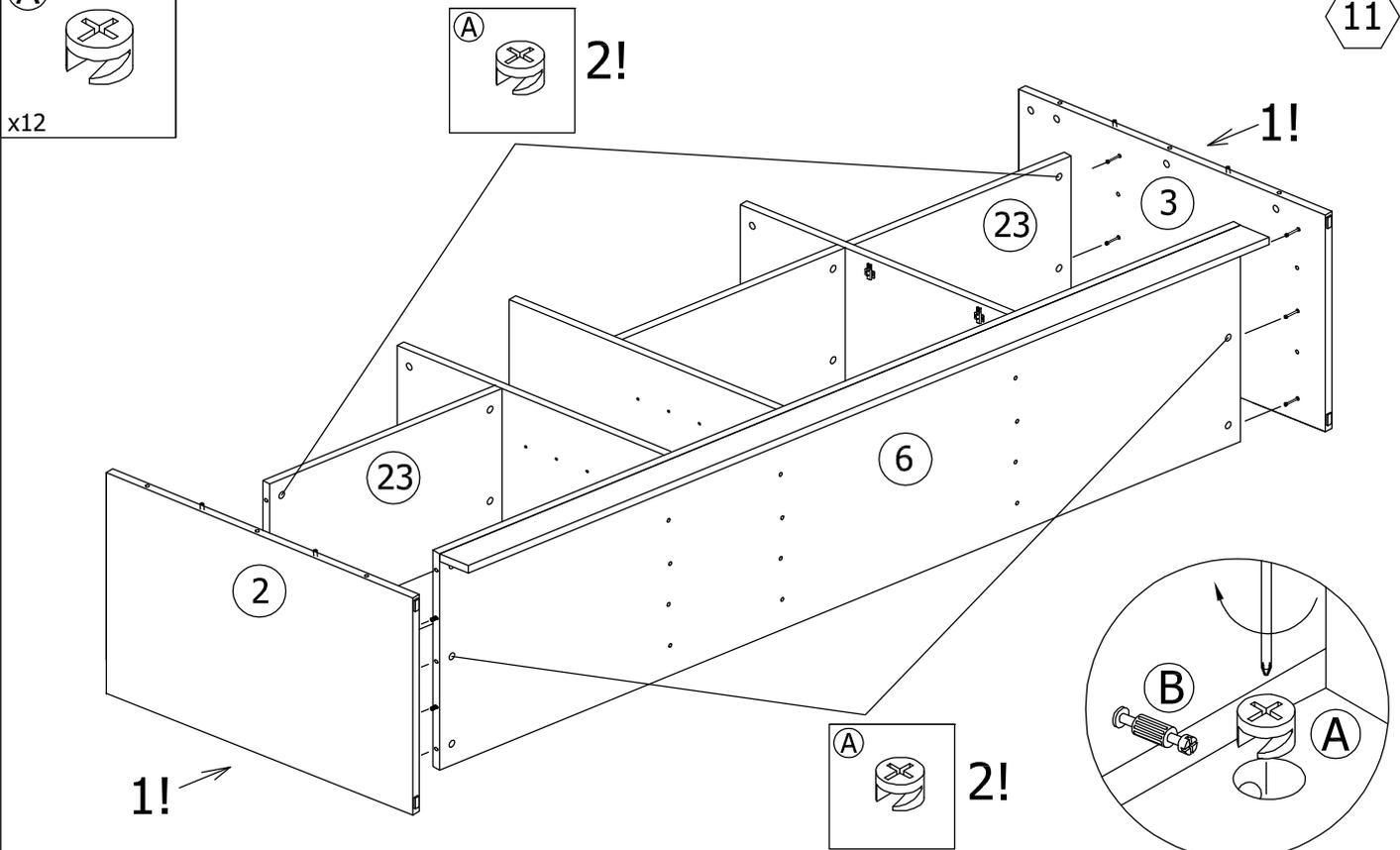

8

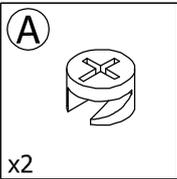

14

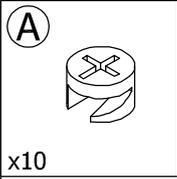
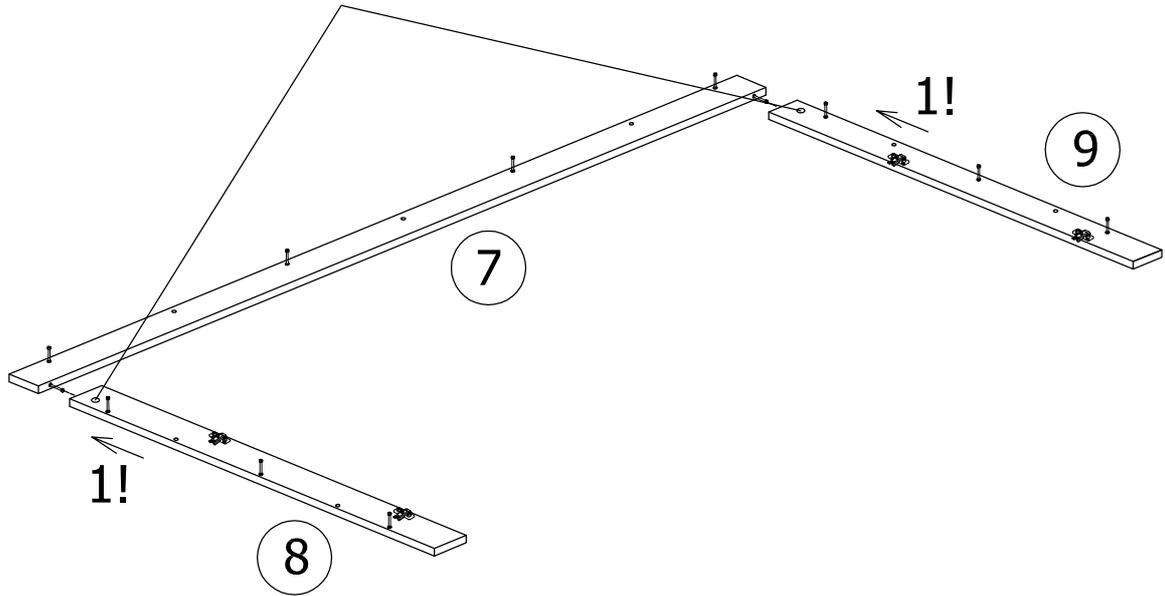
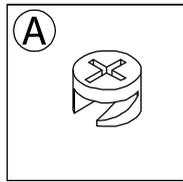

15

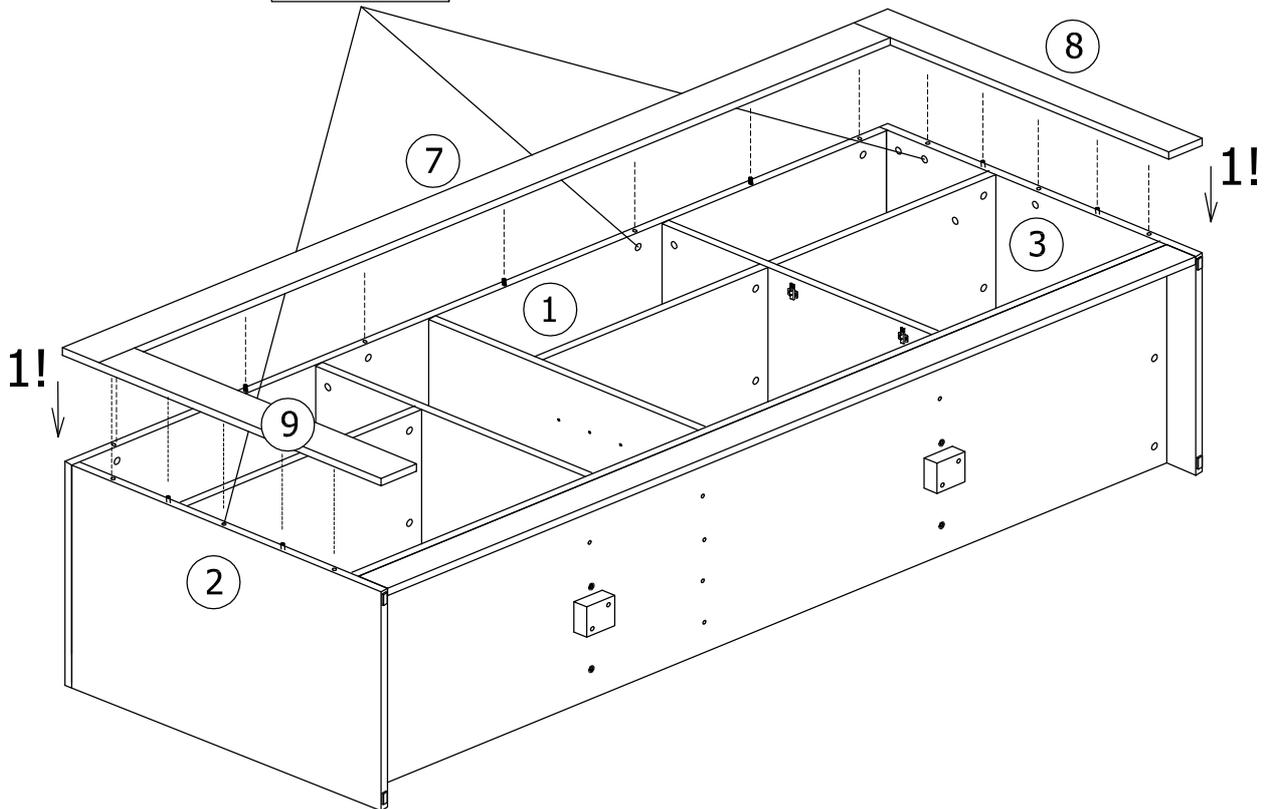
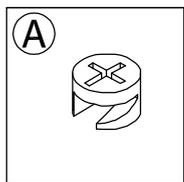

10

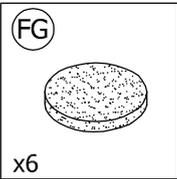

16

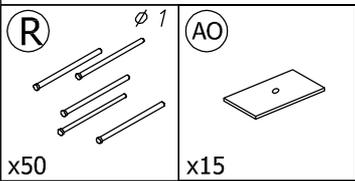
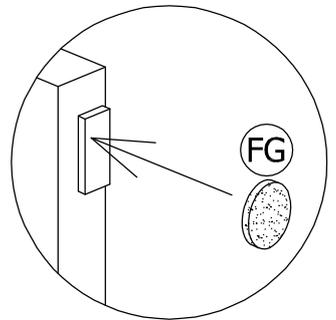
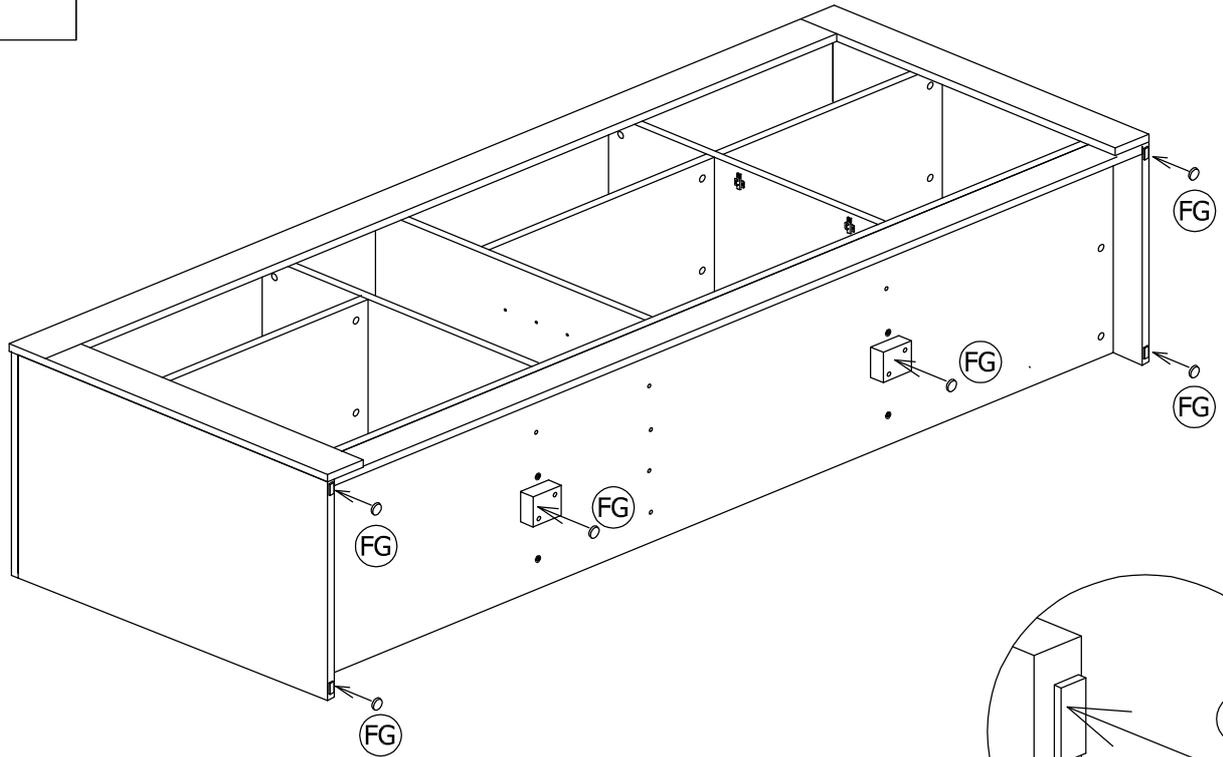

17

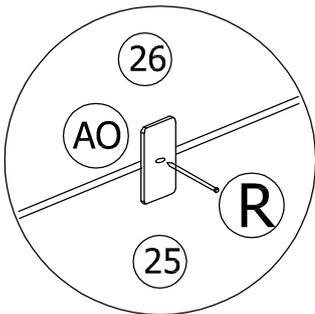
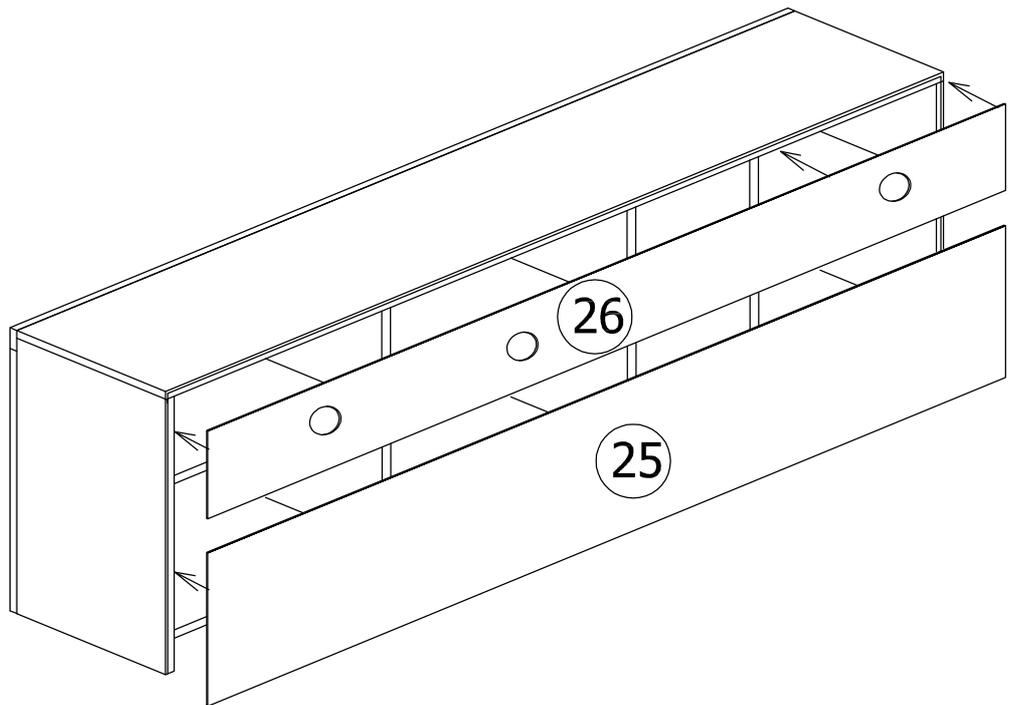
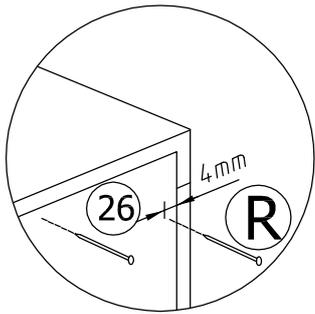

11

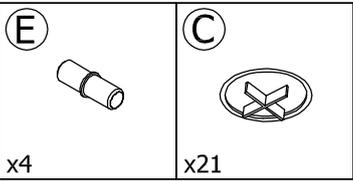

18

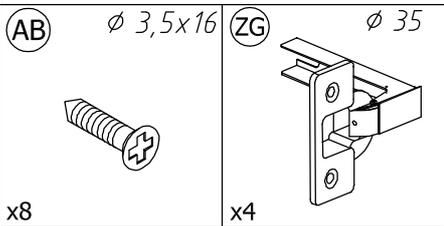
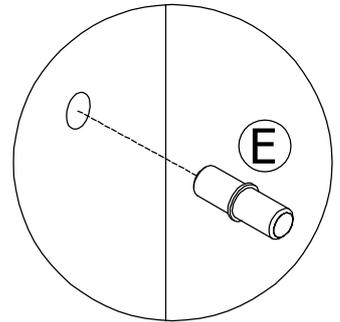
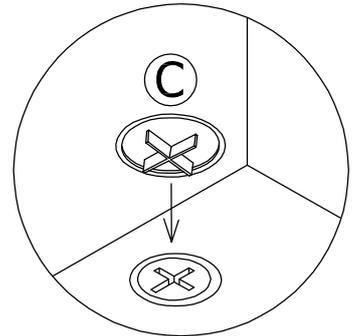
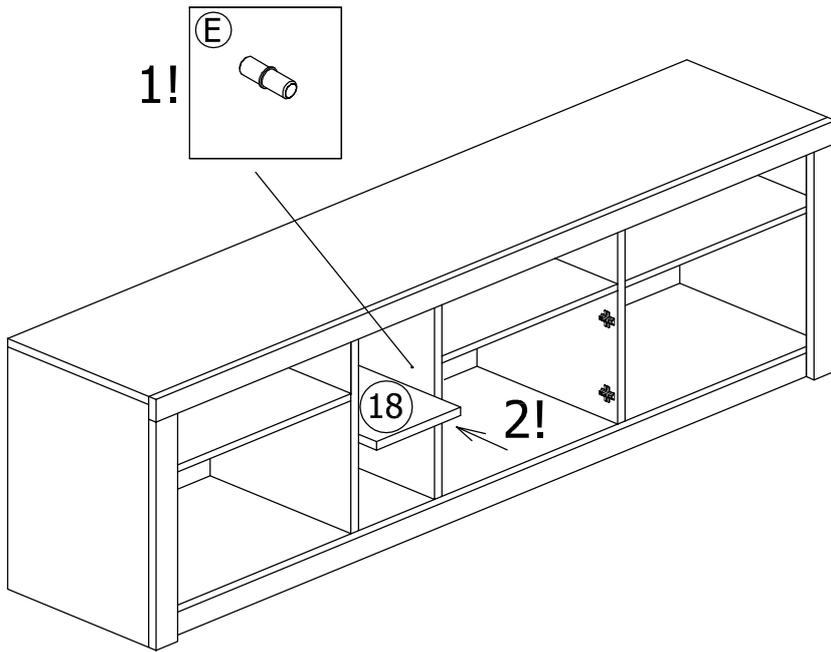

19

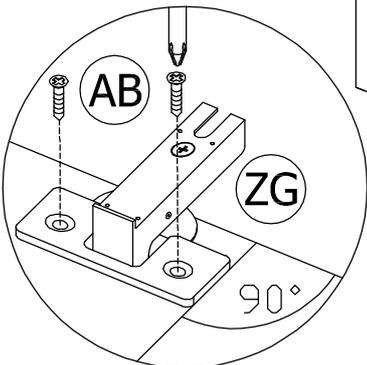
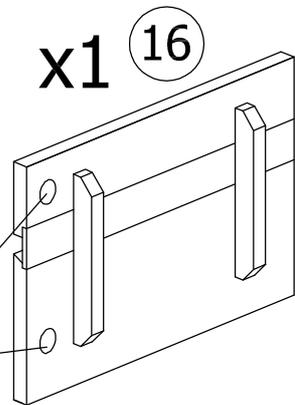
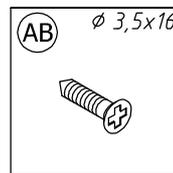
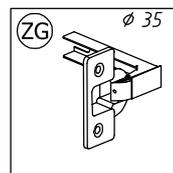
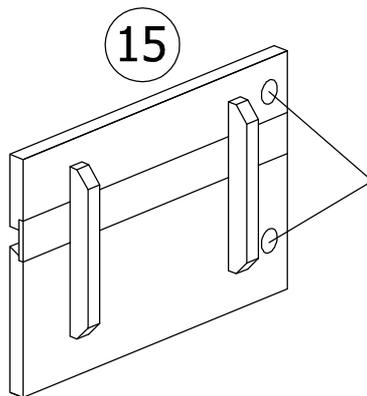

12

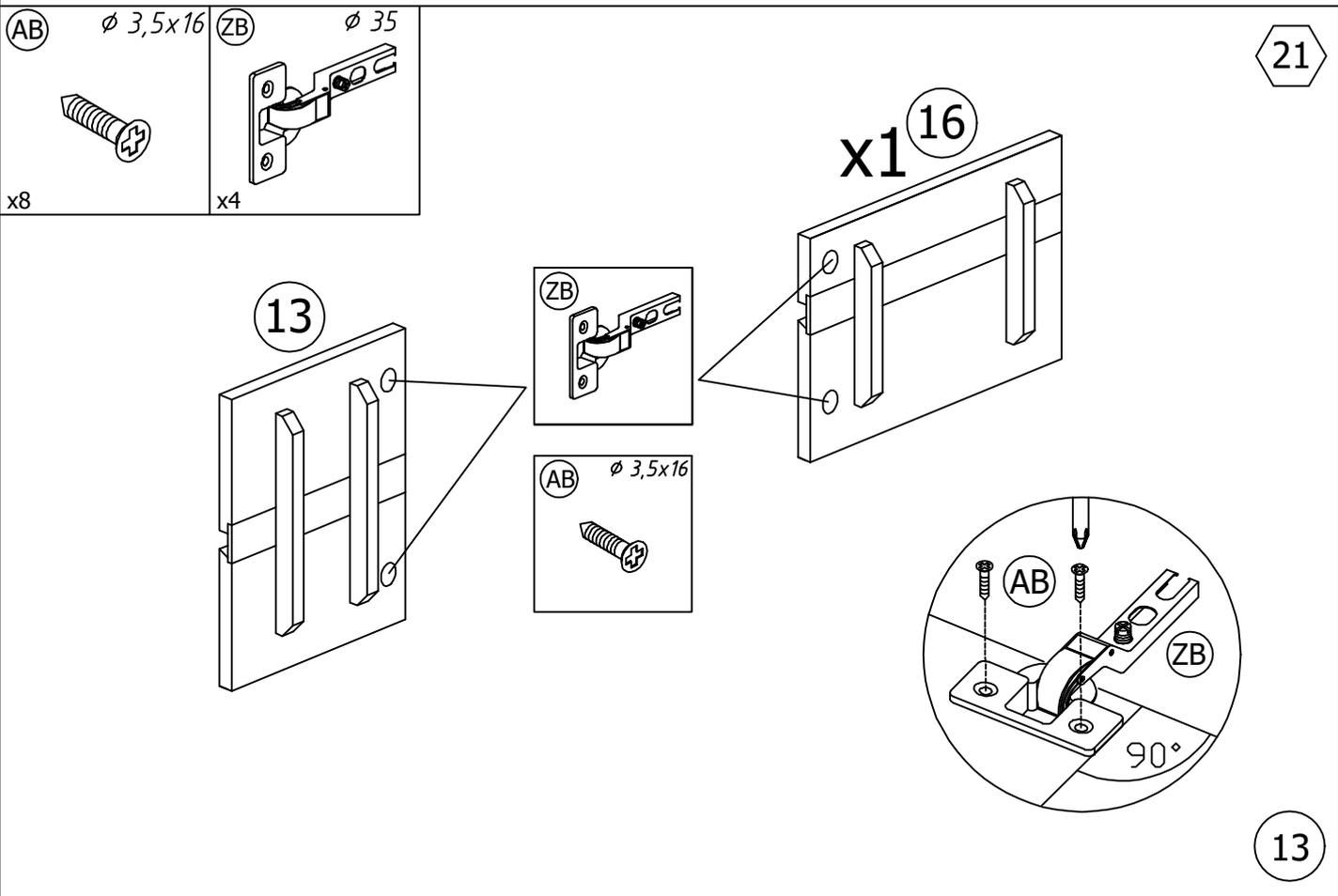
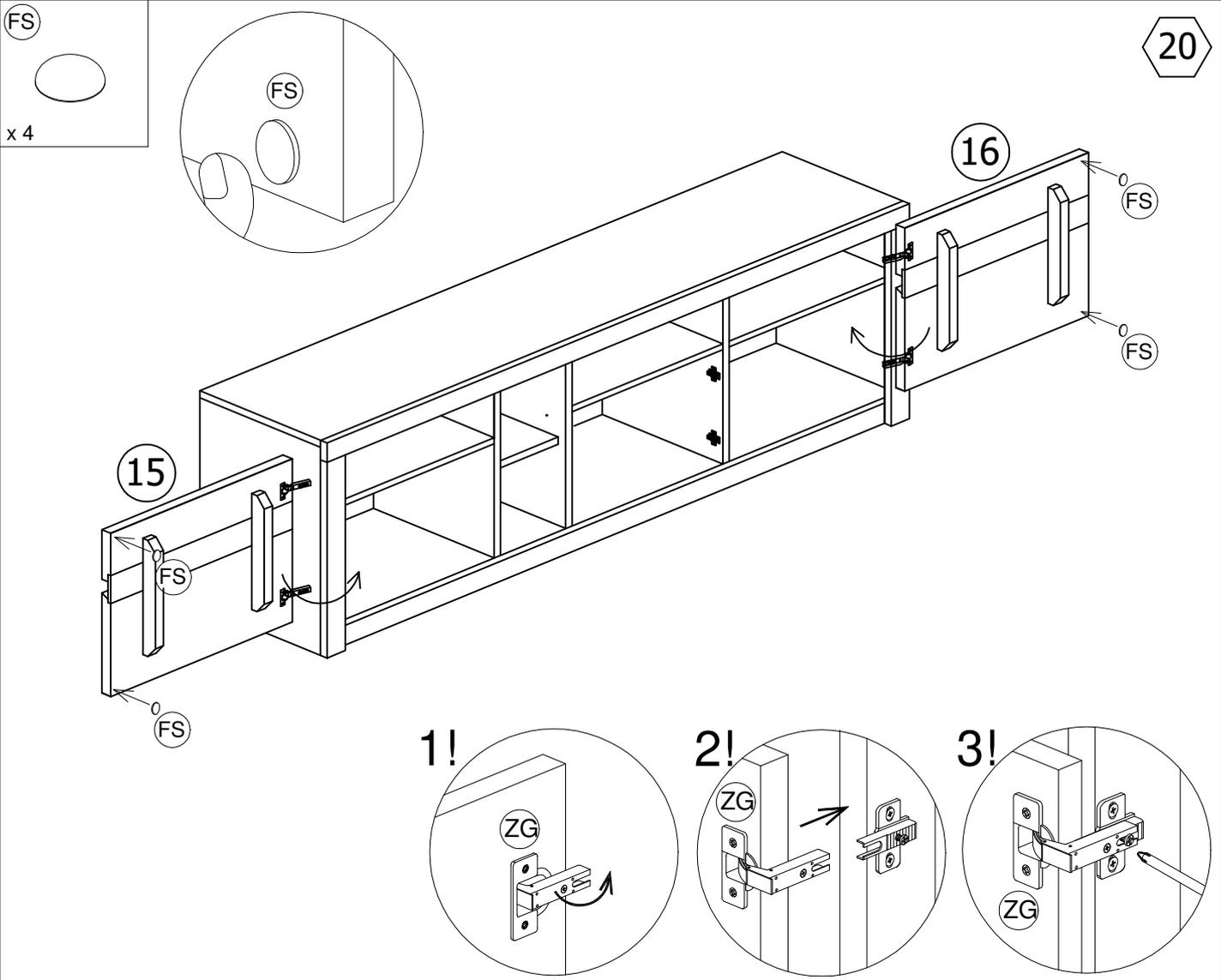

FS

x 4

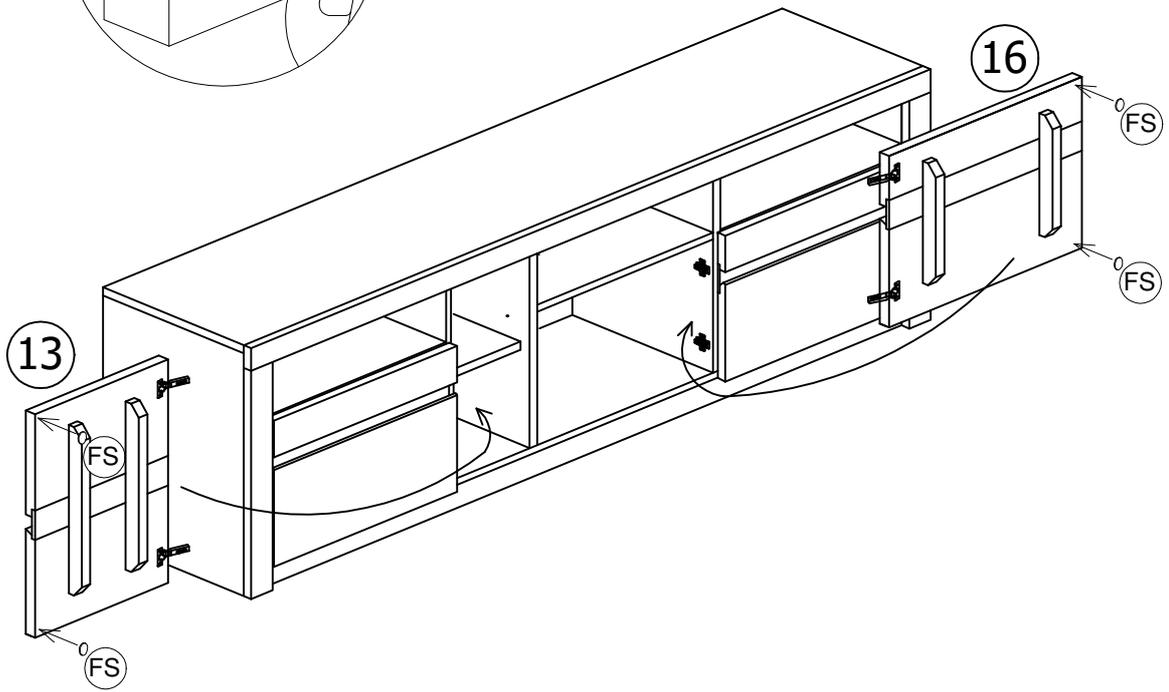

1!

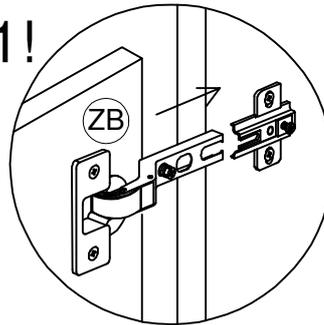

2!

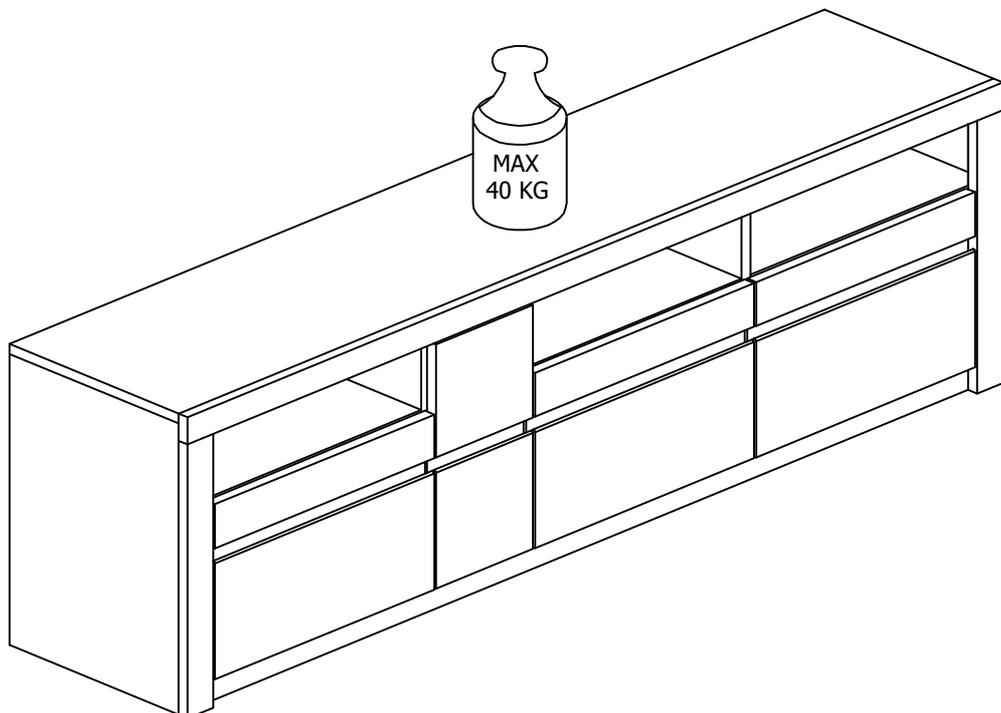
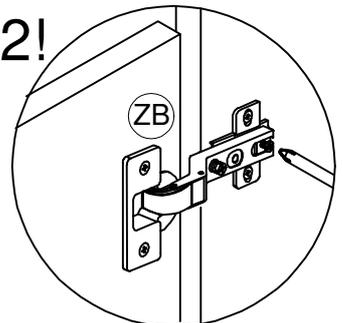

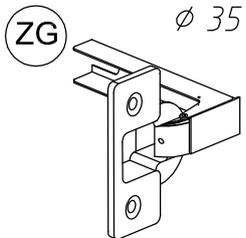

(D) Turen einstellen (Scharniere justieren)

(GB) Adjusting the doors (adjusting the hinges)

(F) Mettre la porte (égaliser les gonds)

(RO) Ajustați ușa (aliniați balamalele)

(I) Regolare la porta (livellare le parentesi)

(NL) Deuren instellen (scharnieren afstellen)

(PL) Nastawić drzwi (wyrównać zawiasy)

(TR) Kapıların ayarlanması (menteşelerin seviye ayarı)

(CZ) Seříd'te dveře (vyrovnajte závěsy)

(SK) Zrad'te dvere (vyrovnajte závesy)

(HU) Állítsa be az ajtó (igazítsa be a zsanérokot)

(RU) Регулировка дверей (регулировка шарнира)

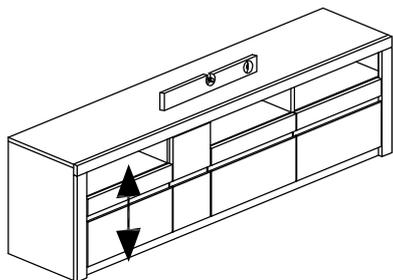

1!

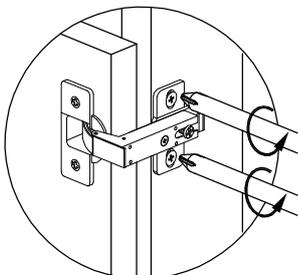

2!

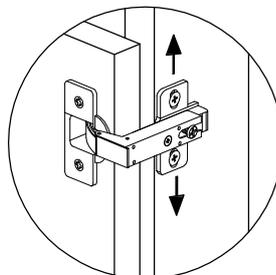

3!

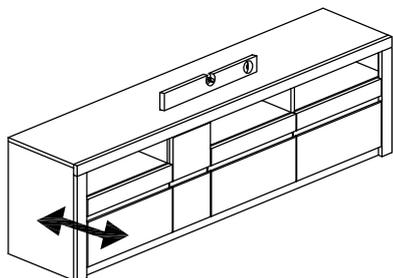
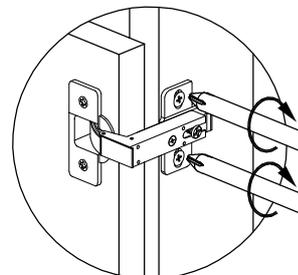

1!

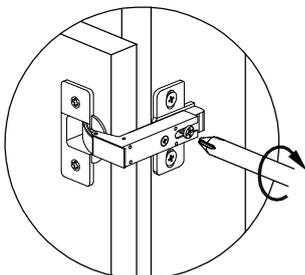

2!

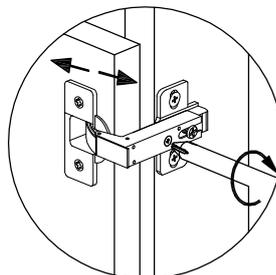

3!

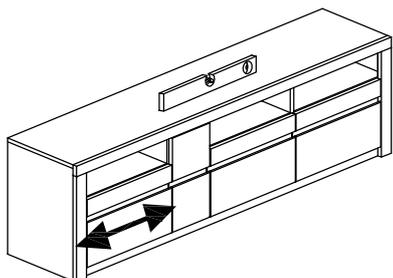
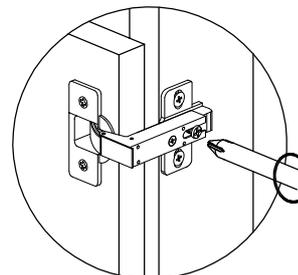

1!

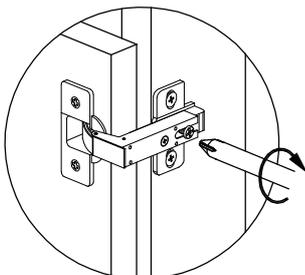

2!

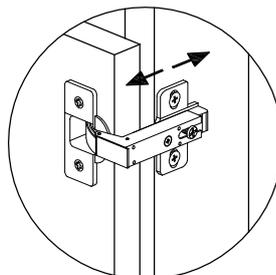

3!

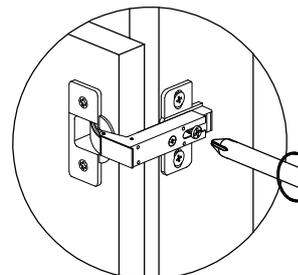

ZB

∅ 35

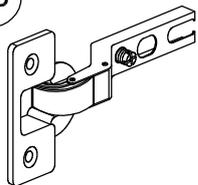

(D) Turen einstellen (Scharniere justieren)

(GB) Adjusting the doors (adjusting the hinges)

(F) Mettre la porte (égaliser les gonds)

(RO) Ajustați ușa (aliniați balamalele)

(I) Regolare la porta (livellare le parentesi)

(NL) Deuren instellen (scharnieren afstellen)

(PL) Nastawić drzwi (wyrównać zawiasy)

(TR) Kapıların ayarlanması (menteşelerin seviye ayarı)

(CZ) Seříd'te dveře (vyrovnajte závěsy)

(SK) Zrad'te dvere (vyrovnajte závesy)

(HU) Állítsa be az ajtó (igazítsa be a zsanérokot)

(RU) Регулировка дверей (регулировка шарнира)

1!

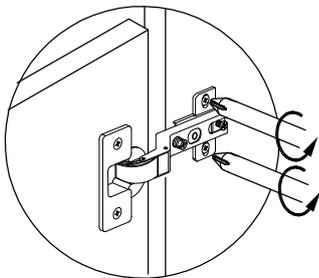
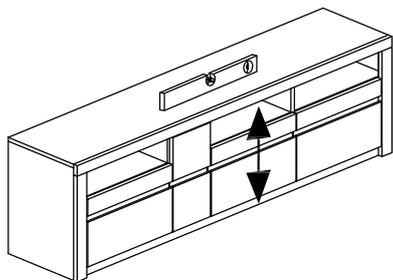

2!

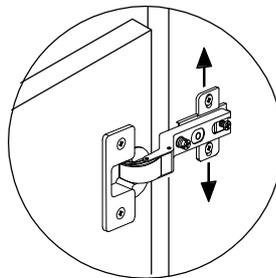

3!

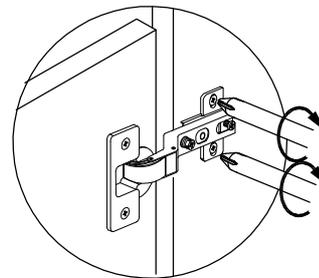

1!

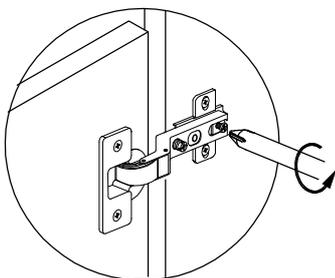
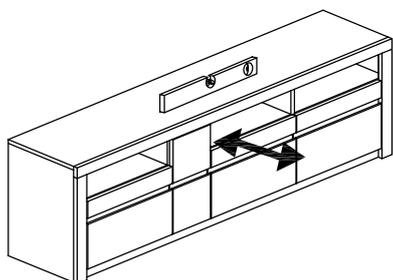

2!

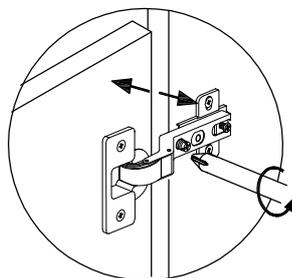

3!

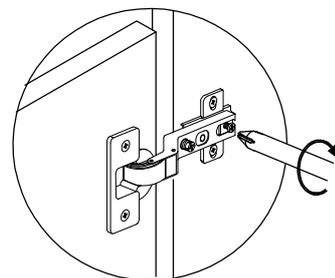

1!

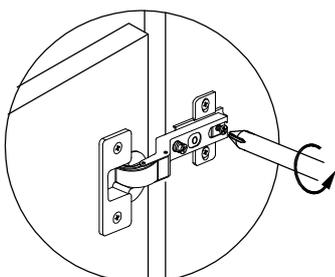
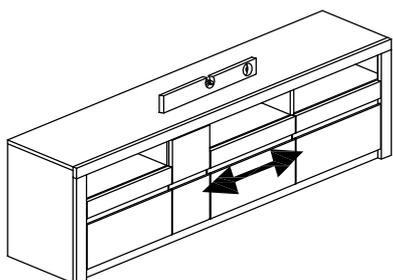

2!

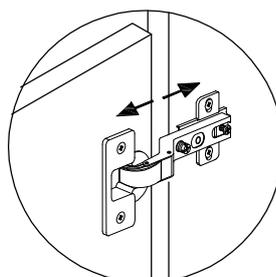

3!

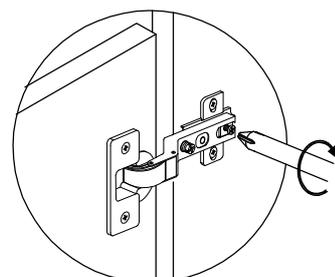

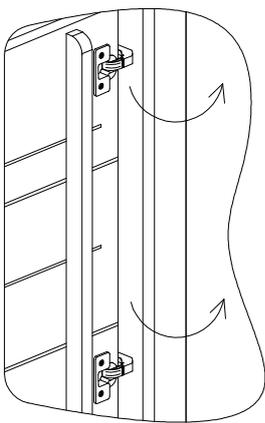
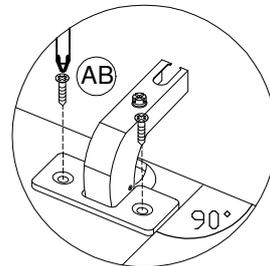
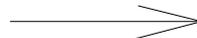
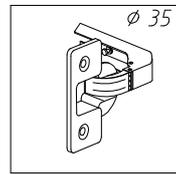
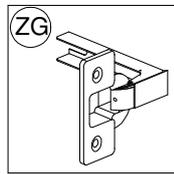
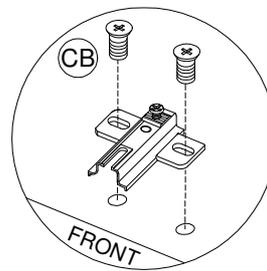
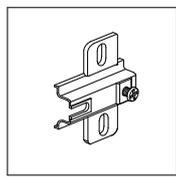
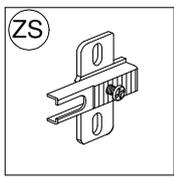

1!

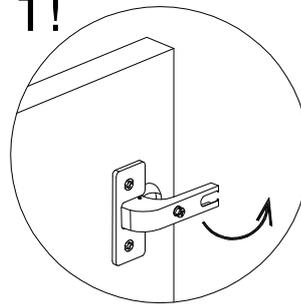

2!

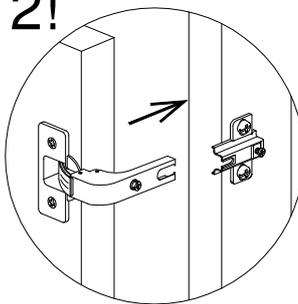

3!

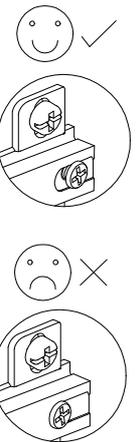
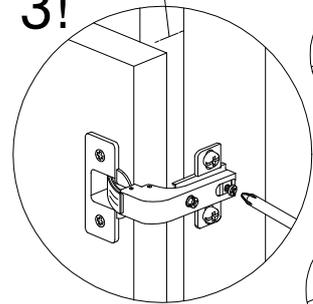

(D) Turen einstellen (Scharniere justieren)

(GB) Adjusting the doors (adjusting the hinges)

(F) Mettre la porte (égaliser les gonds)

(RO) Ajustați ușa (aliniați balamalele)

(PL) Nastawić drzwi (wyrównać zawiasy)

(TR) Kapıların ayarlanması (menteşelerin seviye ayarı)

(CZ) Seřídít dveře (vyrovnajte závěsy)

(SK) Zradít dveře (vyrovnajte závesy)

(I) Regolare la porta (livellare le parentesi)

(NL) Deuren instellen (scharnieren afstellen)

(HU) Állítsa be az ajtó (igazítsa be a zsanérokot)

(RU) Регулировка дверей (регулировка шарнира)

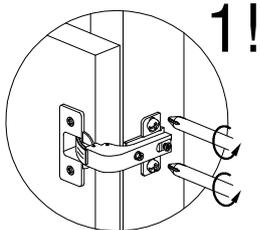

1!

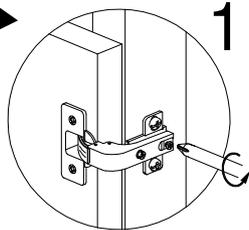

1!

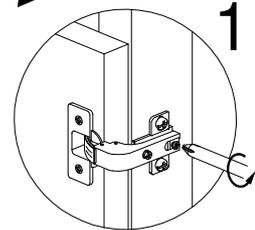

1!

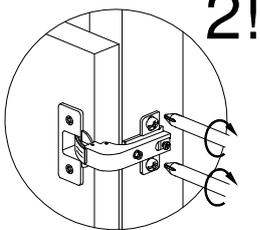

2!

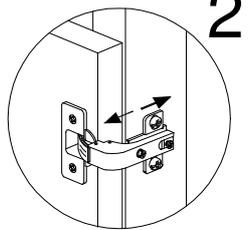

2!

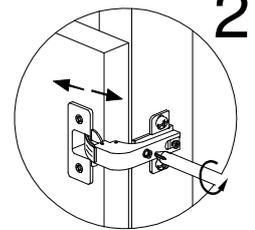

2!

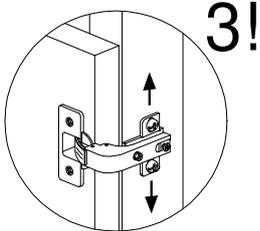

3!

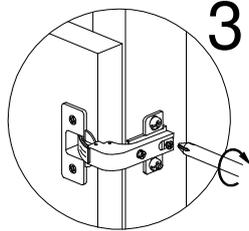

3!

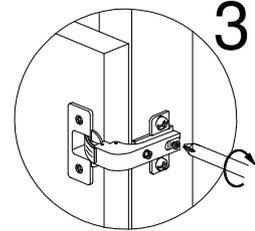

3!

(D) Montageanleitung

(I) Istruzioni di montaggio

(CZ) Montážní návod

LKZ 41194

(GB) Assembly instructions

(NL) Handleiding voor de montage

(SK) Návod na montáž

(F) Notice de montage

(PL) Instrukcja montażu

(HU) Szerelési útmutató

(RO) Instrucțiuni de montaj

(TR) Montaj talimatı

(RU) Инструкция по монтажу



SILKEBORG SI-83 R

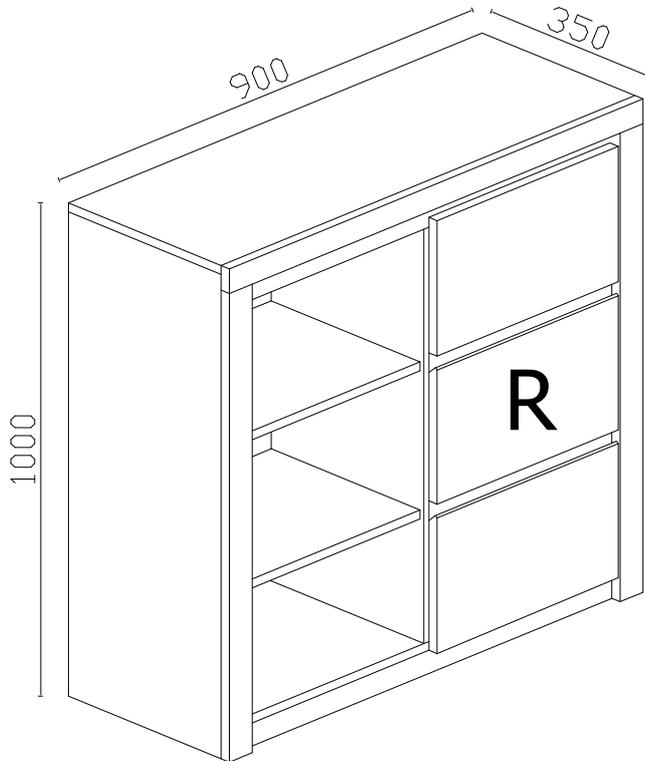

R ? L

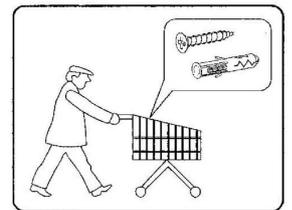
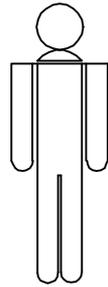

! Uwaga • Achtung • Attention • Caution • Figyele • Attenzione • Opgelet
Atentje • Upozornenie • Dikkat • Upozornění • Внимание **!**

(D) Bitte nur mit einem Staubtuch oder leicht feuchtem Lappen reinigen.
Keine scheuernden Putzmittel verwenden

(GB) Please only with a duster or a damp cloth.
Do not use any abrasive cleaners

(F) Le nettoyage se fait uniquement à l'aide d'un torchon ou d'une serviette
légèrement mouillée

(RO) Curățarea trebuie efectuată numai o cârpă sau cu un prosop ușor umezit
Nu utilizați agenți de curățare abrazivi

(I) Pulire esclusivamente con un panno o un asciugamano umido

(NL) Reinig alleen met een stofdoek of een lichtjes vochtige doek
Gebruik geen schurende poetsmiddelen

(PL) Czyszczenie należy wykonać wyłącznie za pomocą ściereczki lub lekko nawilżonego
ręcznika. Nie stosować środków czyszczących do szorowania

(TR) Lütfen sadece bir toz beziyile veya hafif nemli yumuşak bir bezle siliniz.
Aşındırıcı temizlik malzemeleri kullanmayınız

(CZ) Čistění je nutné vykonávat výhradně pomocí utěrky nebo lehce navlhčeného ručníku.
Nepoužívejte čističí prostředky obsahující abrazivní částice

(SK) Čistení je nutné vykonávať výhradne pomocí utierky alebo ľahko zvlhnutým ručníkom
Nepoužívajte čistiaci prostriedky obsahujúci abrazívni častice

(HU) A tisztítás kizárólag törleruha vagy enyhén nedvesített törülköző segítségével végezhető.
Súroló hatású tisztítószereket nem szabad használni

(RU) Очищайте от пыли тряпкой или слегка влажной ветошью. Не допускается применение
чистящих средств, не пред-назначенных для ухода за мебелью.

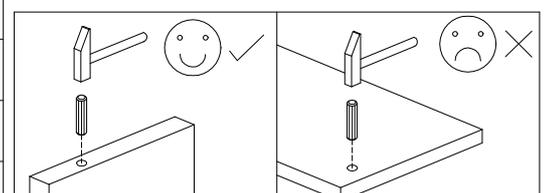
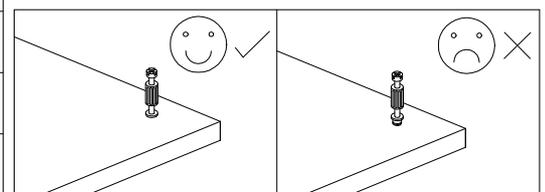
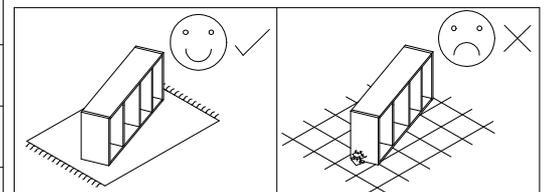
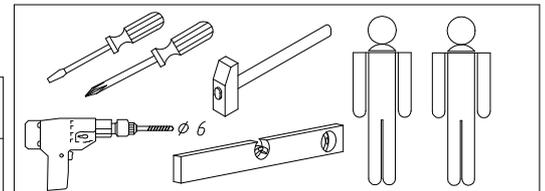

(D) Servicekarte

(RO) Carte de service

(PL) Karta serwisowa

(SK) Služobný preukaz

(GB) Service card

(I) Carta di servizio

(TR) Servis karti

(HU) Szerviz kártya

(F) Carte de service

(NL) Dienst kaart

(CZ) Servisni karta

(RU) Сервисная карта

SILKEBORG SI-83 R

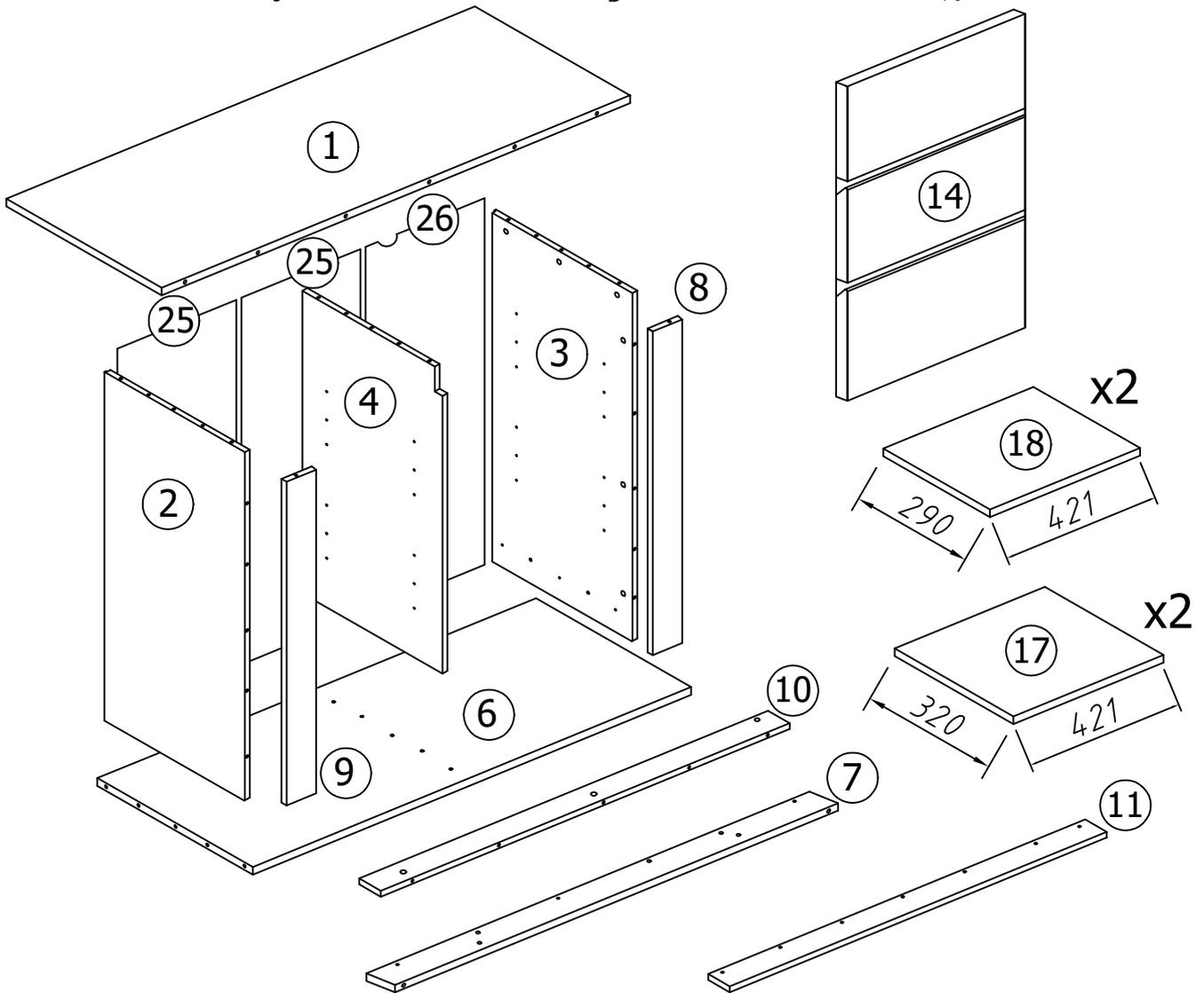
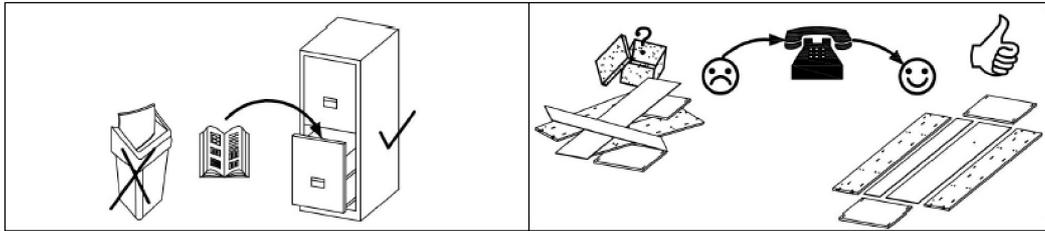

| | | | | | | | | | |
|----------|----------------------------|----------------------------|------------------------------|----------------------------|----------------------------|----------------------------|----------|------------------|------------------------------|
| (A) x30 | (B) x30 | (C) x19 | (D) $\phi 8 \times 30$ x20 | (E) x16 | (J) x2 | (K) x1 | (N) x3 | (R) $\phi 1$ x40 | (AB) $\phi 3,5 \times 16$ x4 |
| (AV) x1 | (BO) $\phi 4 \times 25$ x5 | (BW) $\phi 6 \times 30$ x1 | (CB) $\phi 6,3 \times 13$ x4 | (CP) $\phi 4 \times 16$ x1 | (D2) $\phi 8 \times 20$ x2 | (DB) $\phi 4 \times 40$ x1 | (FG) x4 | (FS) x2 | (ZG) $\phi 35$ x2 |
| (ZS) x2 | | | | | | | | | |

B

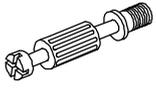

x6

D

∅8x30

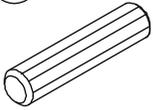

x12

1

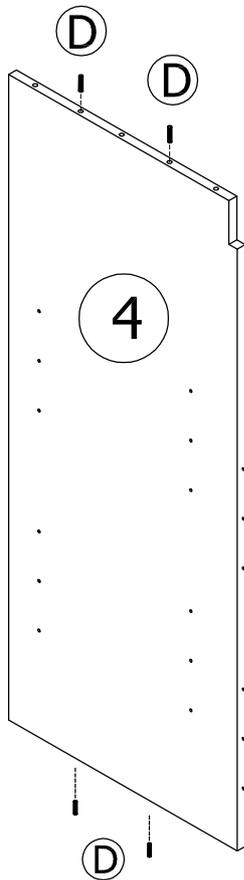
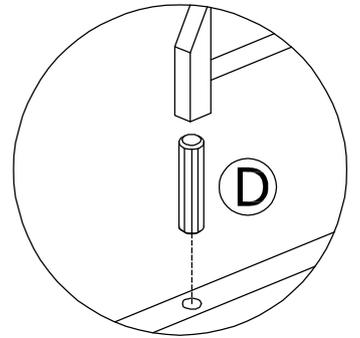
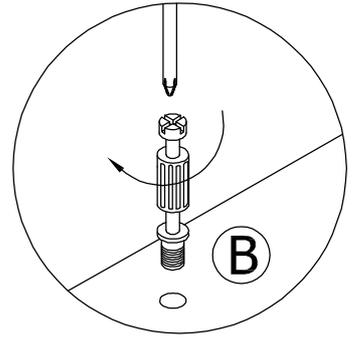
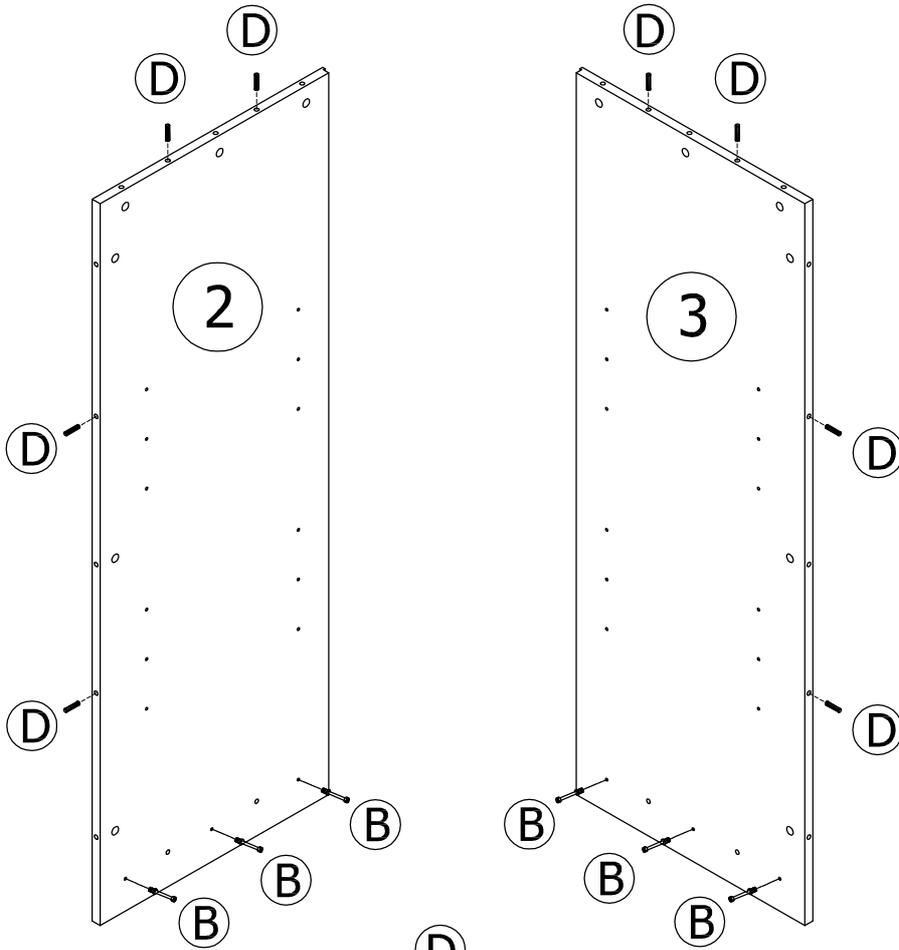

3

B

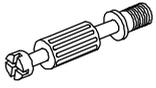

x12

D

∅8x30

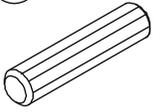

x8

2

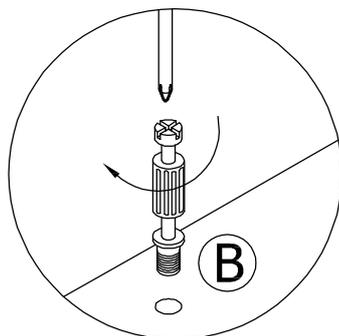
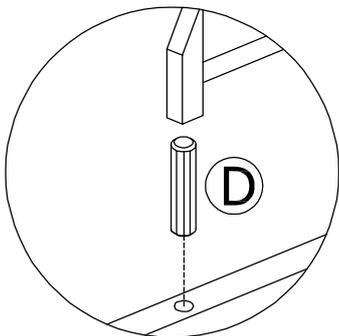
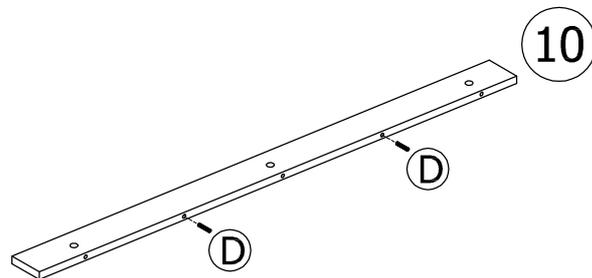
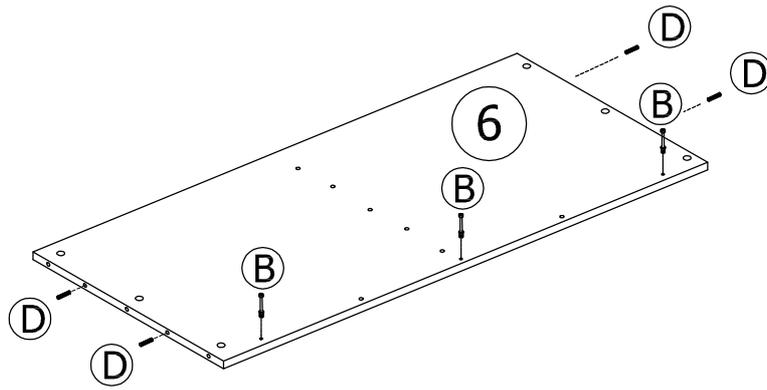
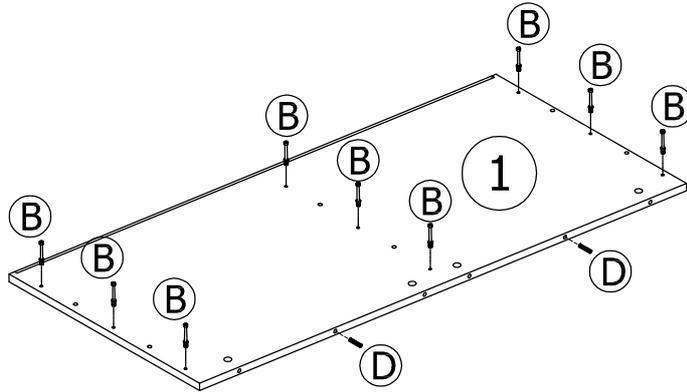

4

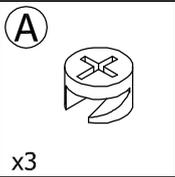

3

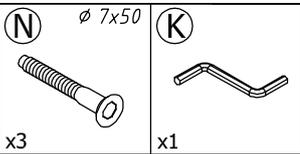
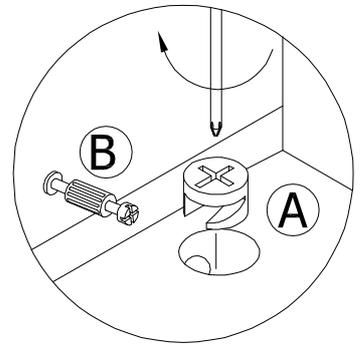
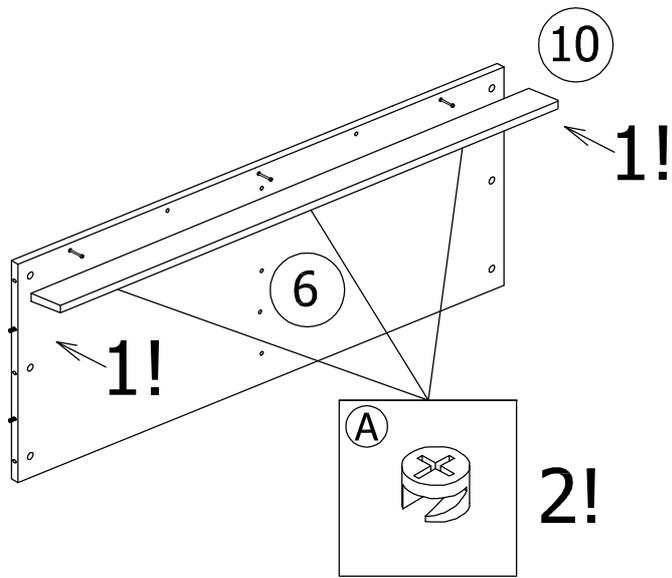

4

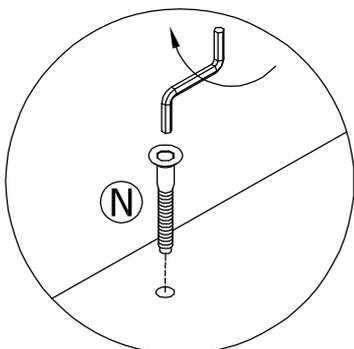
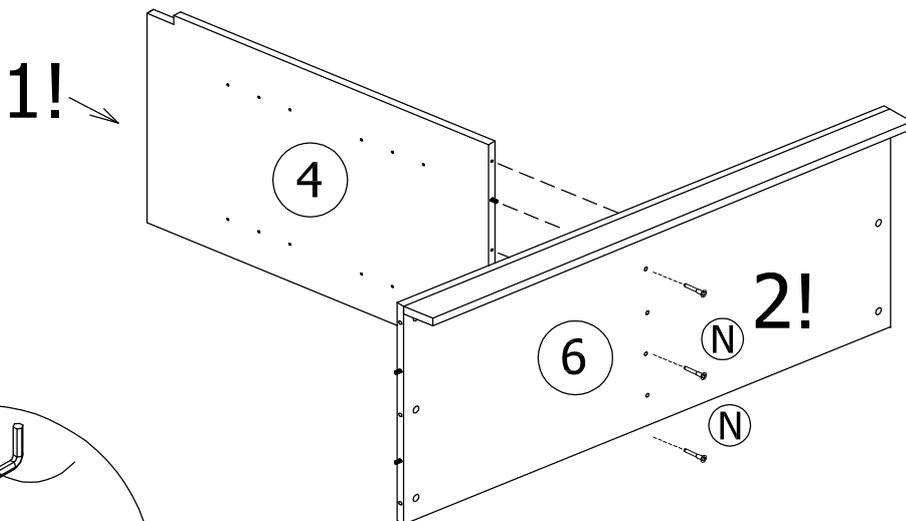

5

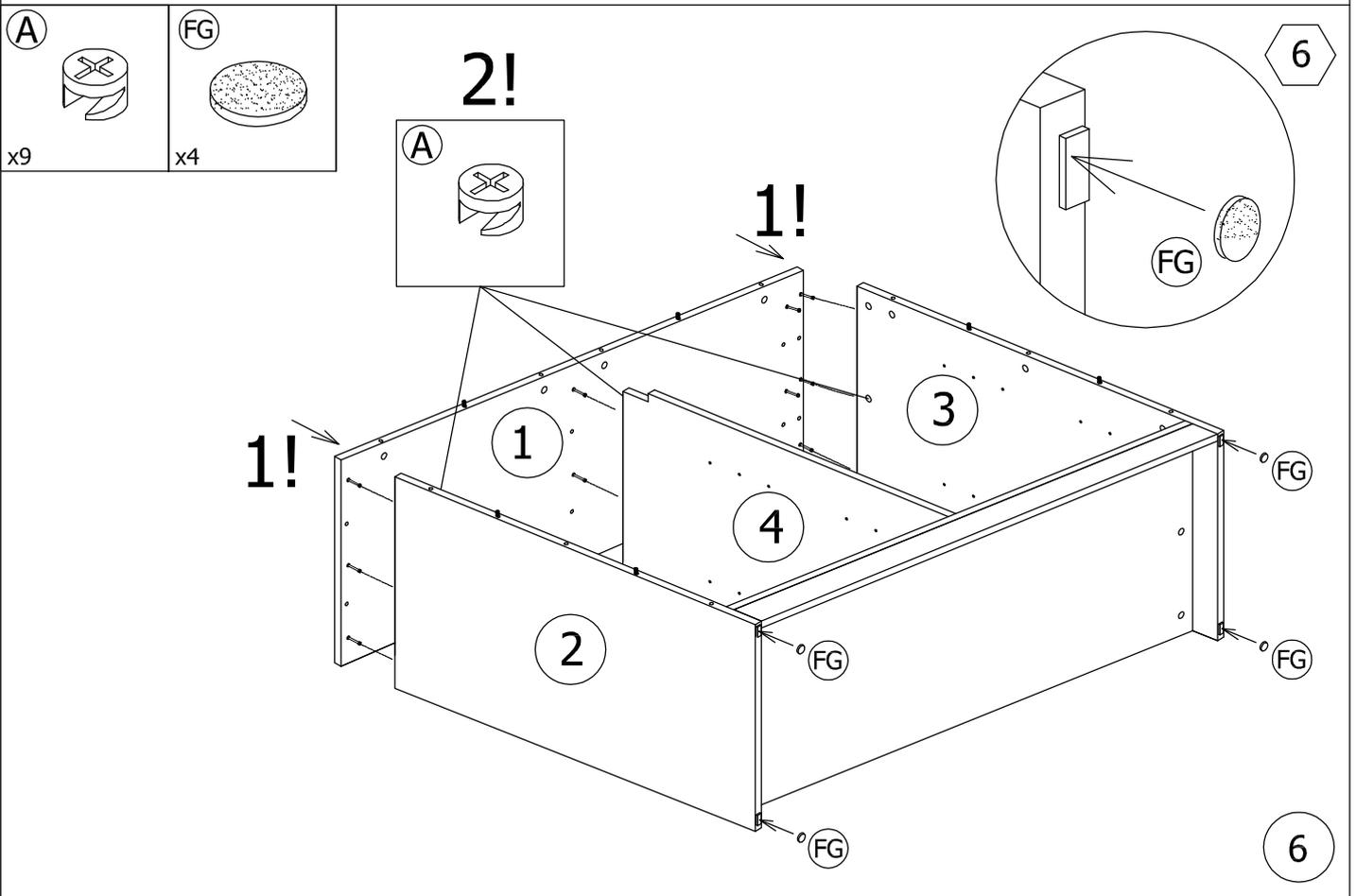
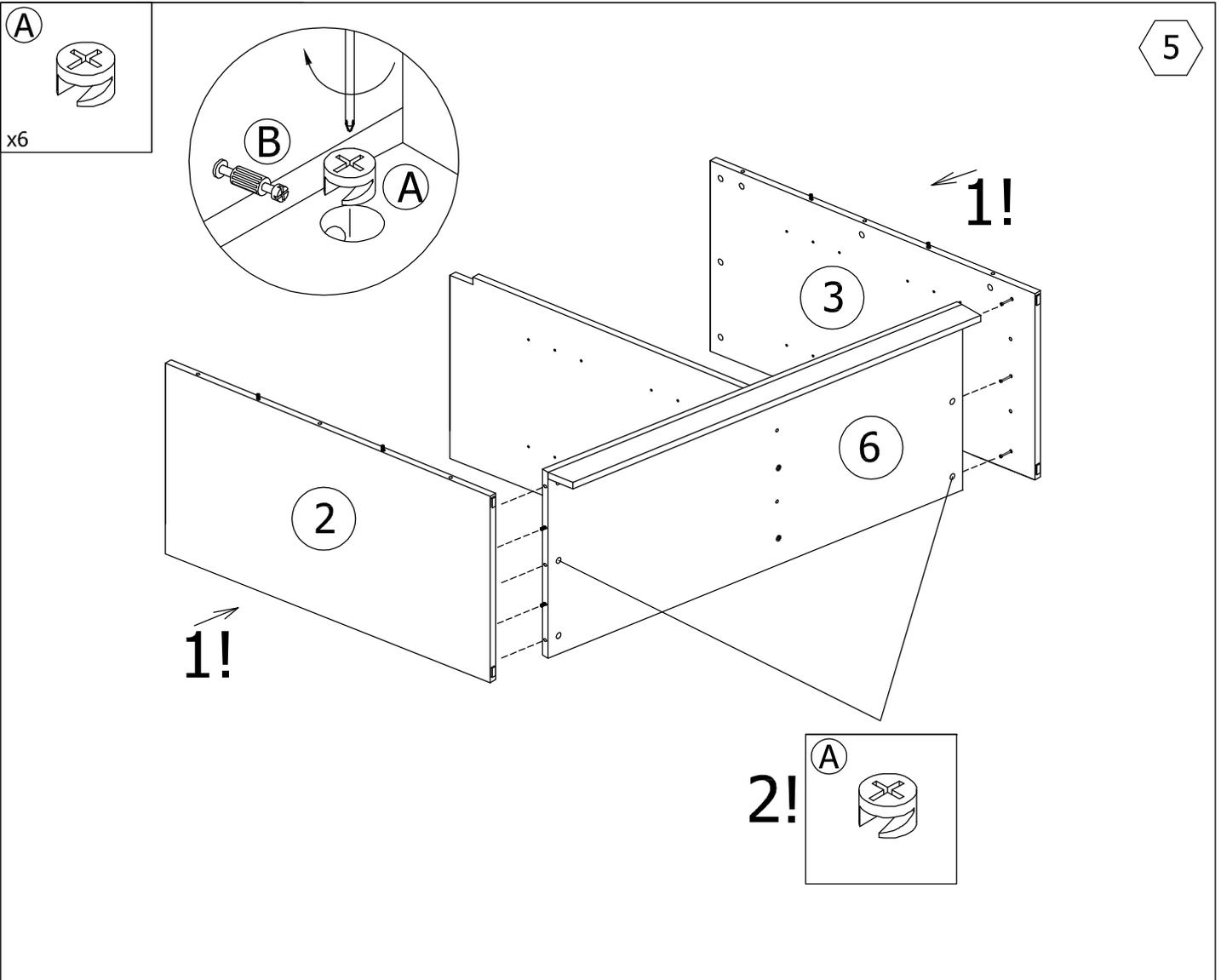

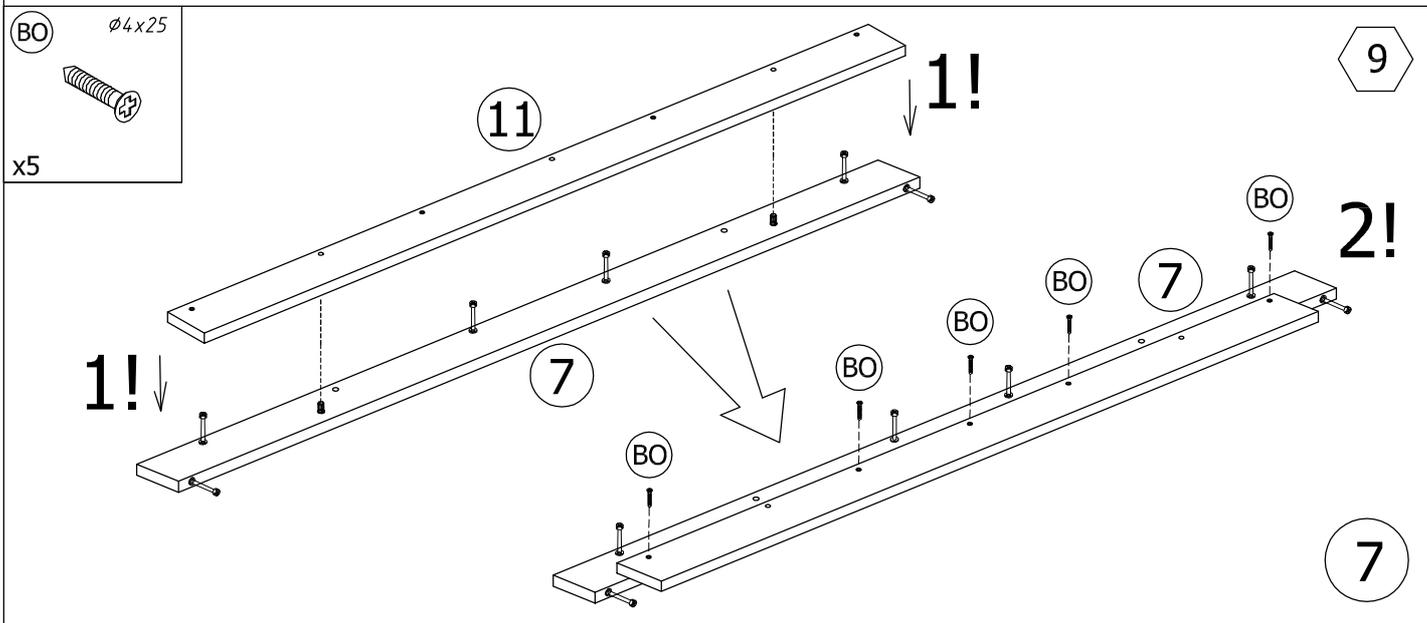
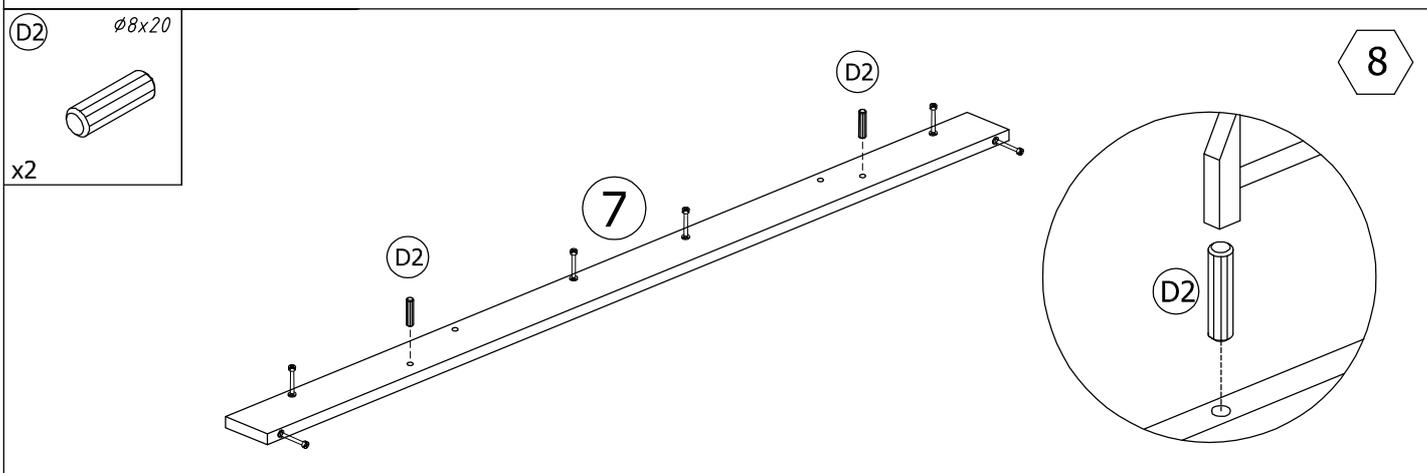
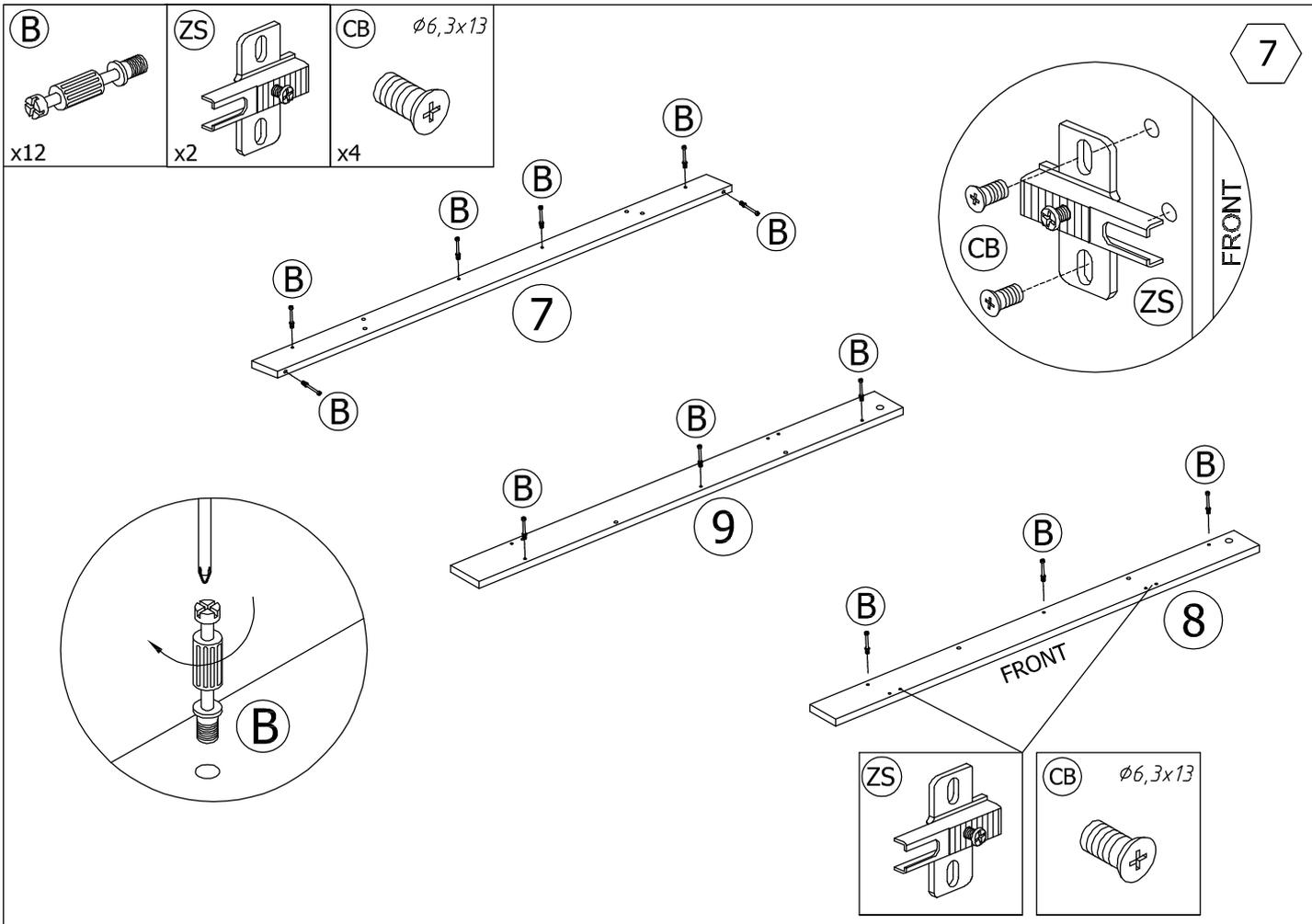

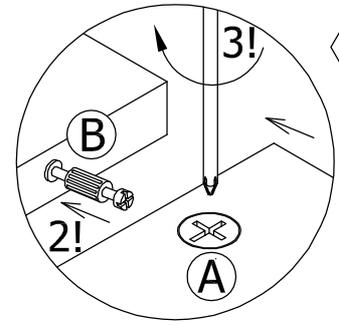
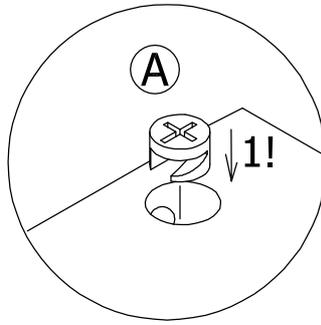
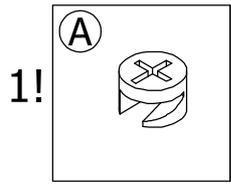
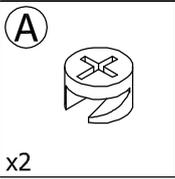

10

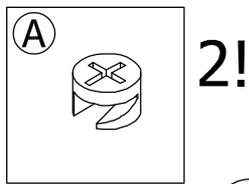
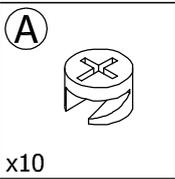
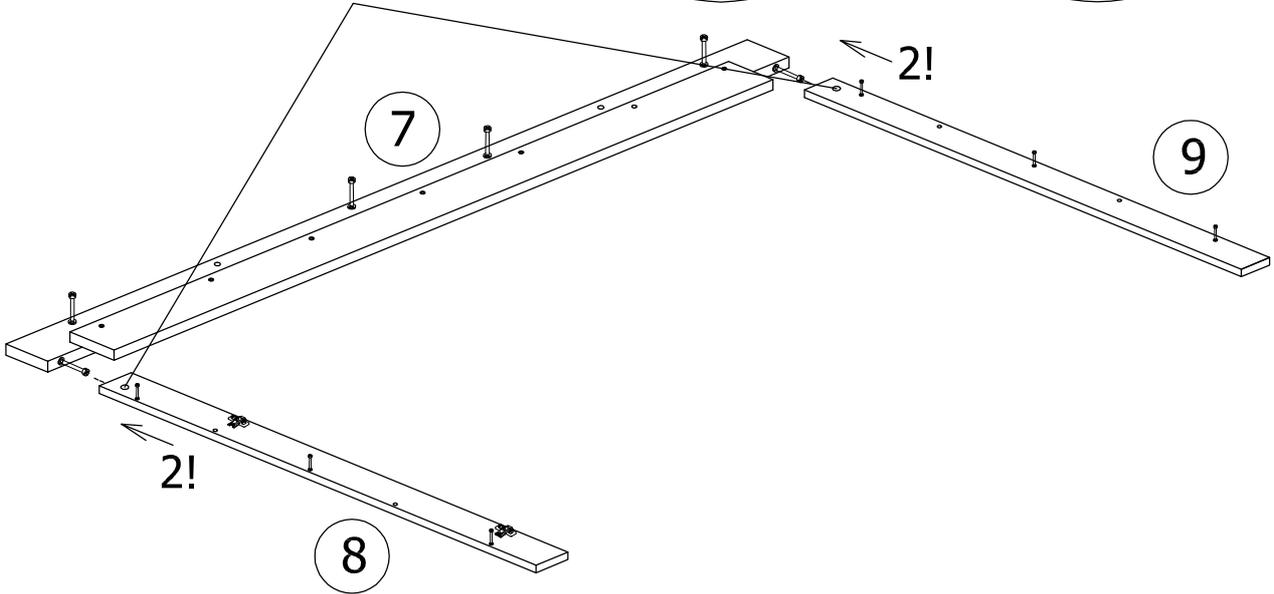

11

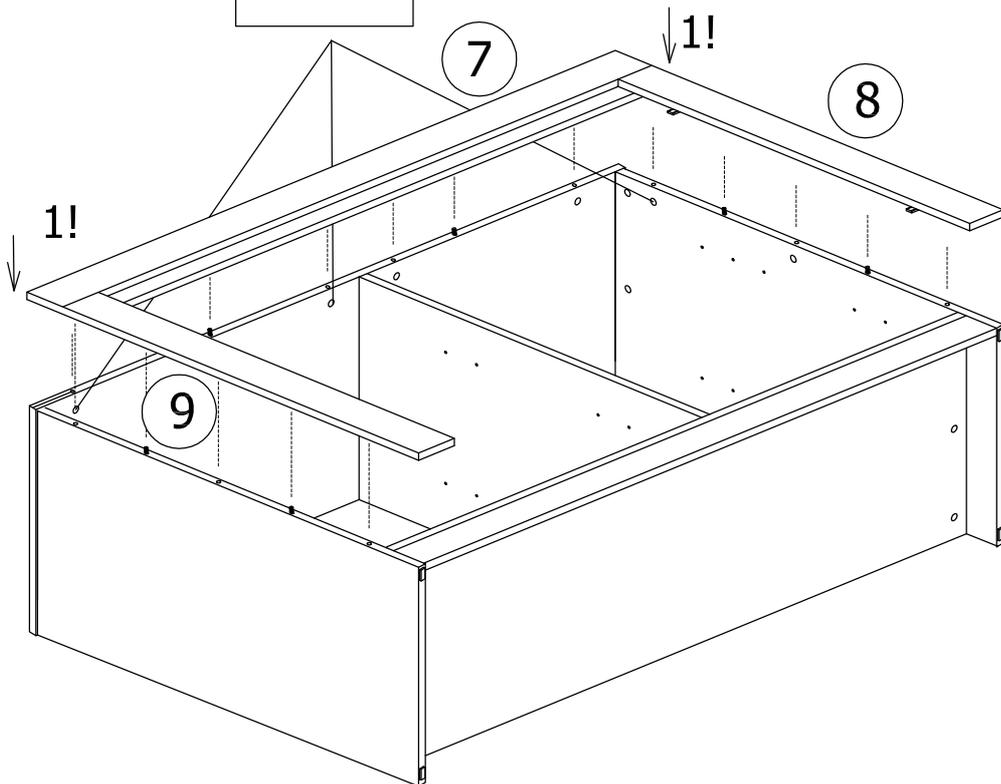

8

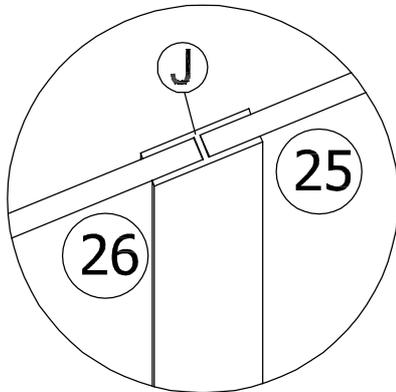
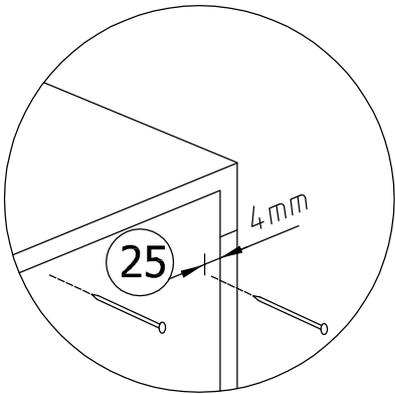
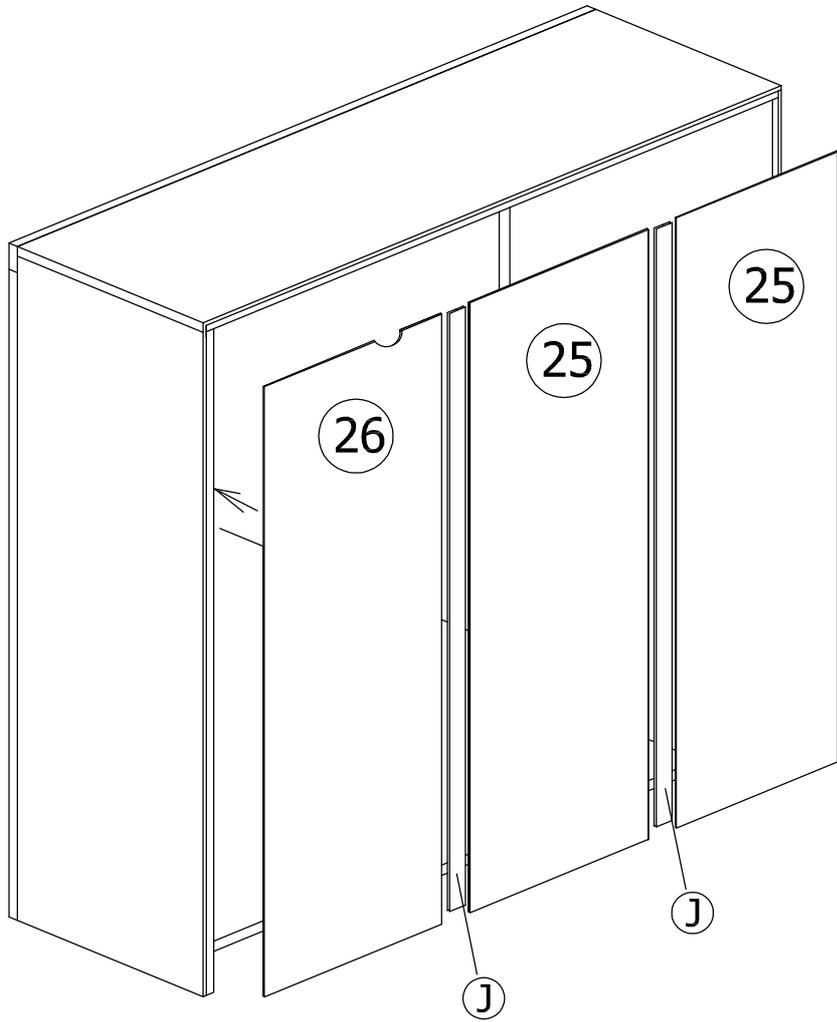
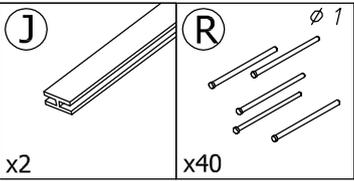

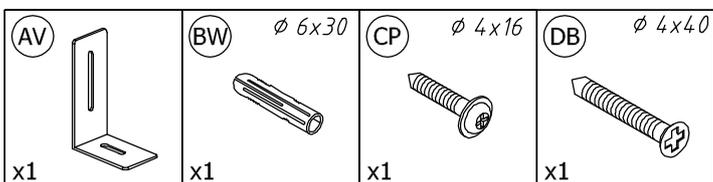

13

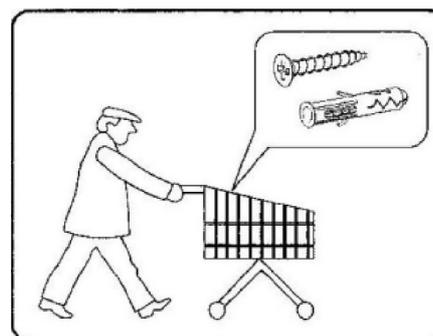
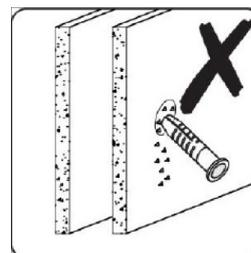
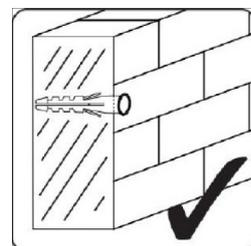
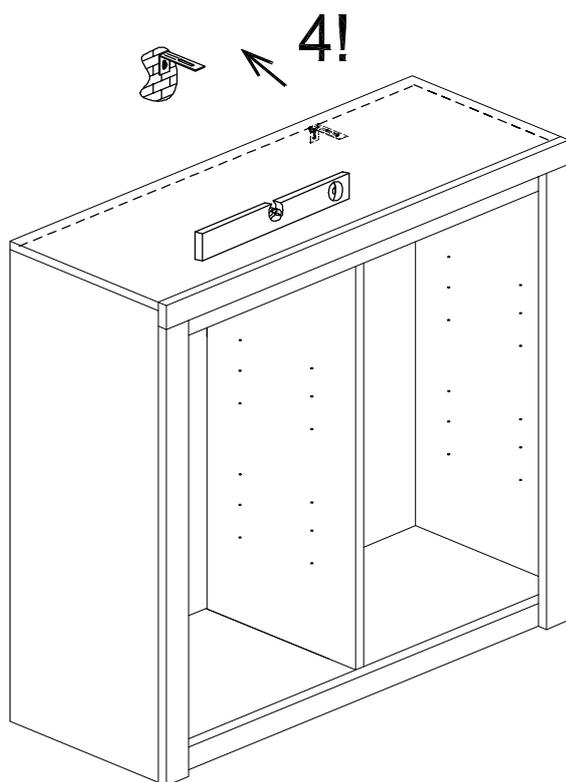
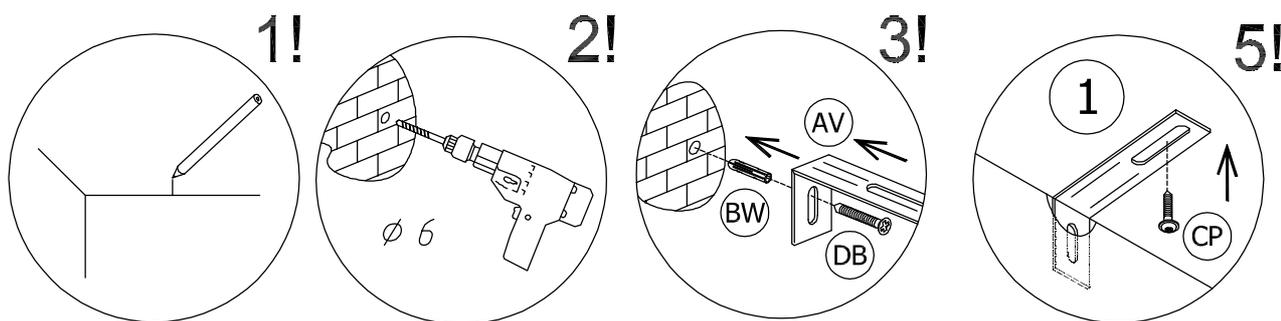

| Uwaga • Achtung • Attention • Caution • Figyele • Attenzione • Opgelet , Atentie • Upozornenie • Dikkat • Upozornini • Внимание | |
|--|--|
| D | Die Befestigung des Möbelsstückes an der Wand muss von einer fachkundigen Person vorgenommen werden, da für die Montage an die Wand angepasste Dübel erforderlich sind |
| GB | A qualified professional is required when mounting furniture to the wall since dowels corresponding to the wall are required for this |
| F | Le montage du meuble au mur peut être fait uniquement par le personnel spécialisé. Il est nécessaire d'utiliser des chevilles bien ajustées pendant le montage au mur. |
| RO | Montarea mobilei pe poate fi efectuată numai de către personalul calificat deoarece la această montare se folosește cepuri. |
| I | Attaccare un alla parete può essere effettuato esclusivamente dal personale adatto perché durante il montaggio bisogna usare dei cavicchi adatti. |
| NL | een vakkundige persoon dient het meubelstuk aan de muur te bevestigen; voor de montage aan de muur zijn immers aangepaste pluugen vereist |
| PL | Mocowanie do ściany może przeprowadzić wyłącznie odpowiedni do tego personel, ponieważ w czasie montażu w ścianie konieczne jest zastosowanie dopasowanych kółków |
| TR | Möbilya parçasının duvara sabitlenmesi, duvar montajı için özel uyarlanmış dübeller gerektirdiğinden bu iş sadece bu konuda uzman bir kişi tarafından gerçekleştirilmelidir. |
| CZ | Připevnění nábytku ke stěně může uskutečnit výhradně k tomu určený personál, protože pro montáž je nutné použít hmoždinky shodné s typem a tloušťkou stěny. |
| SK | Pripnenie nábytku k stene môže uskutočniť výhradne k tomu určený personál, pretože k montáži je nutné použiť hmoždinky zhodné s typom steny a jej hrúbkou |
| HU | A bútor a falhoz való rögzítését kizárólag erre illetékes személyzet végezheti, mivel a falhoz való rögzítés során megfelelő méretű csapszeg alkalmazása szükséges. |
| RU | Очищайте от пыли тряпкой или слегка влажной ветошью. Не допускается применение чистящих средств, не предназначенных для ухода за мебелью. |

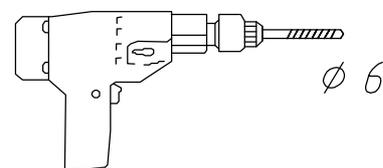
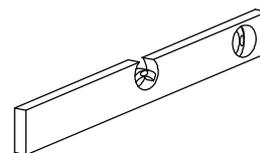

10

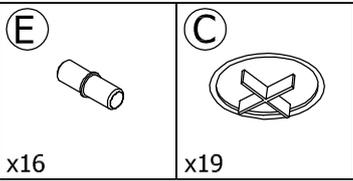

14

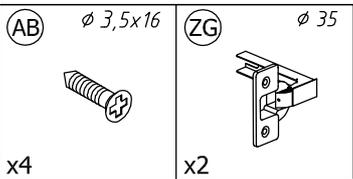
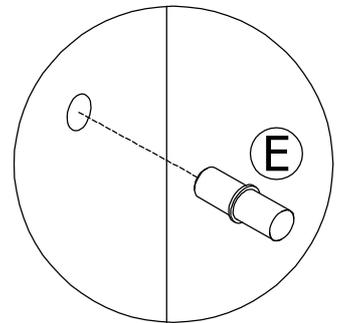
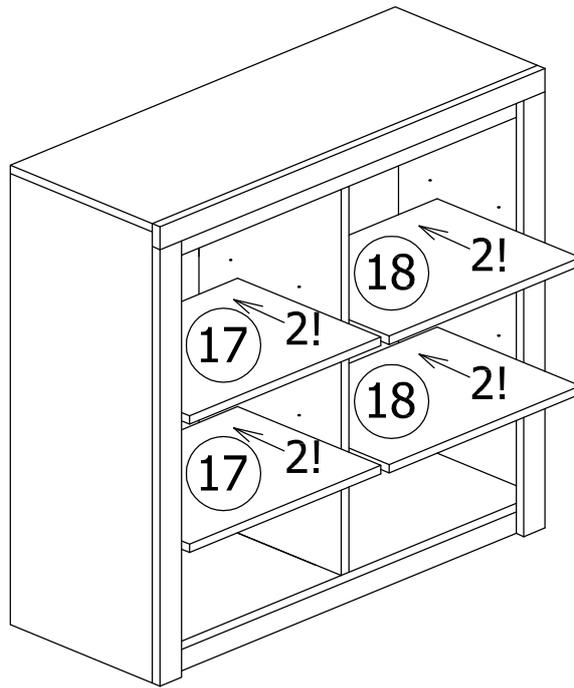
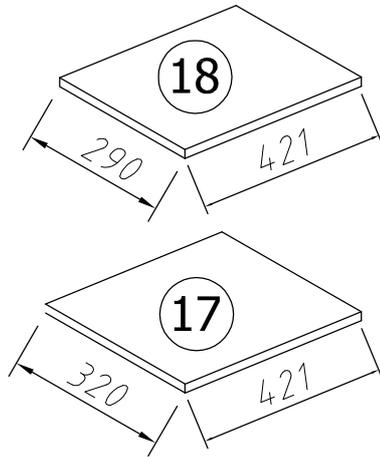
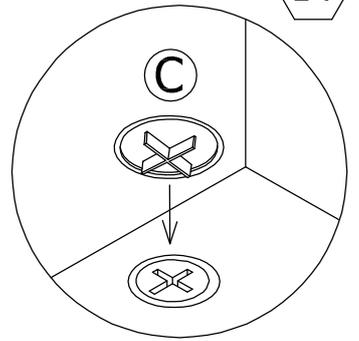

15

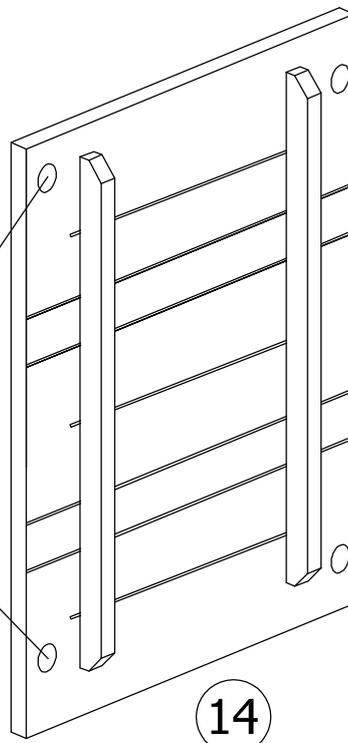
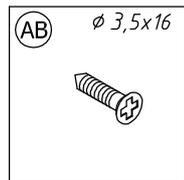
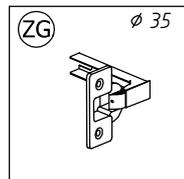
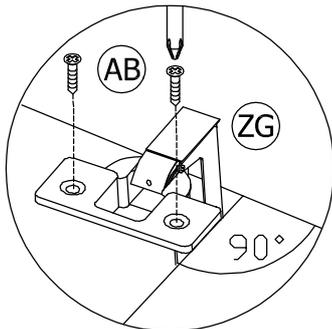

14

11

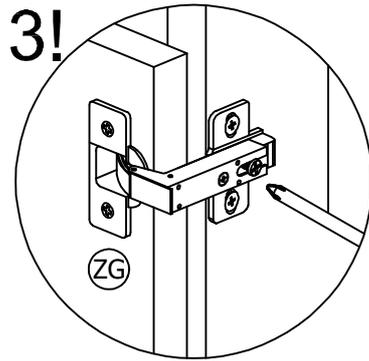
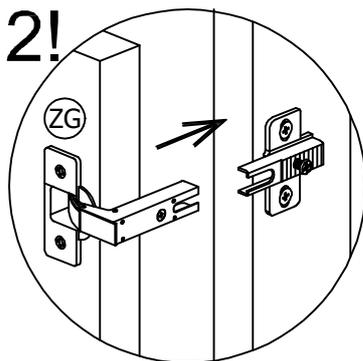
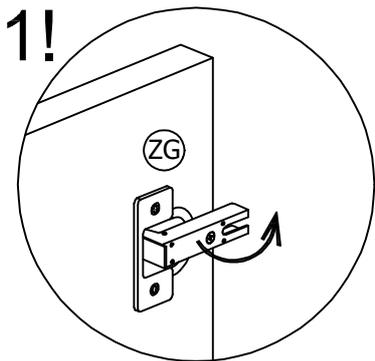
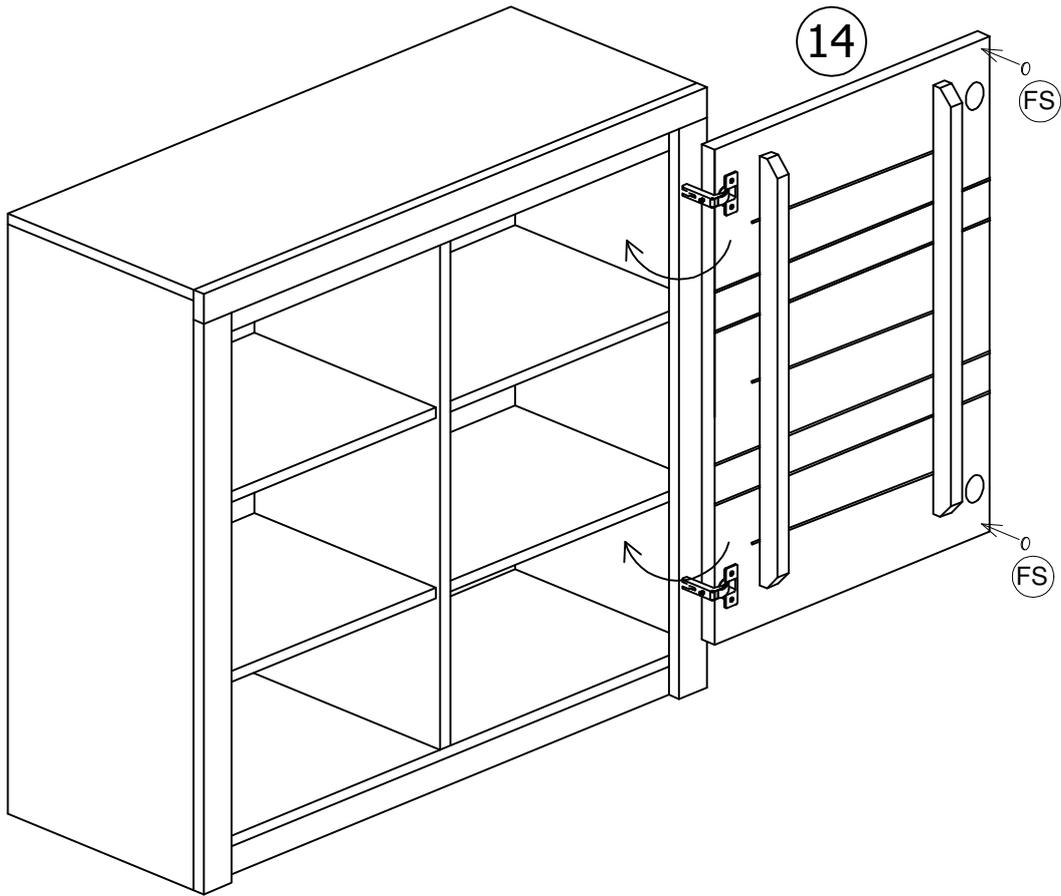
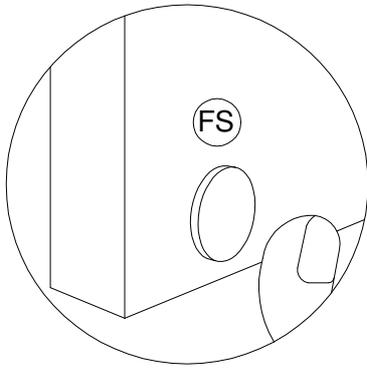
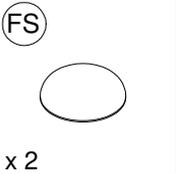

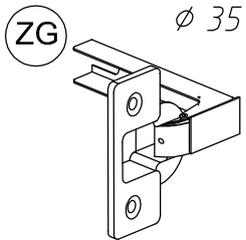

(D) Turen einstellen (Scharniere justieren)

(GB) Adjusting the doors (adjusting the hinges)

(F) Mettre la porte (égaliser les gonds)

(RO) Ajustați ușa (aliniați balamalele)

(I) Regolare la porta (livellare le parentesi)

(NL) Deuren instellen (scharnieren afstellen)

(PL) Nastawić drzwi (wyrównać zawiasy)

(TR) Kapıların ayarlanması (menteşelerin seviye ayarı)

(CZ) Seříd'te dveře (vyrovnajte závěsy)

(SK) Zrad'te dvere (vyrovnajte závesy)

(HU) Állítsa be az ajtó (igazítsa be a zsanérokot)

(RU) Регулировка дверей (регулировка шарнира)

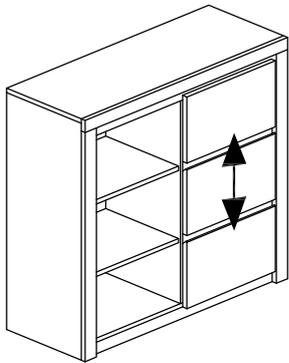

1!

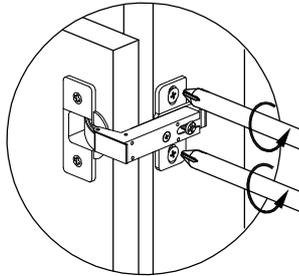

2!

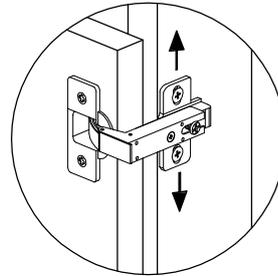

3!

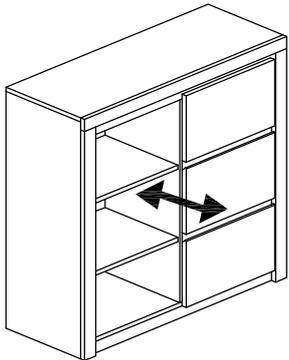
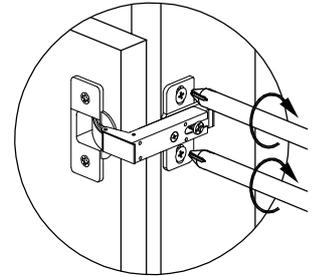

1!

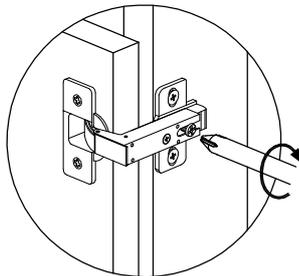

2!

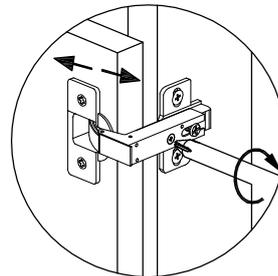

3!

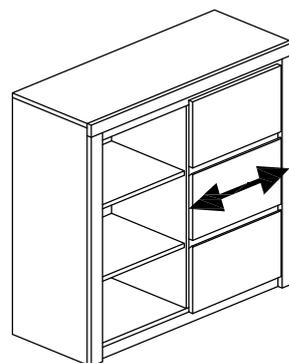
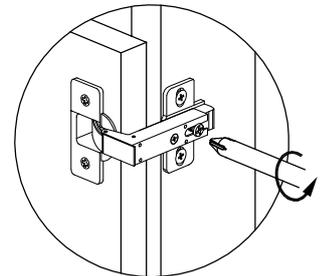

1!

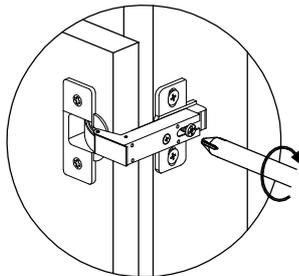

2!

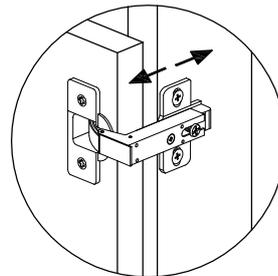

3!

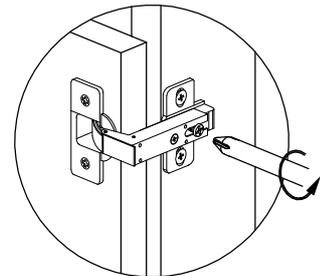

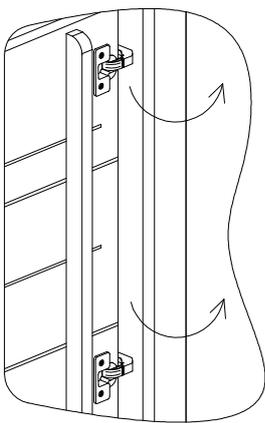
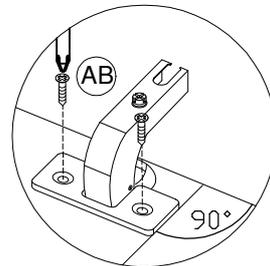
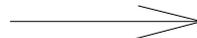
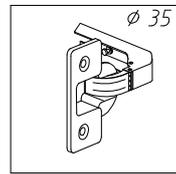
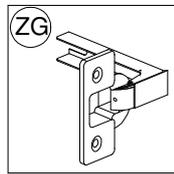
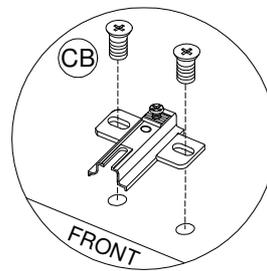
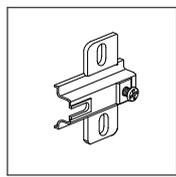
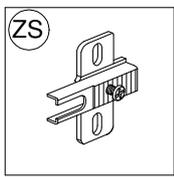

1!

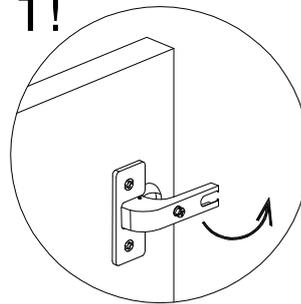

2!

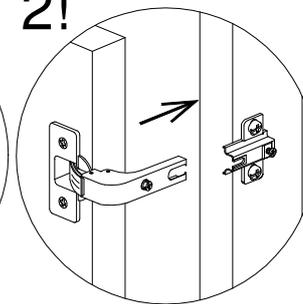

3!

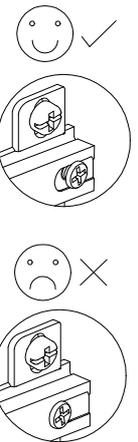
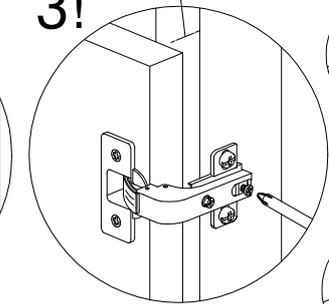

(D) Turen einstellen (Scharniere justieren)

(GB) Adjusting the doors (adjusting the hinges)

(F) Mettre la porte (égaliser les gonds)

(RO) Ajustați ușa (aliniați balamalele)

(PL) Nastawić drzwi (wyrównać zawiasy)

(TR) Kapıların ayarlanması (menteşelerin seviye ayarı)

(CZ) Seřídít dveře (vyrovnajte závěsy)

(SK) Zradít dveře (vyrovnajte závesy)

(I) Regolare la porta (livellare le parentesi)

(NL) Deuren instellen (scharnieren afstellen)

(HU) Állítsa be az ajtó (igazítsa be a zsanérokot)

(RU) Регулировка дверей (регулировка шарнира)

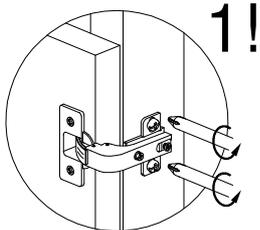

1!

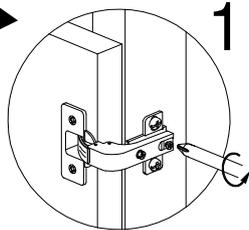

1!

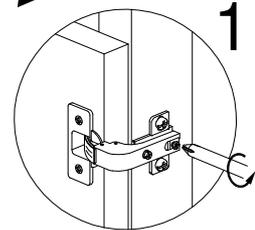

1!

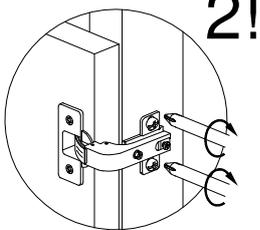

2!

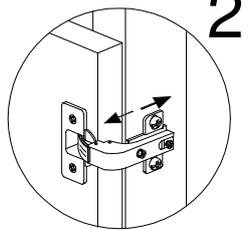

2!

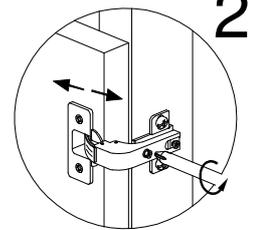

2!

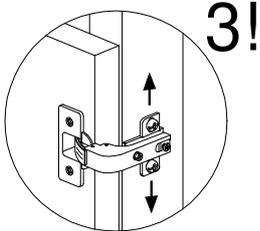

3!

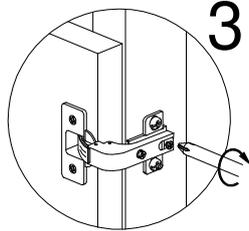

3!

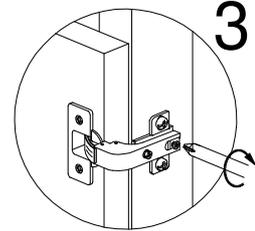

3!

(D) Montageanleitung

(I) Istruzioni di montaggio

(CZ) Montážní návod

LKZ 41194

(GB) Assembly instructions

(NL) Handleiding voor de montage

(SK) Návod na montáž

(F) Notice de montage

(PL) Instrukcja montażu

(HU) Szerelési útmutató

(RO) Instrucțiuni de montaj

(TR) Montaj talimatı

(RU) Инструкция по монтажу



SILKEBORG SI-83 L

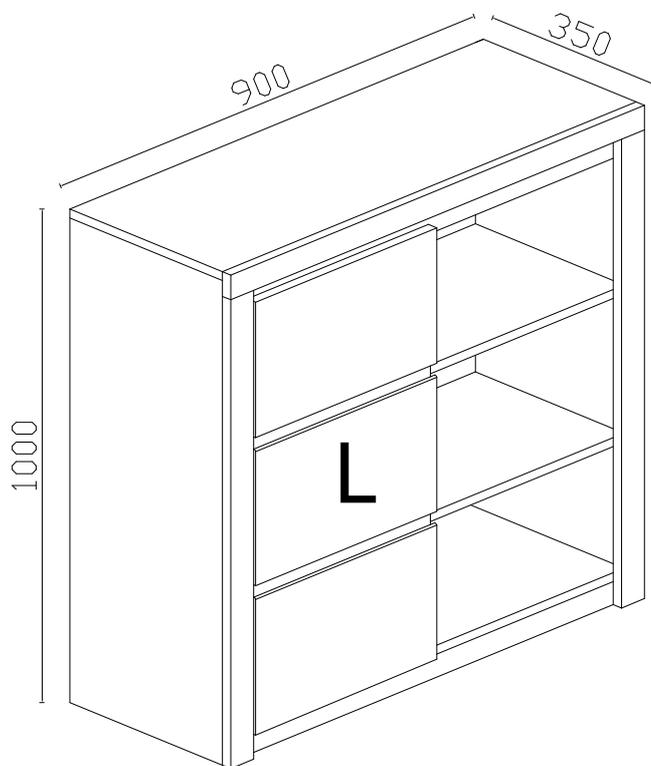

R ? L

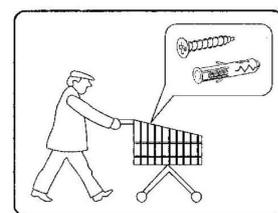
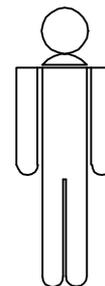

! Uwaga • Achtung • Attention • Caution • Figyele • Attenzione • Opgelet
Atentje • Upozornenie • Dikkat • Upozornění • Внимание **!**

(D) Bitte nur mit einem Staubtuch oder leicht feuchtem Lappen reinigen.
Keine scheuernden Putzmittel verwenden

(GB) Please only with a duster or a damp cloth.
Do not use any abrasive cleaners

(F) Le nettoyage se fait uniquement à l'aide d'un torchon ou d'une serviette
légèrement mouillée

(RO) Curățarea trebuie efectuată numai o cârpă sau cu un prosop ușor umezit
Nu utilizați agenți de curățare abrazivi

(I) Pulire esclusivamente con un panno o un asciugamano umido

(NL) Reinig alleen met een stofdoek of een lichtjes vochtige doek
Gebruik geen schurende poetsmiddelen

(PL) Czyszczenie należy wykonać wyłącznie za pomocą ściereczki lub lekko nawilżonego
ręcznika. Nie stosować środków czyszczących do szorowania

(TR) Lütfen sadece bir toz beziyile veya hafif nemli yumuşak bir bezle siliniz.
Aşındırıcı temizlik malzemeleri kullanmayınız

(CZ) Čistění je nutné vykonávat výhradně pomocí utěrky nebo lehce navlhčeného ručníku.
Nepoužívejte čističí prostředky obsahující abrazivní částice

(SK) Čistení je nutné vykonávať výhradne pomocí utierky alebo ľahko zvlhnutým ručníkom
Nepoužívajte čistiaci prostriedky obsahujúci abrazívni častice

(HU) A tisztítás kizárólag törölrőruha vagy enyhén nedvesített törölköző segítségével végezhető.
Súroló hatású tisztítószereket nem szabad használni

(RU) Очищайте от пыли тряпкой или слегка влажной ветошью. Не допускается применение
чистящих средств, не пред-назначенных для ухода за мебелью.

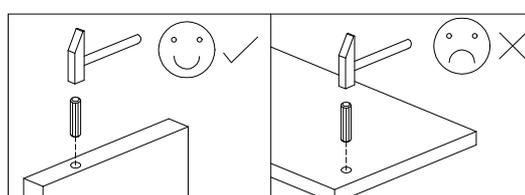
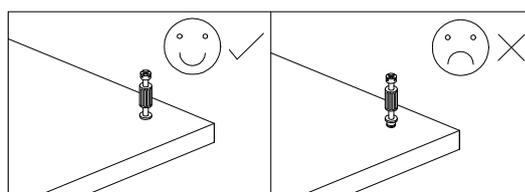
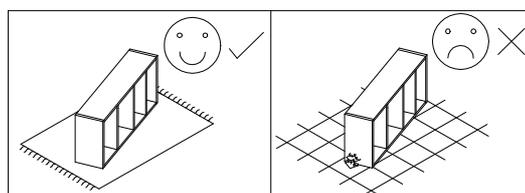
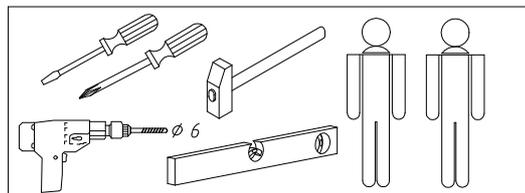

(D) Servicekarte

(RO) Carte de service

(PL) Karta serwisowa

(SK) Služobný preukaz

(GB) Service card

(I) Carta di servizio

(TR) Servis karti

(HU) Szerviz kártya

(F) Carte de service

(NL) Dienst kaart

(CZ) Servisni karta

(RU) Сервисная карта

SILKEBORG SI-83 L

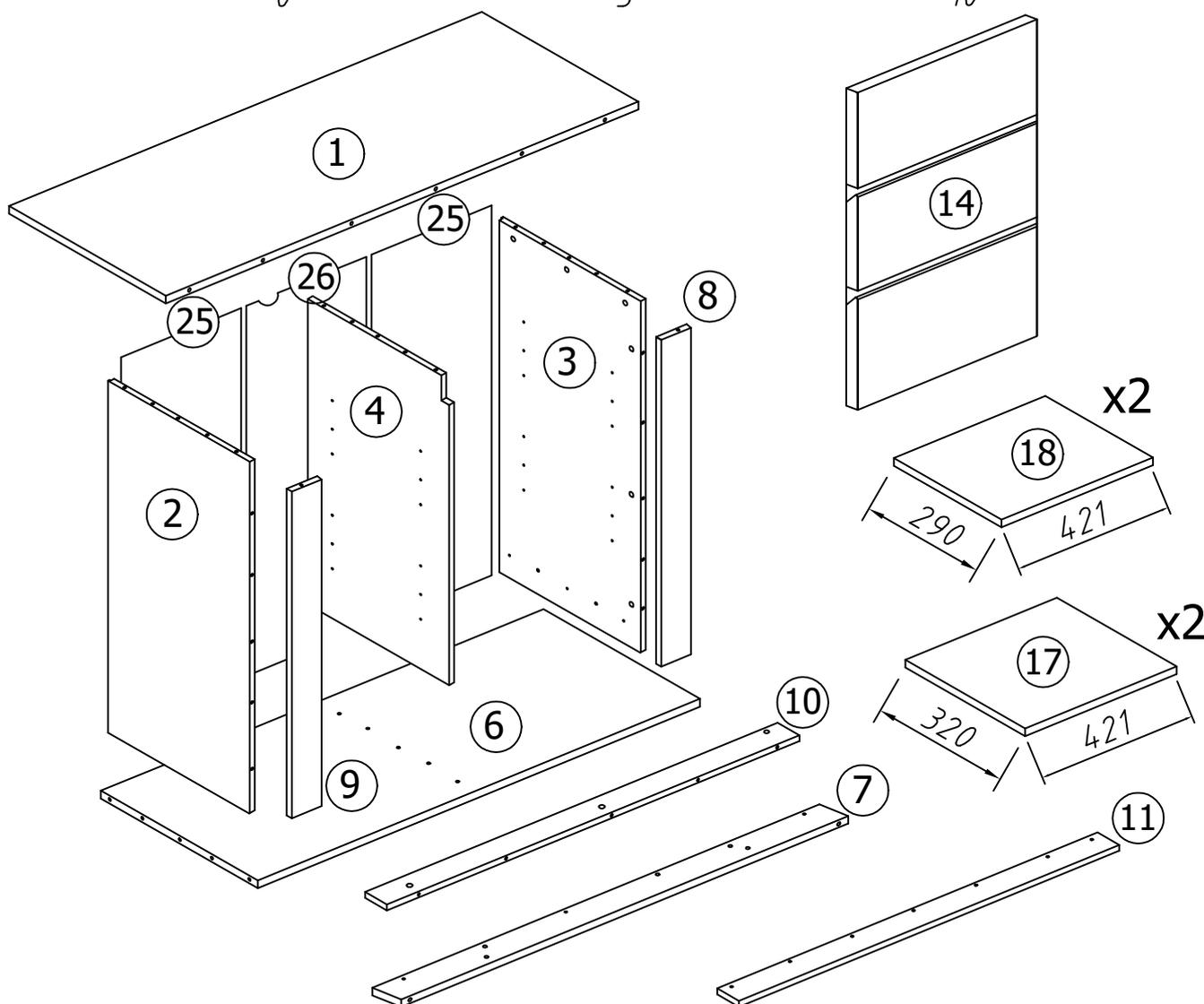
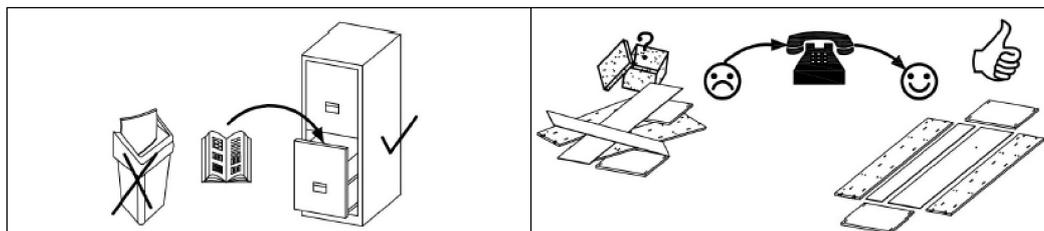

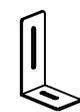
| | | | | | | | | | |
|--|---|---|---|---|---|--|--|--|---|
| (A)  x30 | (B)  x30 | (C)  x19 | (D) $\phi 8 \times 30$  x20 | (E)  x16 | (J)  x2 | (K)  x1 | (N)  x3 | (R)  x40 | (AB) $\phi 3,5 \times 16$  x4 |
| (AV)  x1 | (BO) $\phi 4 \times 25$  x5 | (BW) $\phi 6 \times 30$  x1 | (CB) $\phi 6,3 \times 13$  x4 | (CP) $\phi 4 \times 16$  x1 | (DZ) $\phi 8 \times 20$  x2 | (DB) $\phi 4 \times 40$  x1 | (FG)  x4 | (FS)  x2 | (ZG) $\phi 35$  x2 |
| (ZS)  x2 | | | | | | | | | |

B

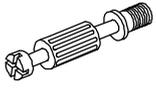

x6

D

∅8x30

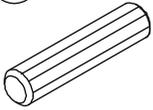

x12

1

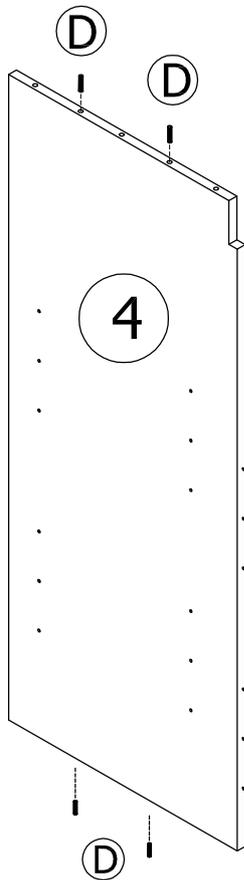
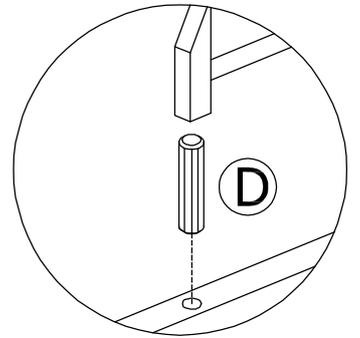
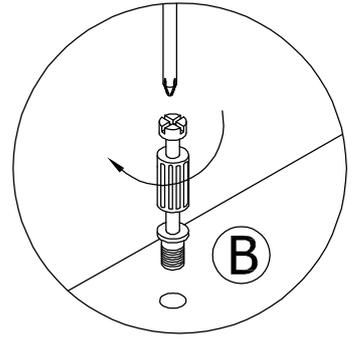
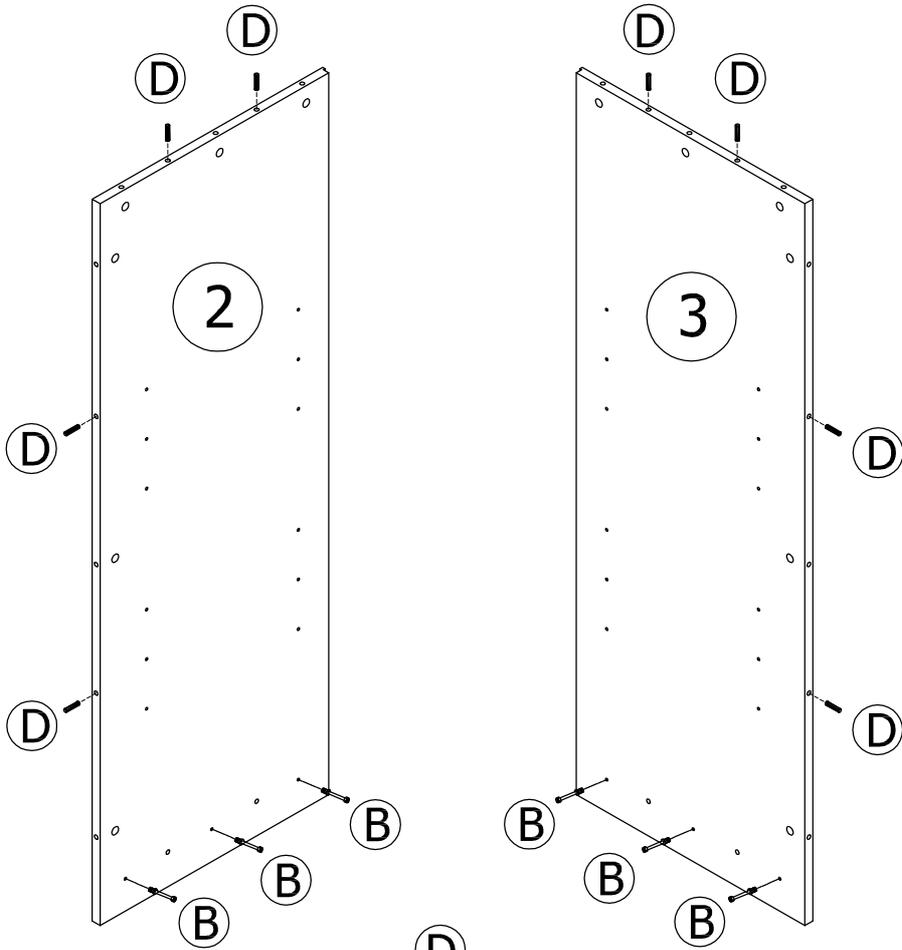

3

B

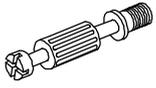

x12

D

∅8x30

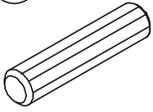

x8

2

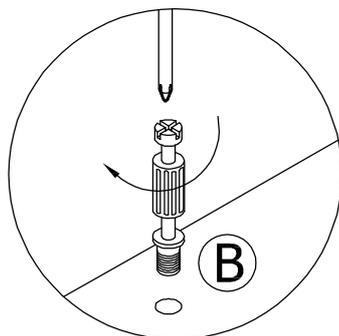
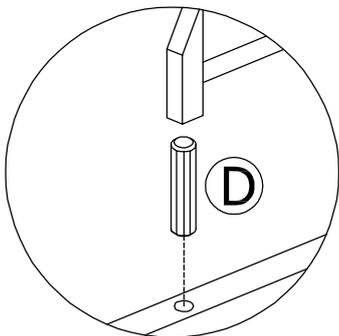
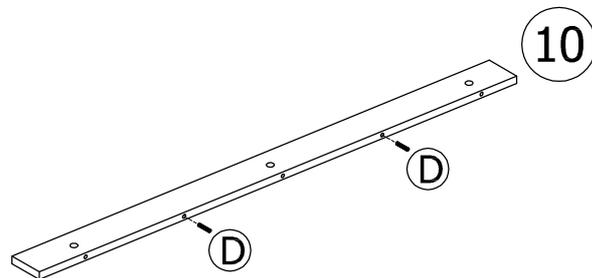
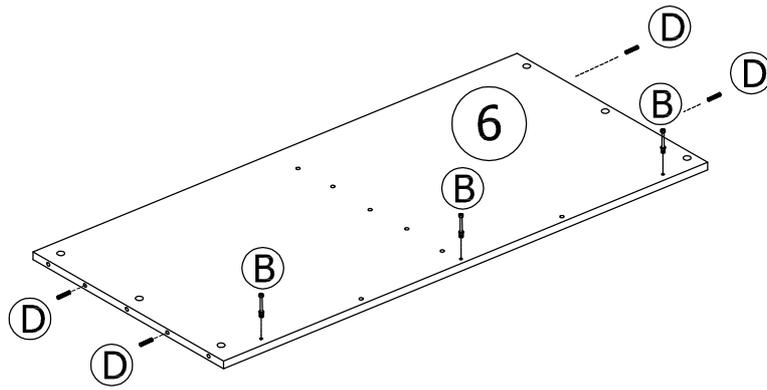
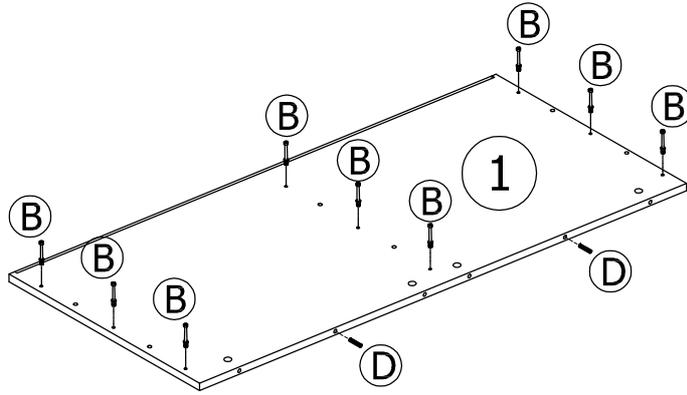

4

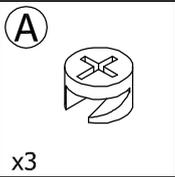

3

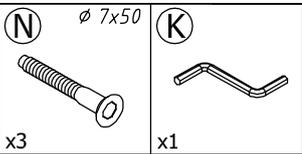
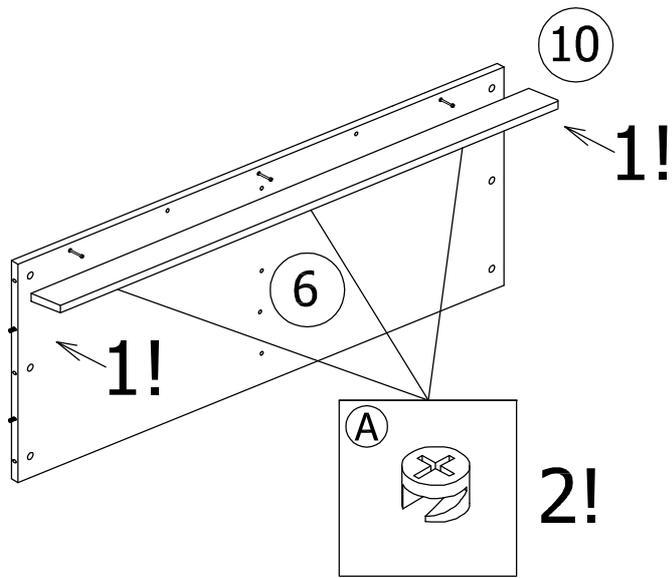

4

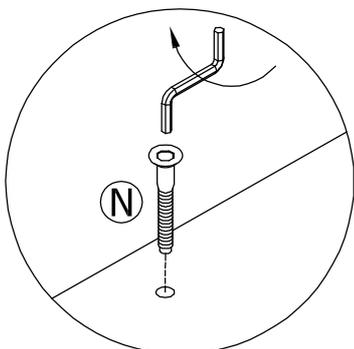
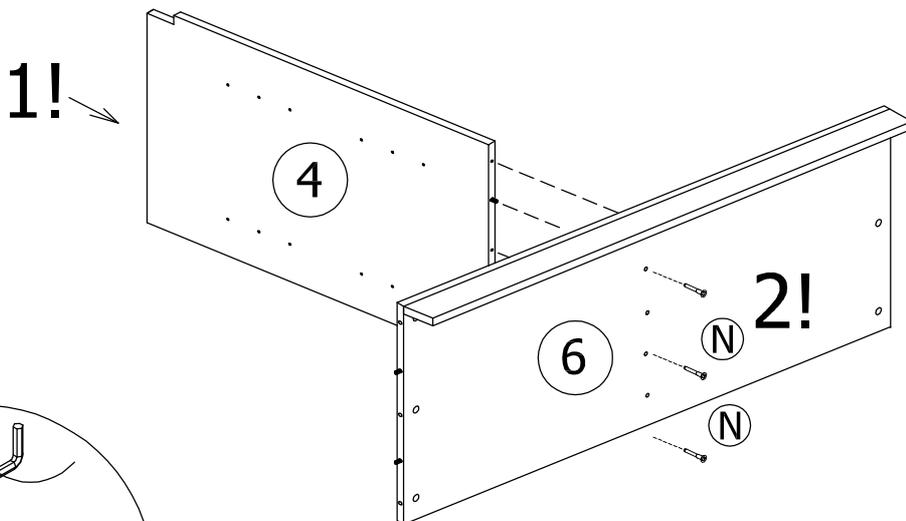

5

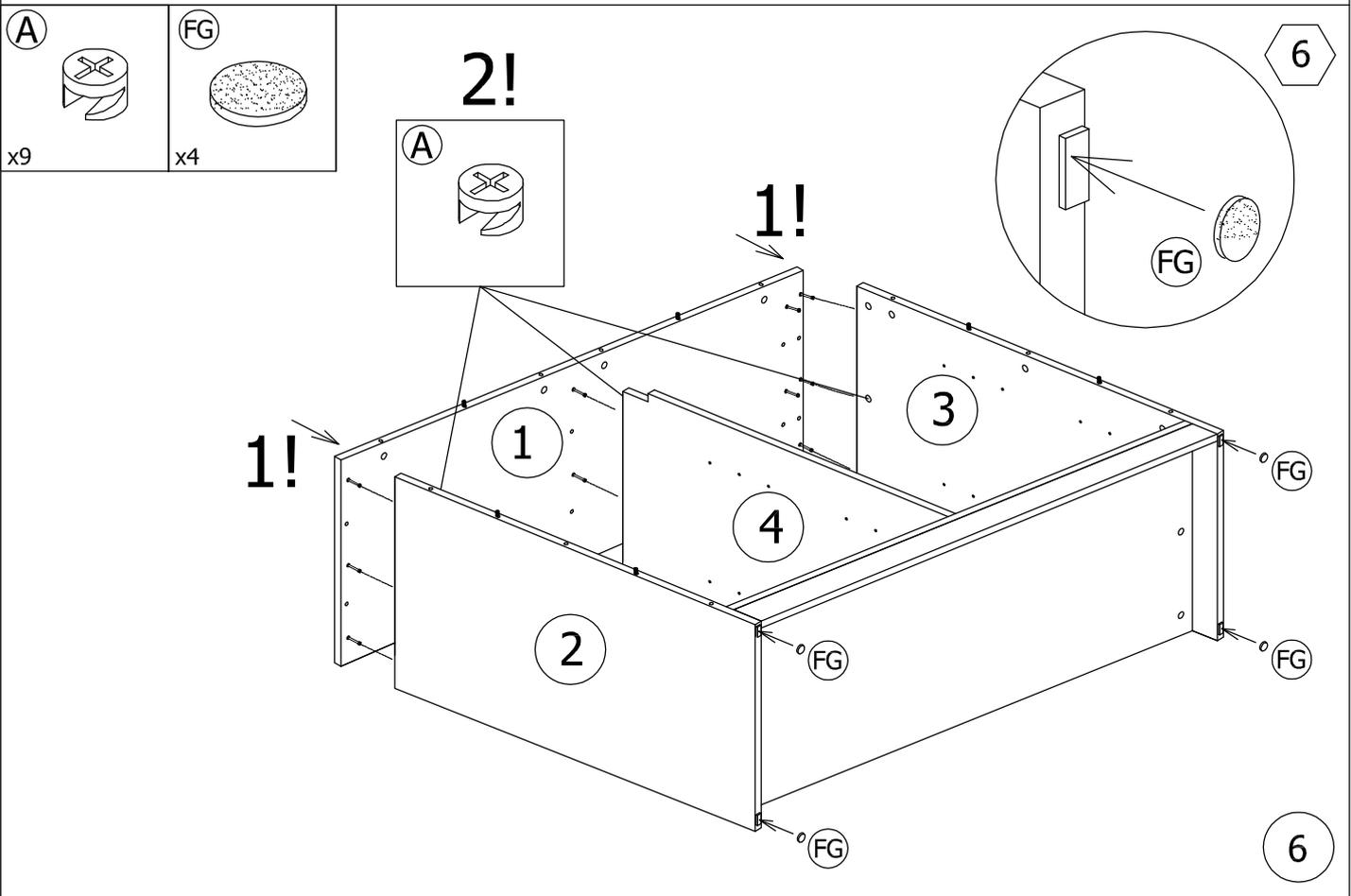
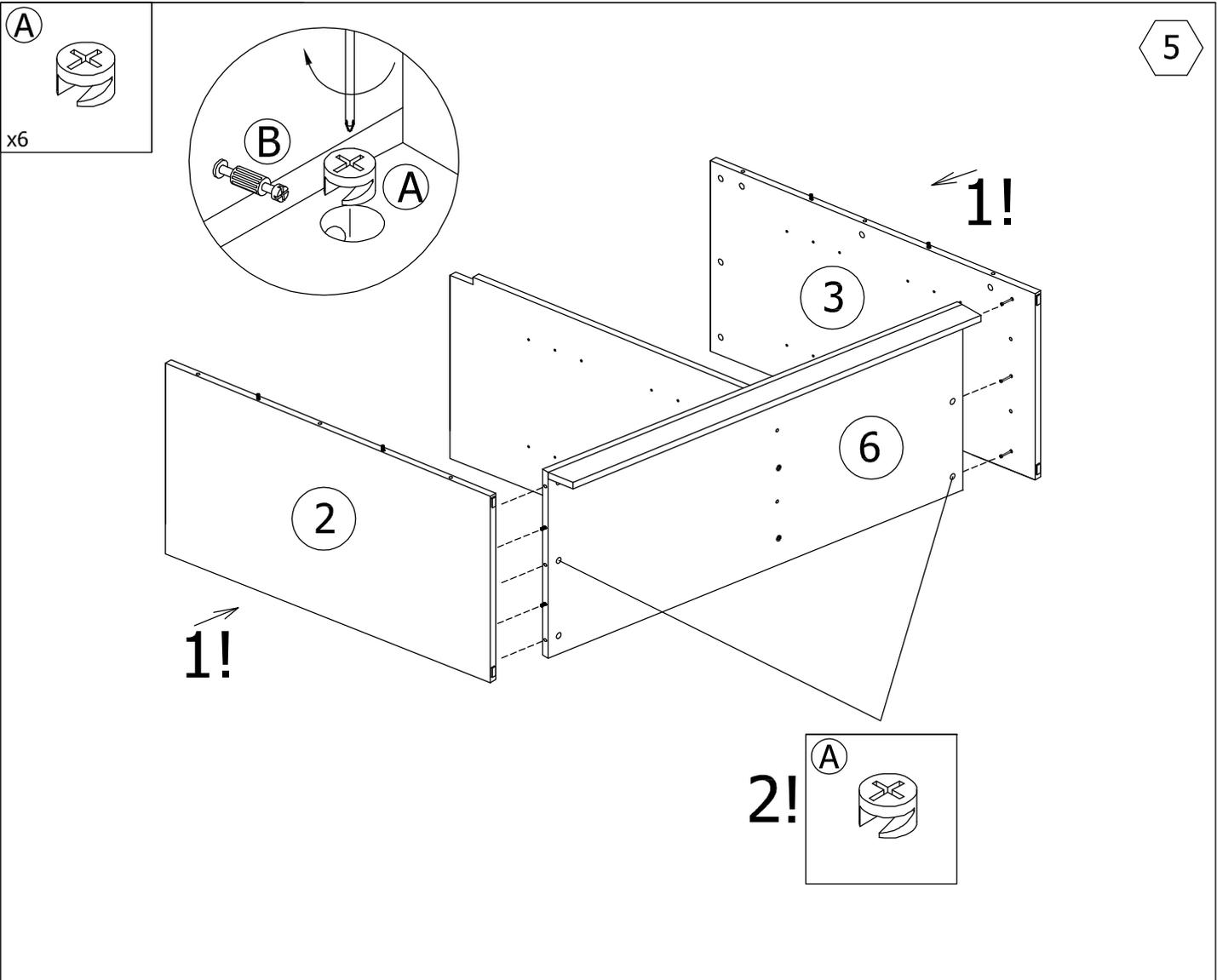

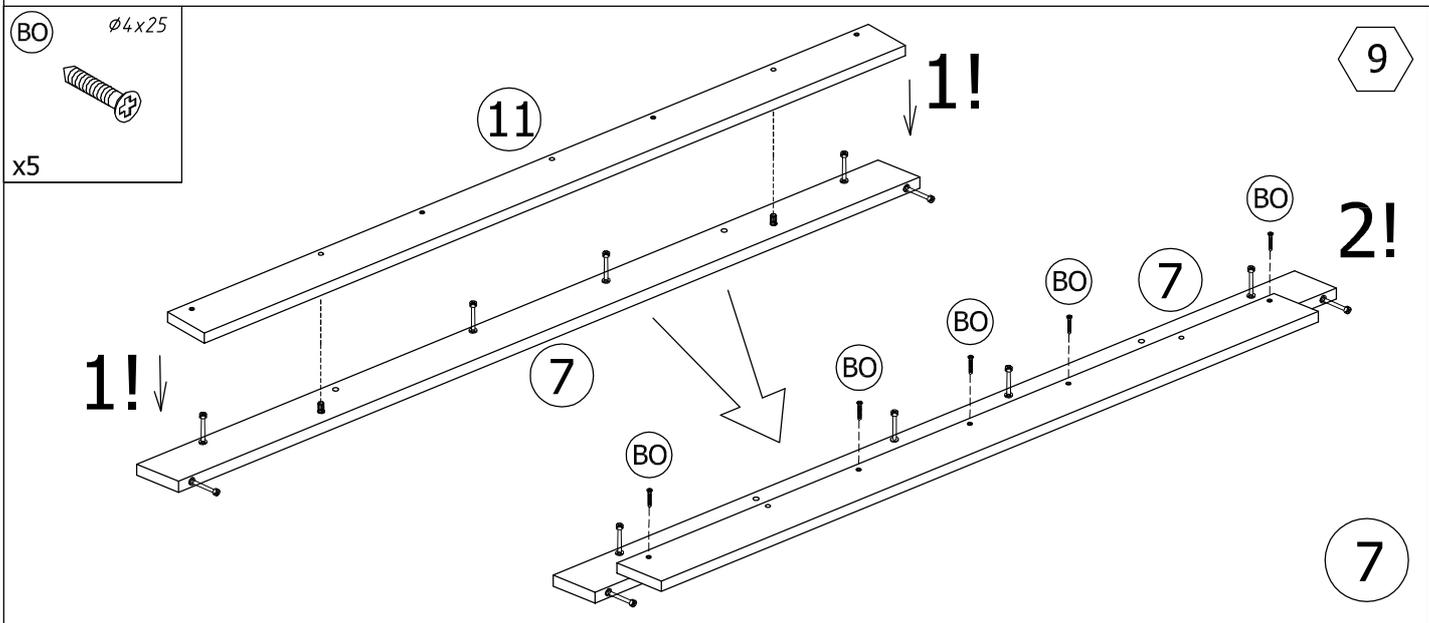
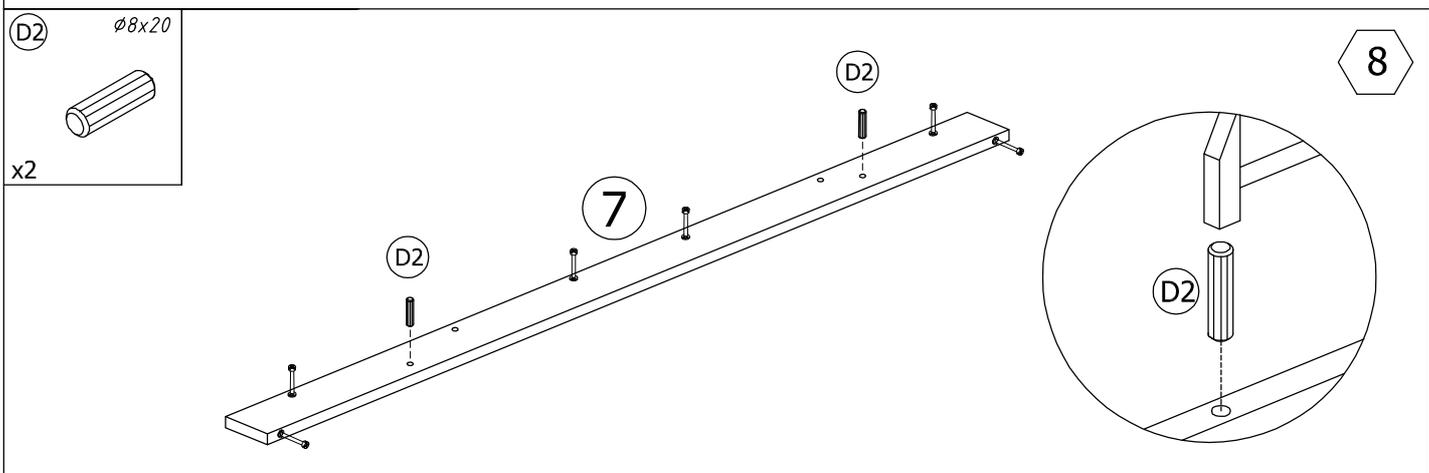
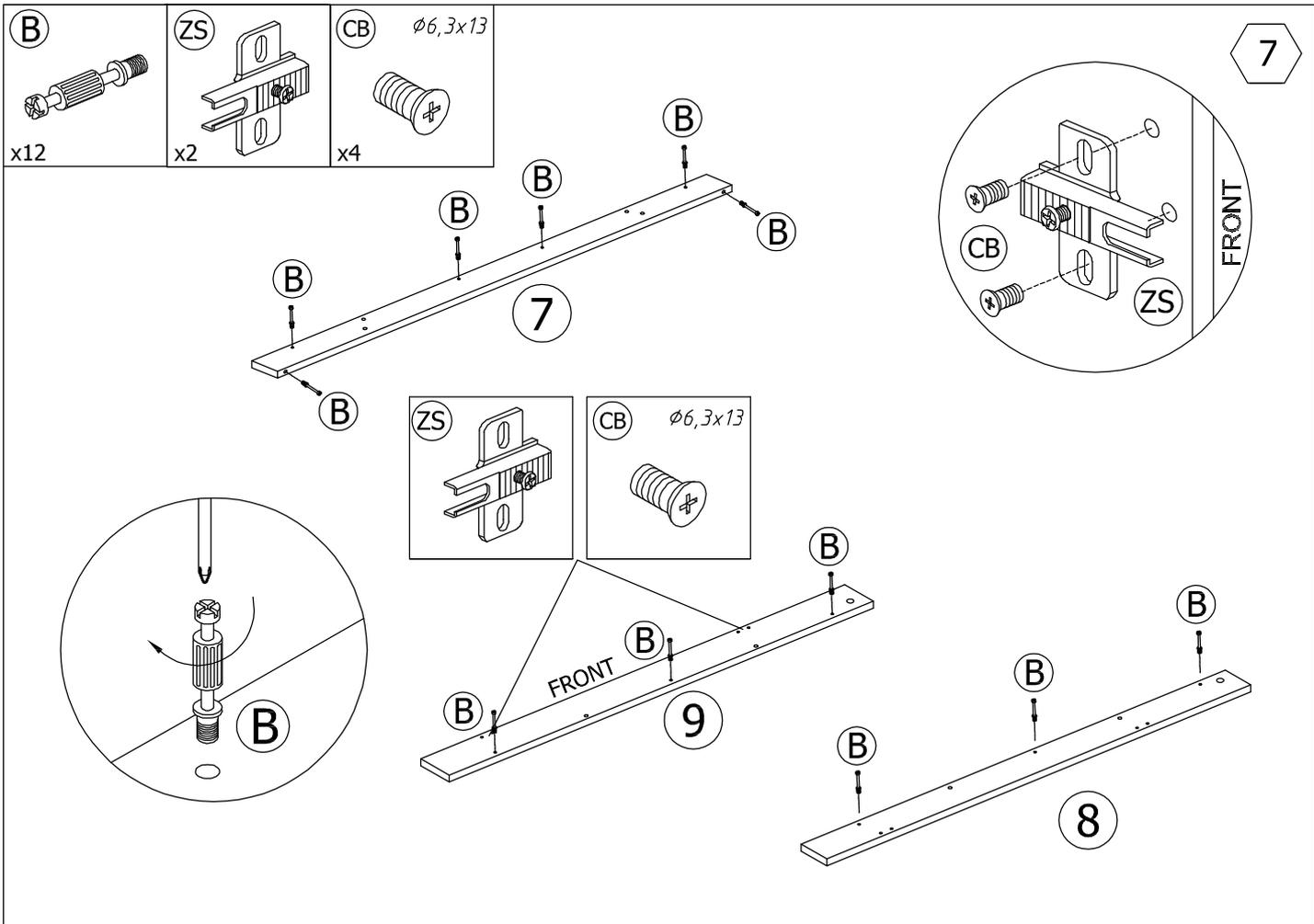

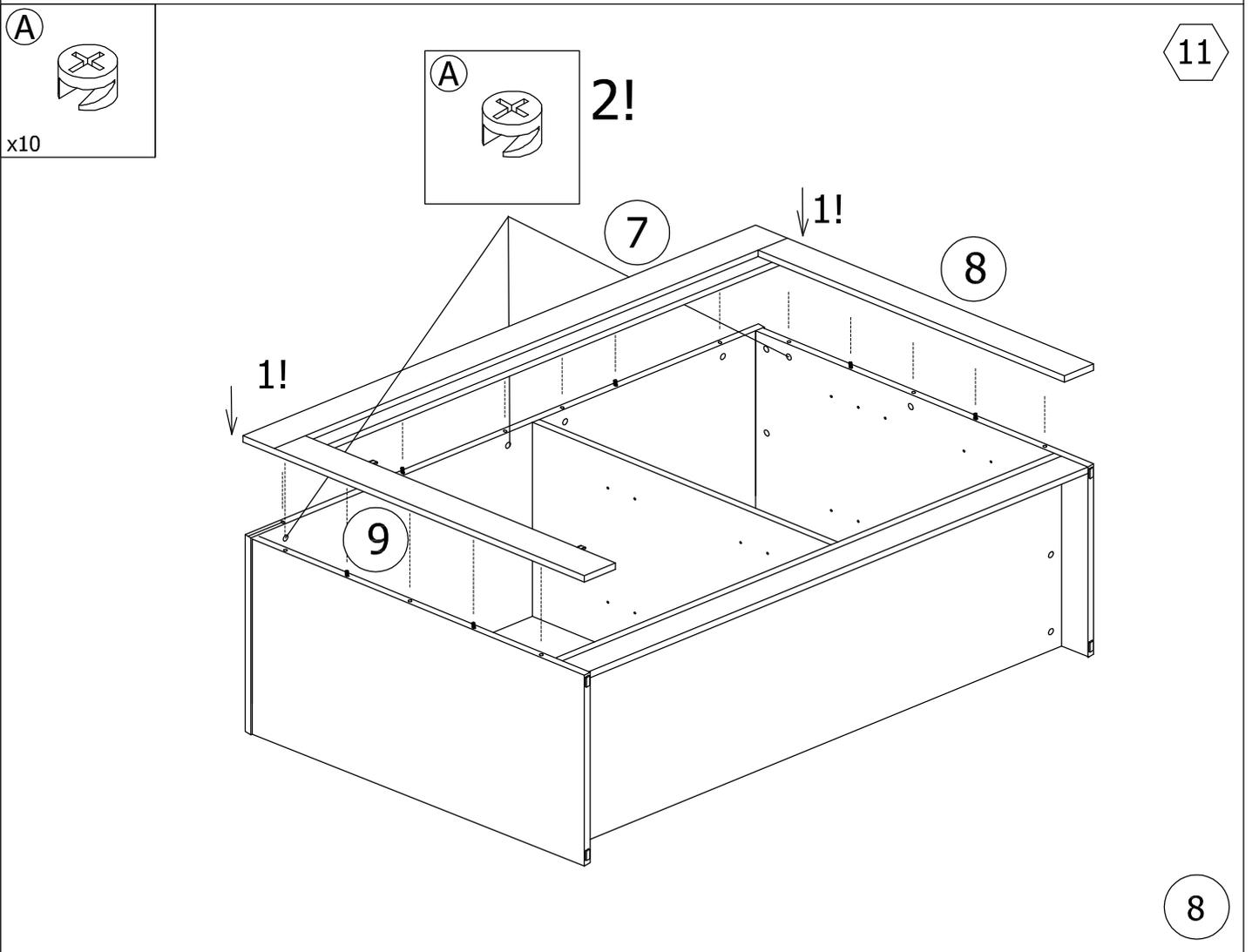
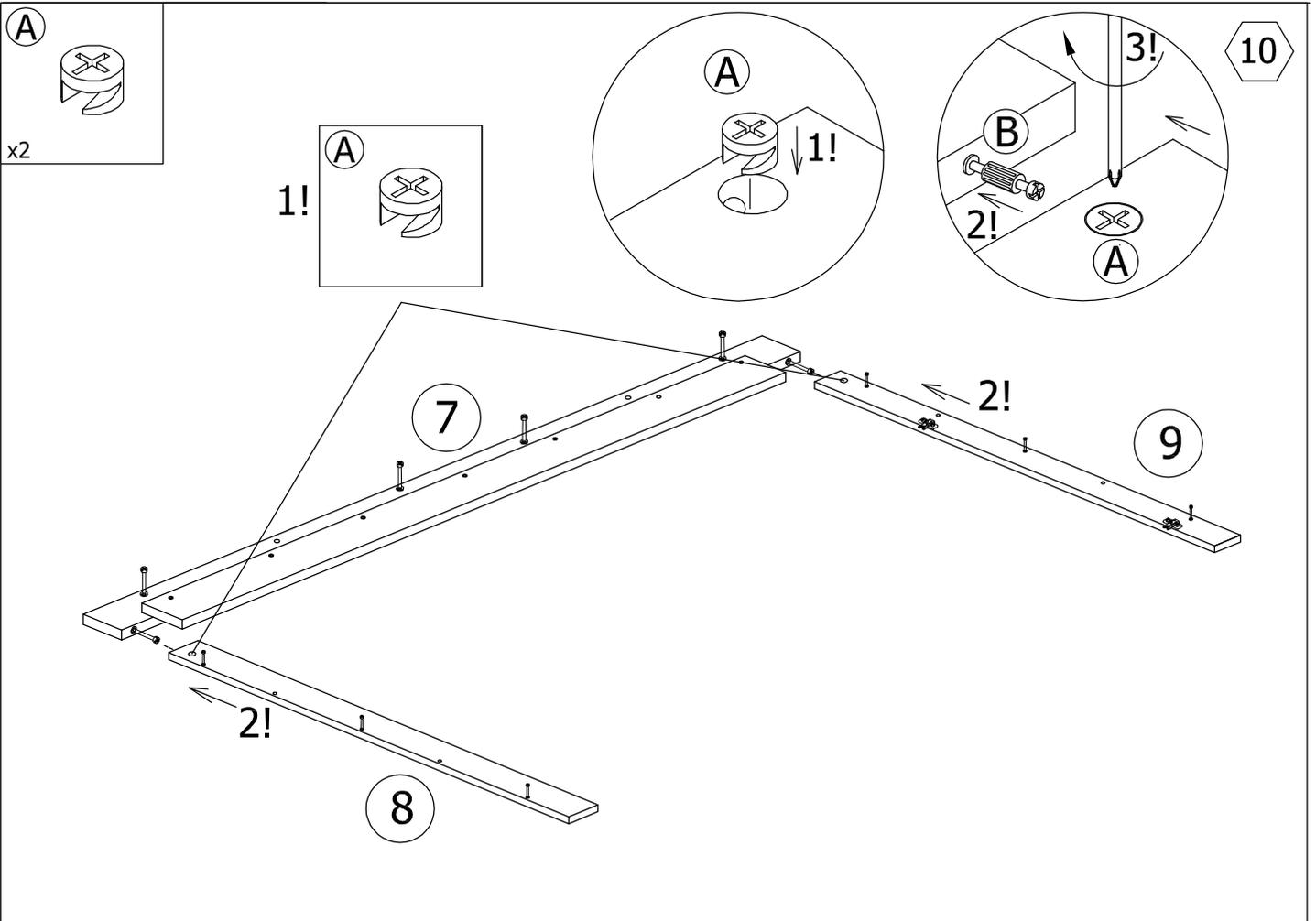

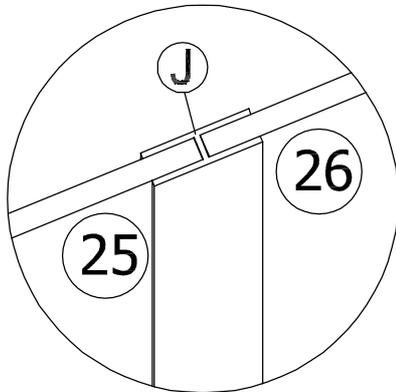
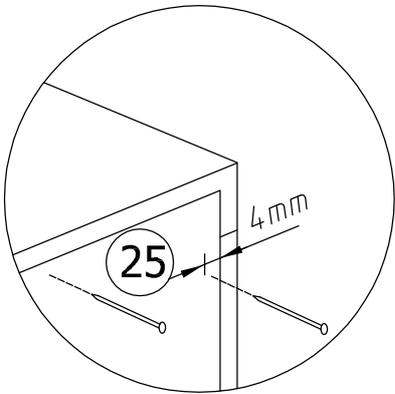
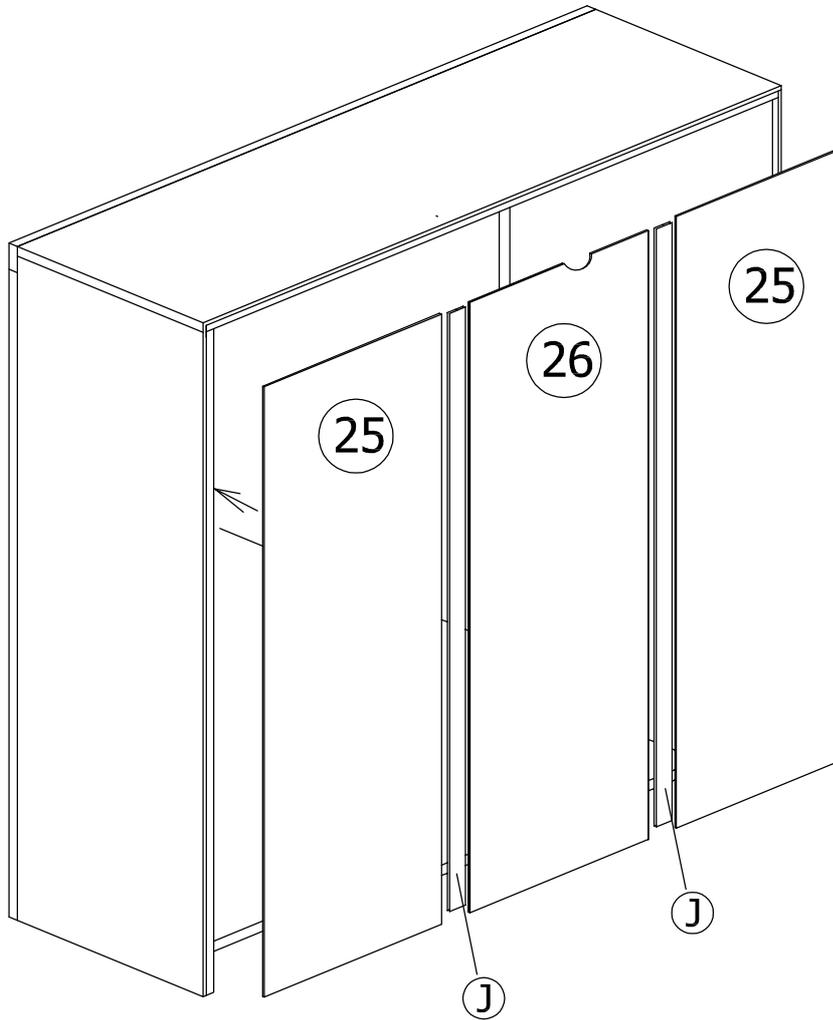
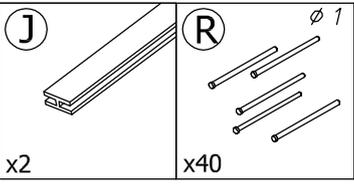

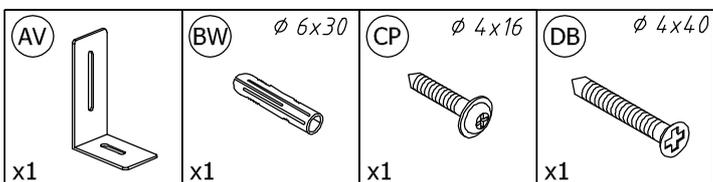

13

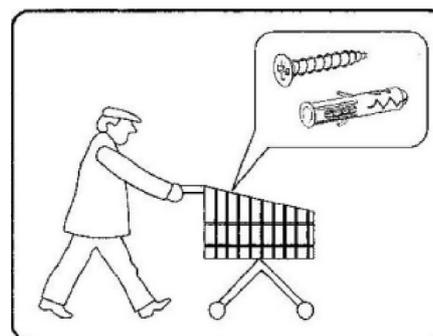
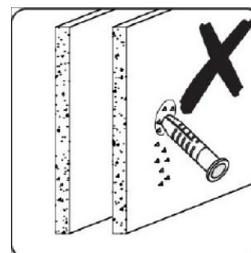
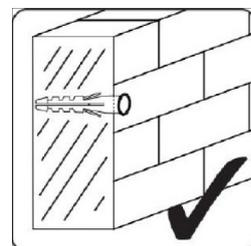
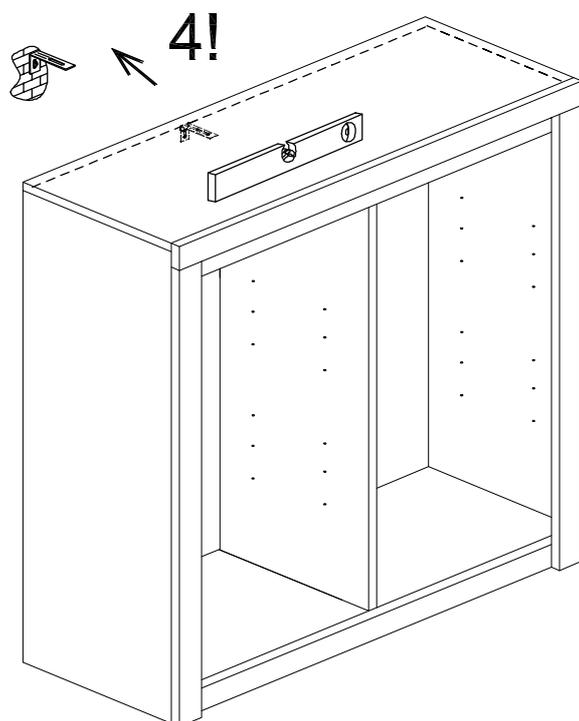
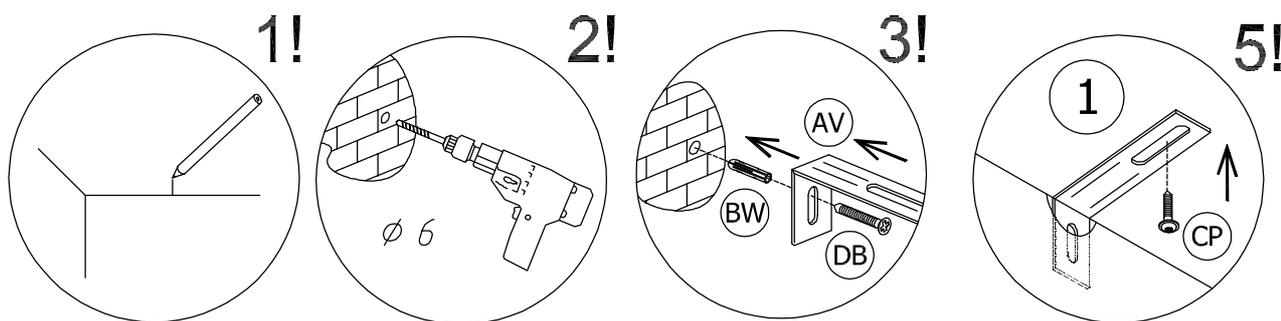

| Uwaga • Achtung • Attention • Caution • Figyele • Attenzione • Opgelet , Atentie • Upozornenie • Dikkat • Upozornini • Внимание | |
|--|--|
| D | Die Befestigung des Möbelsstückes an der Wand muss von einer fachkundigen Person vorgenommen werden, da für die Montage an die Wand angepasste Dübel erforderlich sind |
| GB | A qualified professional is required when mounting furniture to the wall since dowels corresponding to the wall are required for this |
| F | Le montage du meuble au mur peut être fait uniquement par le personnel spécialisé. Il est nécessaire d'utiliser des chevilles bien ajustées pendant le montage au mur. |
| RO | Montarea mobilei pe poate fi efectuată numai de către personalul calificat deoarece la această montare se folosește cepuri. |
| I | Attaccare un alla parete può essere effettuato esclusivamente dal personale adatto perché durante il montaggio bisogna usare dei cavicchi adatti. |
| NL | een vakkundige persoon dient het meubelstuk aan de muur te bevestigen; voor de montage aan de muur zijn immers aangepaste pluugen vereist |
| PL | Mocowanie do ściany może przeprowadzić wyłącznie odpowiedni do tego personel, ponieważ w czasie montażu w ścianie konieczne jest zastosowanie dopasowanych kołków |
| TR | Möbilya parçasının duvara sabitlenmesi, duvar montajı için özel uyarlanmış dübeller gerektirdiğinden bu iş sadece bu konuda uzman bir kişi tarafından gerçekleştirilmelidir. |
| CZ | Připevnění nábytku ke stěně může uskutečnit výhradně k tomu určený personál, protože pro montáž je nutné použít hmoždinky shodné s typem a tloušťkou stěny. |
| SK | Pripnenie nábytku k stene môže uskutočniť výhradne k tomu určený personál, pretože k montáži je nutné použiť hmoždinky zhodné s typom steny a jej hrúbkou |
| HU | A bútor a falhoz való rögzítését kizárólag erre illetékes személyzet végezheti, mivel a falhoz való rögzítés során megfelelő méretű csapszeg alkalmazása szükséges. |
| RU | Очищайте от пыли тряпкой или слегка влажной ветошью. Не допускается применение чистящих средств, не предназначенных для ухода за мебелью. |

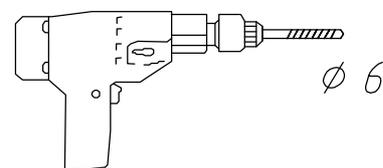
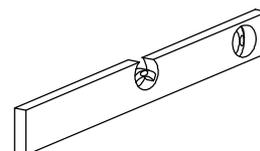

10

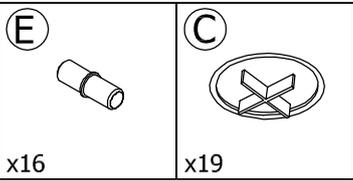

14

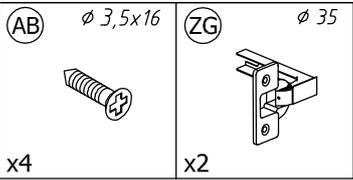
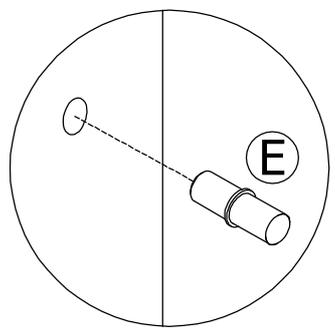
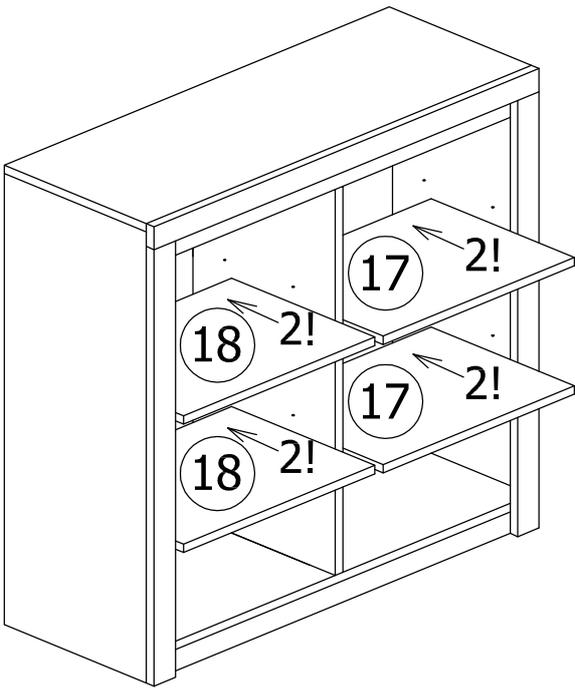
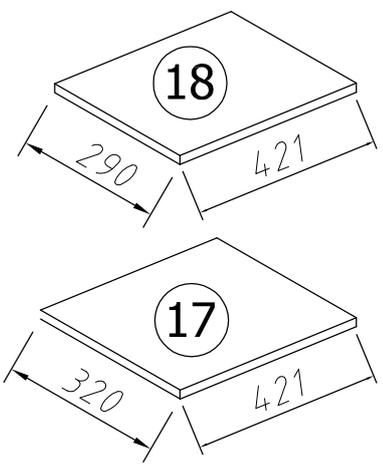
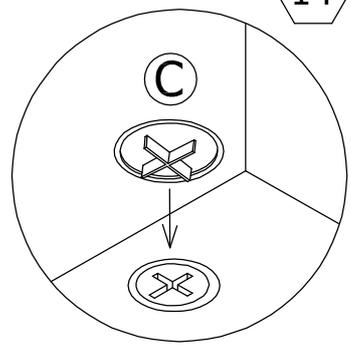

15

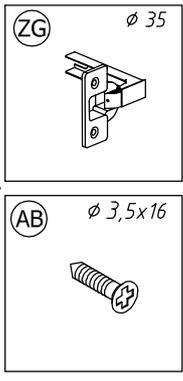
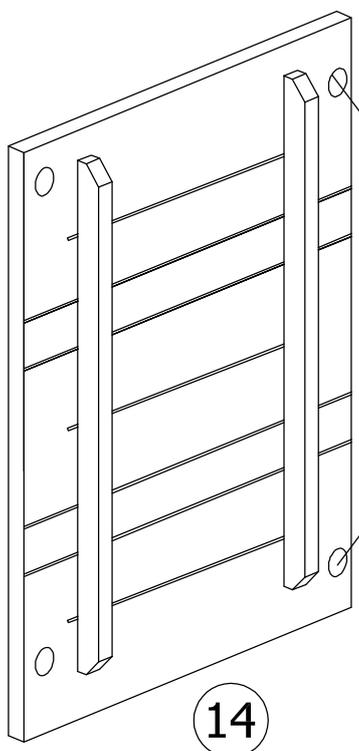
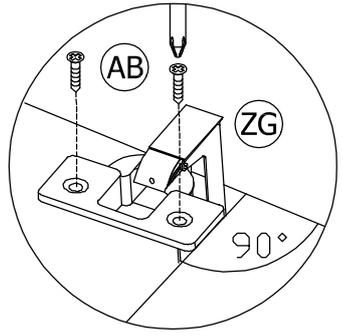

14

11

FS



x 2

16

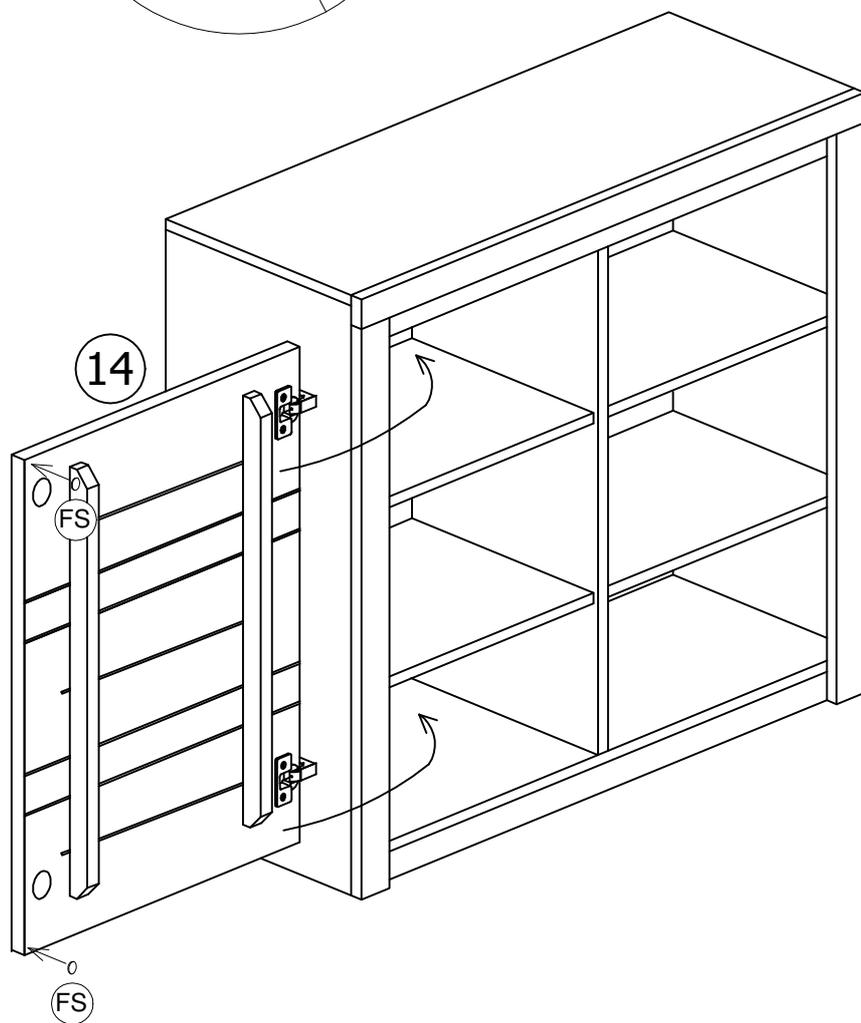
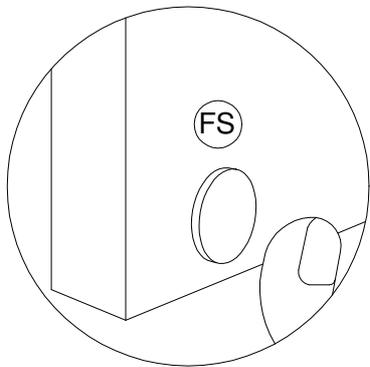

1!

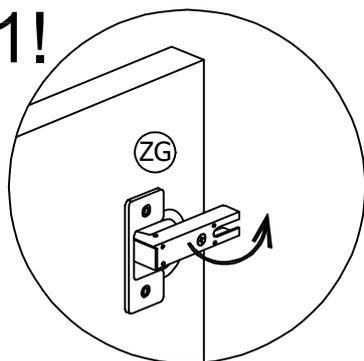

2!

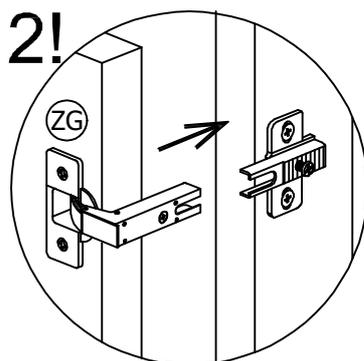

3!

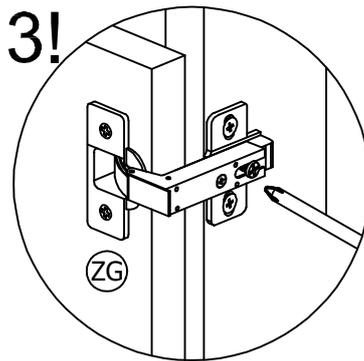

12

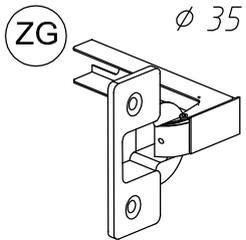

D Turen einstellen (Scharniere justieren)

GB Adjusting the doors (adjusting the hinges)

F Mettre la porte (égaliser les gonds)

RO Ajustați ușa (aliniați balamalele)

I Regolare la porta (livellare le parentesi)

NL Deuren instellen (scharnieren afstellen)

PL Nastawić drzwi (wyrównać zawiasy)

TR Kapıların ayarlanması (menteşelerin seviye ayarı)

CZ Seříd'te dveře (vyrovnajte závěsy)

SK Zrad'te dvere (vyrovnajte závesy)

HU Állítsa be az ajtót (igazítsa be a zsanérokát)

RU Регулировка дверей (регулировка шарнира)

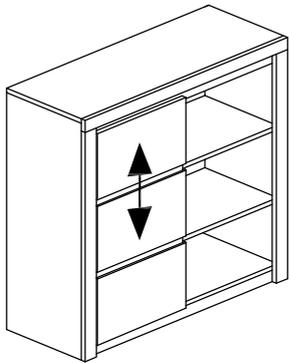

1!

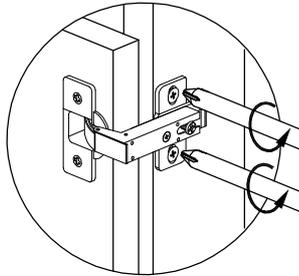

2!

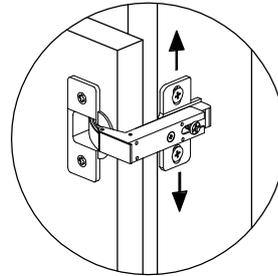

3!

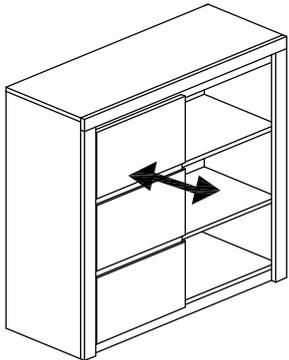
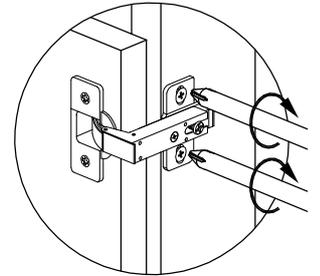

1!

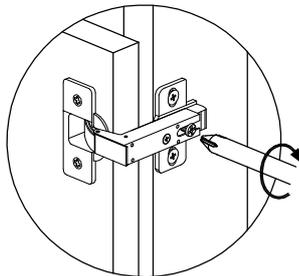

2!

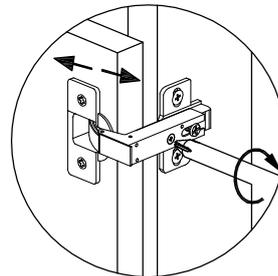

3!

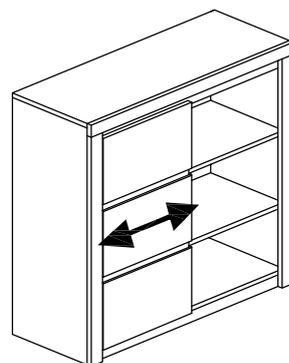
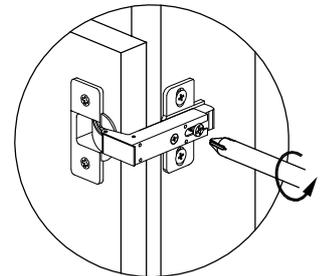

1!

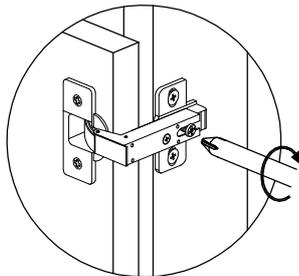

2!

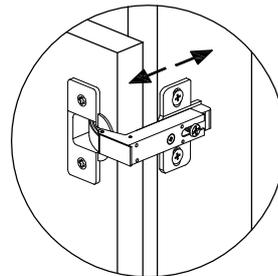

3!

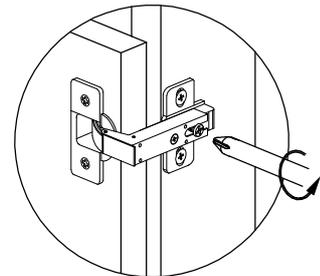

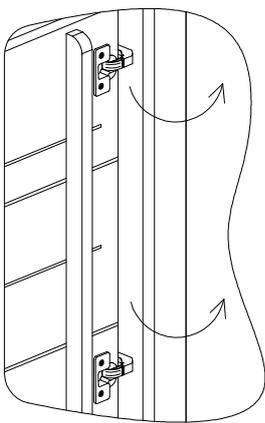
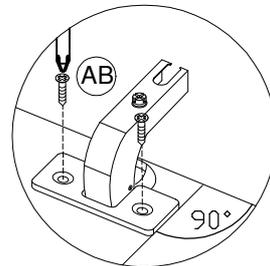
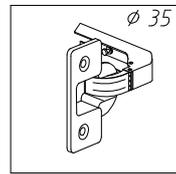
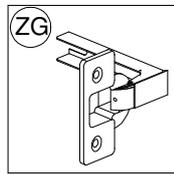
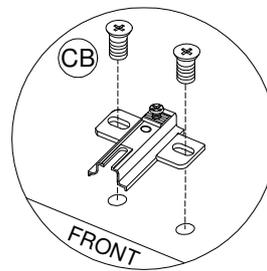
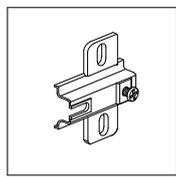
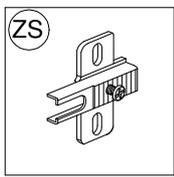

1!

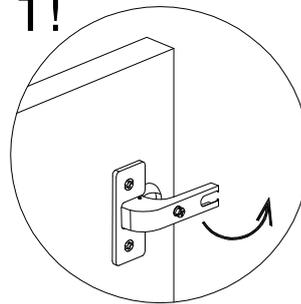

2!

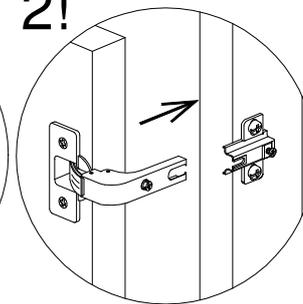

3!

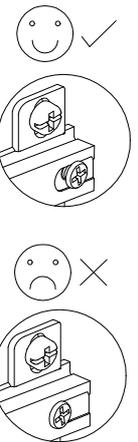
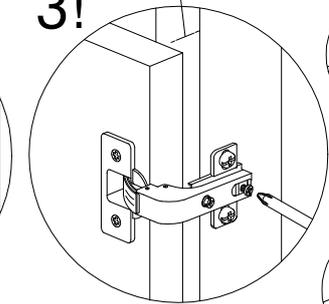

(D) Turen einstellen (Scharniere justieren)

(GB) Adjusting the doors (adjusting the hinges)

(F) Mettre la porte (égaliser les gonds)

(RO) Ajustați ușa (aliniați balamalele)

(PL) Nastawić drzwi (wyrównać zawiasy)

(TR) Kapıların ayarlanması (menteşelerin seviye ayarı)

(CZ) Seřídít dveře (vyrovnajte závěsy)

(SK) Zradít dveře (vyrovnajte závesy)

(I) Regolare la porta (livellare le parentesi)

(NL) Deuren instellen (scharnieren afstellen)

(HU) Állítsa be az ajtó (igazítsa be a zsanérokot)

(RU) Регулировка дверей (регулировка шарнира)

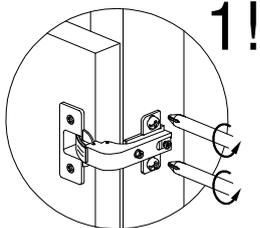

1!

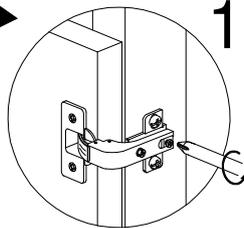

1!

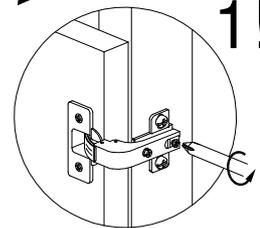

1!

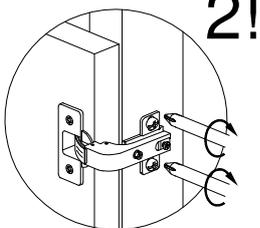

2!

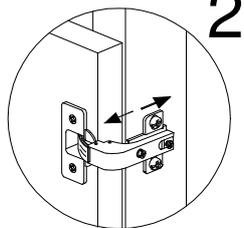

2!

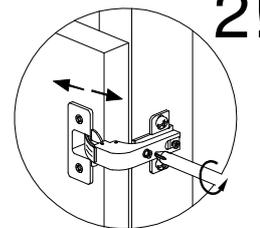

2!

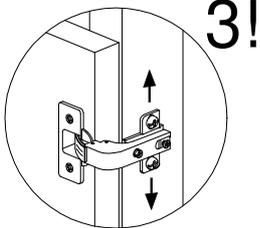

3!

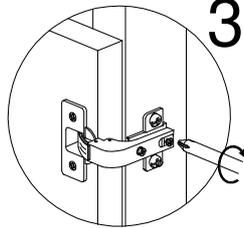

3!

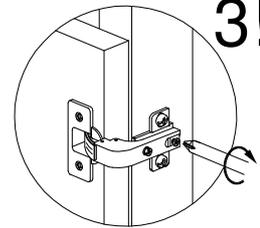

3!

(D) Montageanleitung

(I) Istruzioni di montaggio

(CZ) Montážní návod

LKZ 41194

(GB) Assembly instructions

(NL) Handleiding voor de montage

(SK) Návod na montáž

(F) Notice de montage

(PL) Instrukcja montażu

(HU) Szerelési útmutató

(RO) Instrucțiuni de montaj

(TR) Montaj talimatı

(RU) Инструкция по монтажу



SILKEBORG SI-25

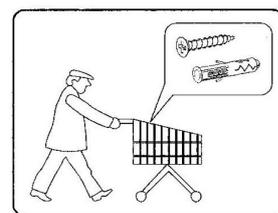
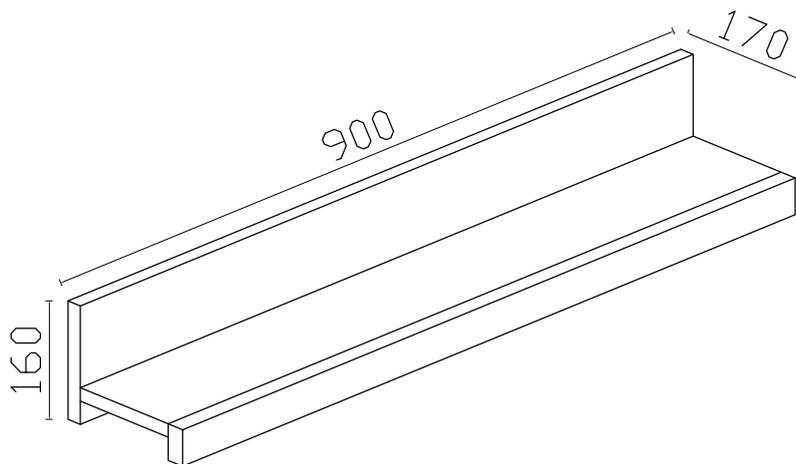

! Uwaga • Achtung • Attention • Caution • Figyele • Attenzione • Opgelet
Atentje • Upozornenie • Dikkat • Upozornini • Внимание **!**

(D) Bitte nur mit einem Staubtuch oder leicht feuchtem Lappen reinigen.
Keine scheuernden Putzmittel verwenden

(GB) Please only with a duster or a damp cloth.
Do not use any abrasive cleaners

(F) Le nettoyage se fait uniquement à l'aide d'un torchon ou d'une serviette
légèrement mouillée

(RO) Curățarea trebuie efectuată numai o cârpă sau cu un prosop ușor umezit
Nu utilizați agenți de curățare abrazivi

(I) Pulire esclusivamente con un panno o un asciugamano umido

(NL) Reinig alleen met een stofdoek of een lichtjes vochtige doek
Gebruik geen schurende poetsmiddelen

(PL) Czyszczenie należy wykonać wyłącznie za pomocą ściereczki lub lekko nawilżonego
ręcznika. Nie stosować środków czyszczących do szorowania

(TR) Lütfen sadece bir toz beziyile veya hafif nemli yumuşak bir bezle siliniz.
Aşındırıcı temizlik malzemeleri kullanmayınız

(CZ) Čistění je nutné vykonávat výhradně pomocí utěrky nebo lehce navlhčeného ručníku.
Nepoužívejte čističí prostředky obsahující abrazivní částice

(SK) Čistení je nutné vykonávať výhradne pomocí utierky alebo ľahko zvlhnutým ručníkom
Nepoužívajte čistiaci prostriedky obsahujúci abrazívni častice

(HU) A tisztítás kizárólag törölruha vagy enyhén nedvesített törülköző segítségével végezhető.
Súroló hatású tisztítószerket nem szabad használni

(RU) Очищайте от пыли тряпкой или слегка влажной ветошью. Не допускается применение
чистящих средств, не пред-назначенных для ухода за мебелью.

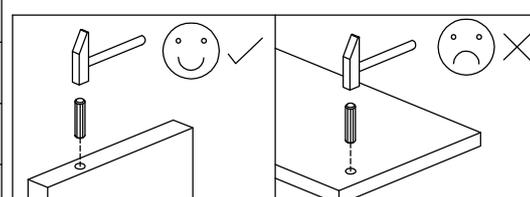
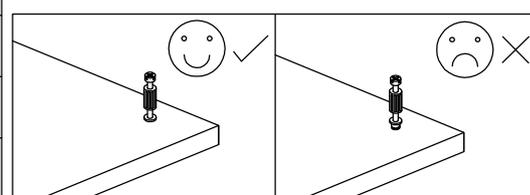
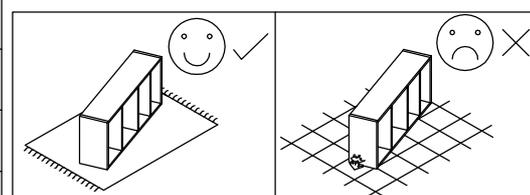
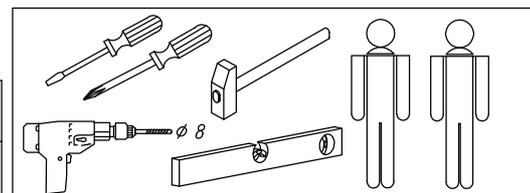

(D) Servicekarte

(RO) Carte de service

(PL) Karta serwisowa

(SK) Služobný preukaz

(GB) Service card

(I) Carta di servizio

(TR) Servis karti

(HU) Szerviz kártya

(F) Carte de service

(NL) Dienst kaart

(CZ) Servisni karta

(RU) Сервисная карта

SILKEBORG SI-25

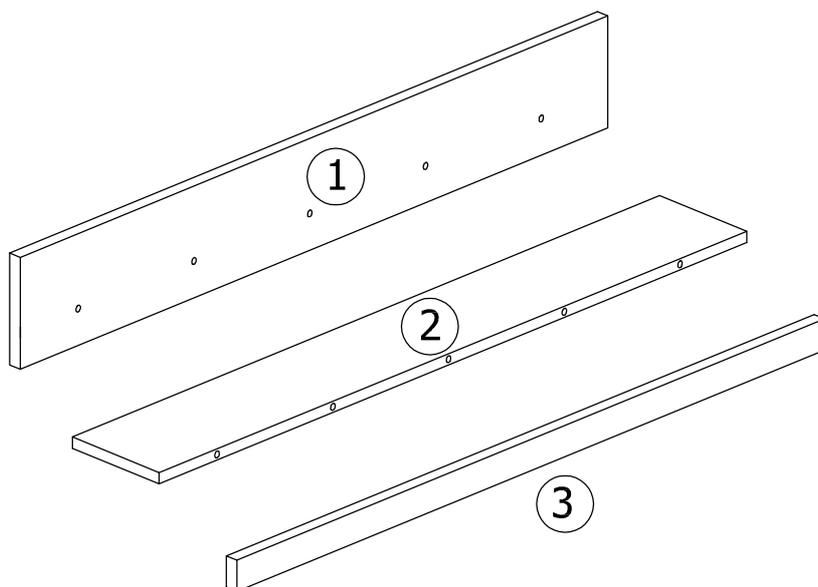
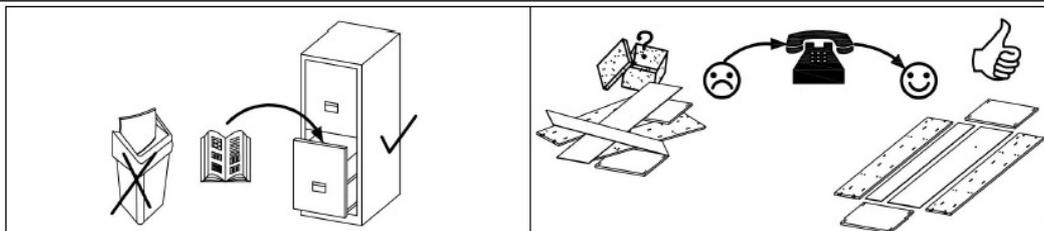

| | | | | | | |
|-----------------------|--------------------------------|---|--|----------------------|----------------------|-----------------------|
| <p>(A)</p> <p>x3</p> | <p>(B)</p> <p>x3</p> | <p>(C)</p> <p>x3</p> | <p>(D)</p> <p>$\phi 8$ x4</p> | <p>(K)</p> <p>x1</p> | <p>(N)</p> <p>x3</p> | <p>(BK)</p> <p>x2</p> |
| <p>(BL)</p> <p>x2</p> | <p>(BM)</p> <p>8x40 x2</p> | <p>(BN)</p> <p>$\phi 4 \times 13$ x4</p> | | | | |

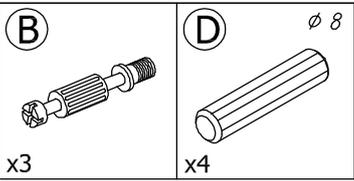

1

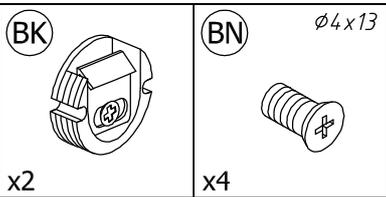
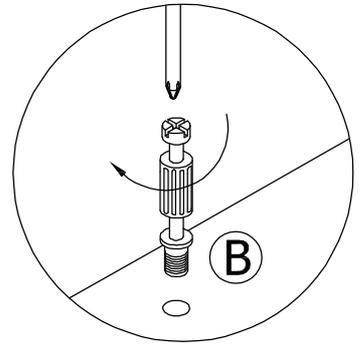
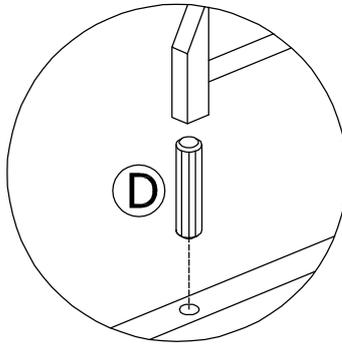
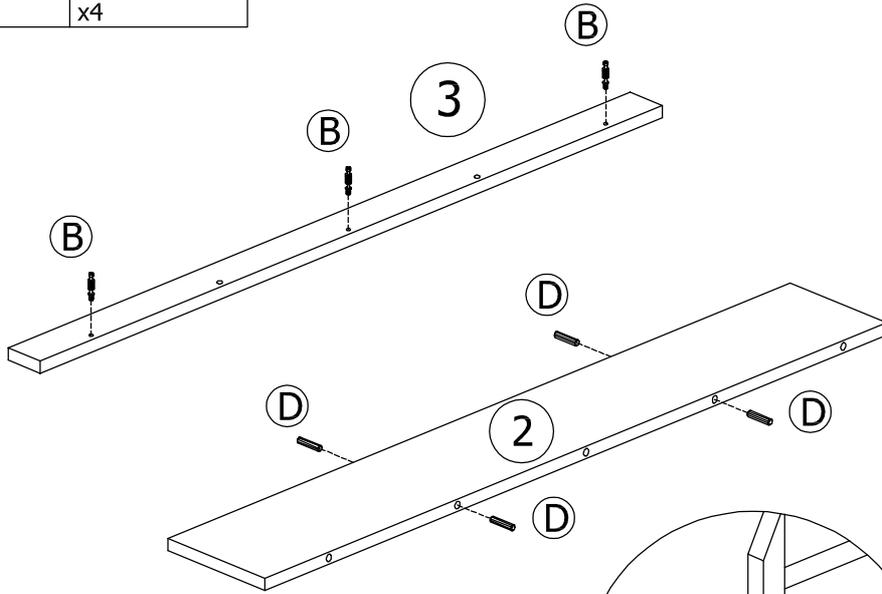

2

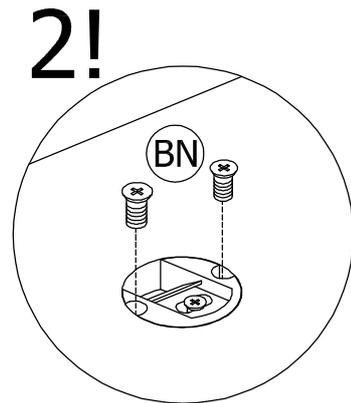
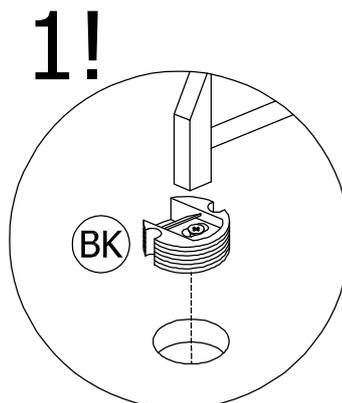
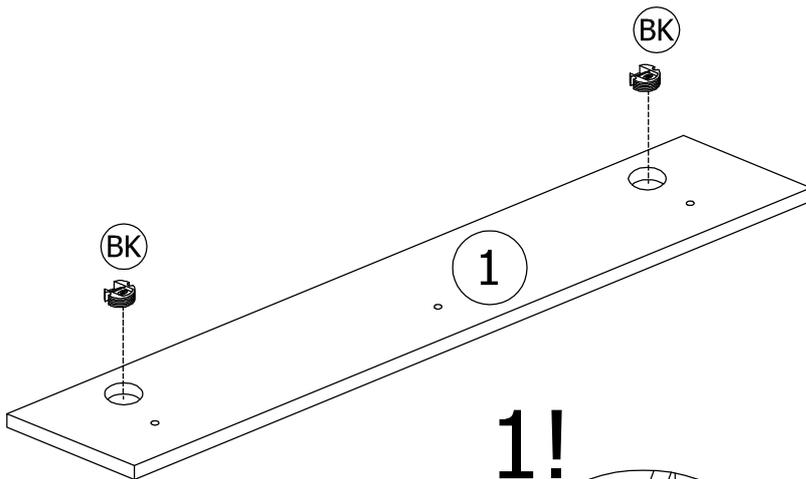

3

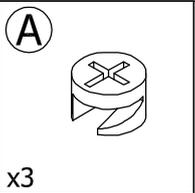

3

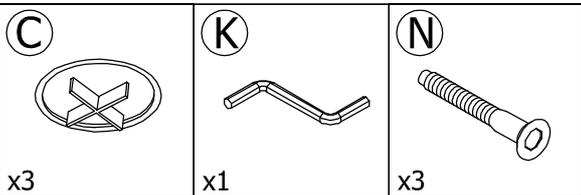
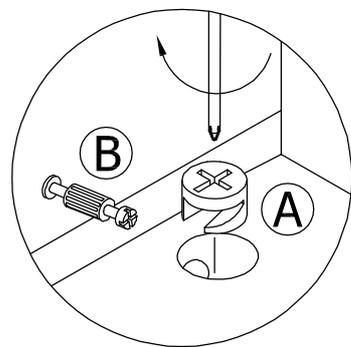
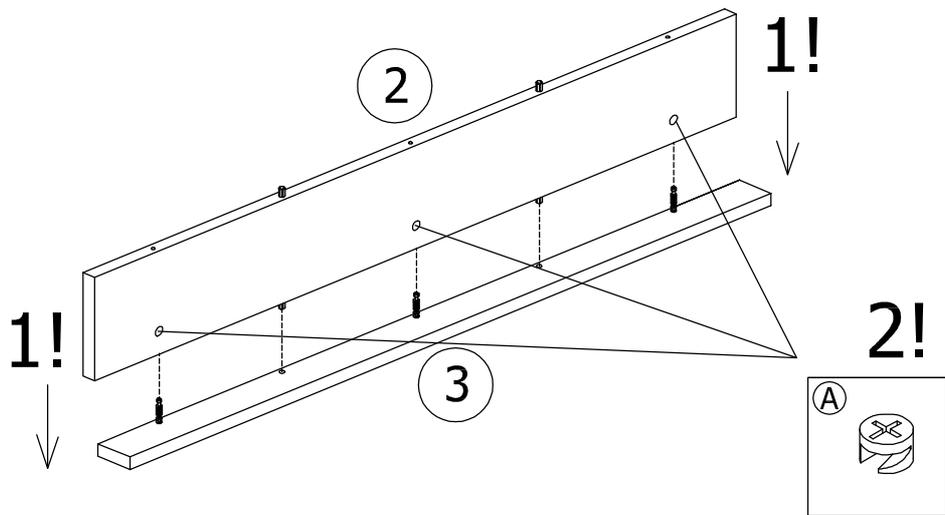

4

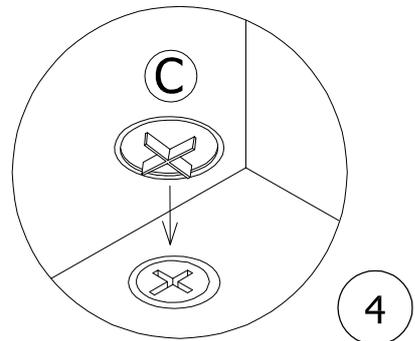
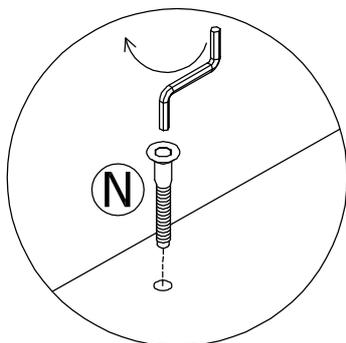
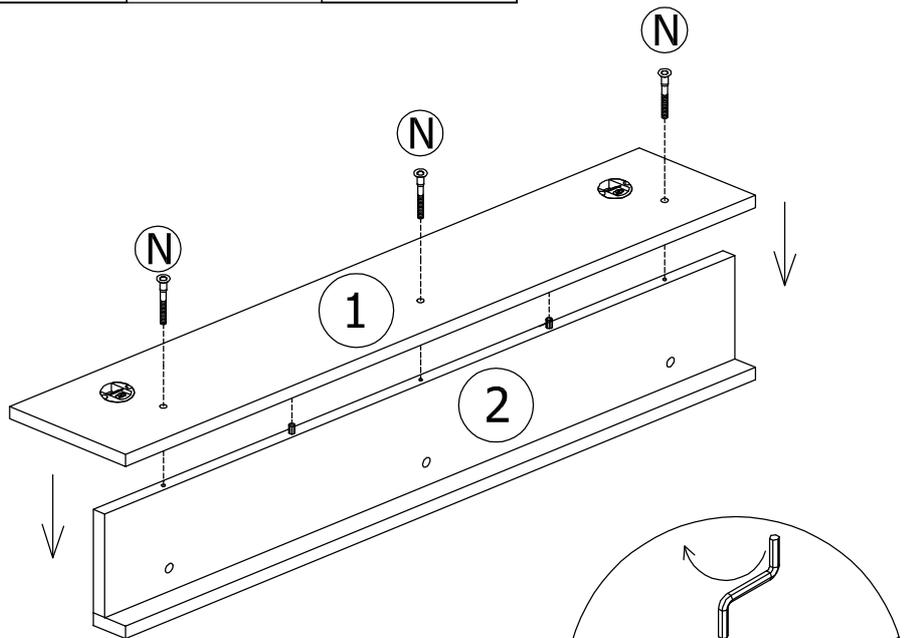

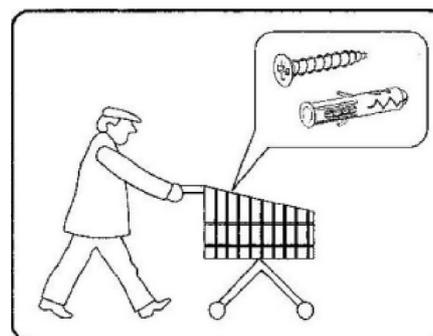
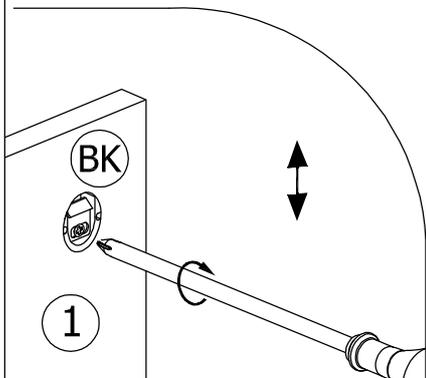
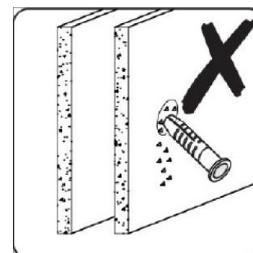
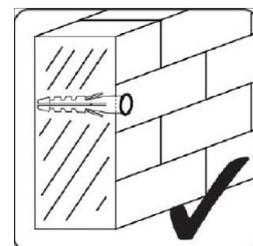
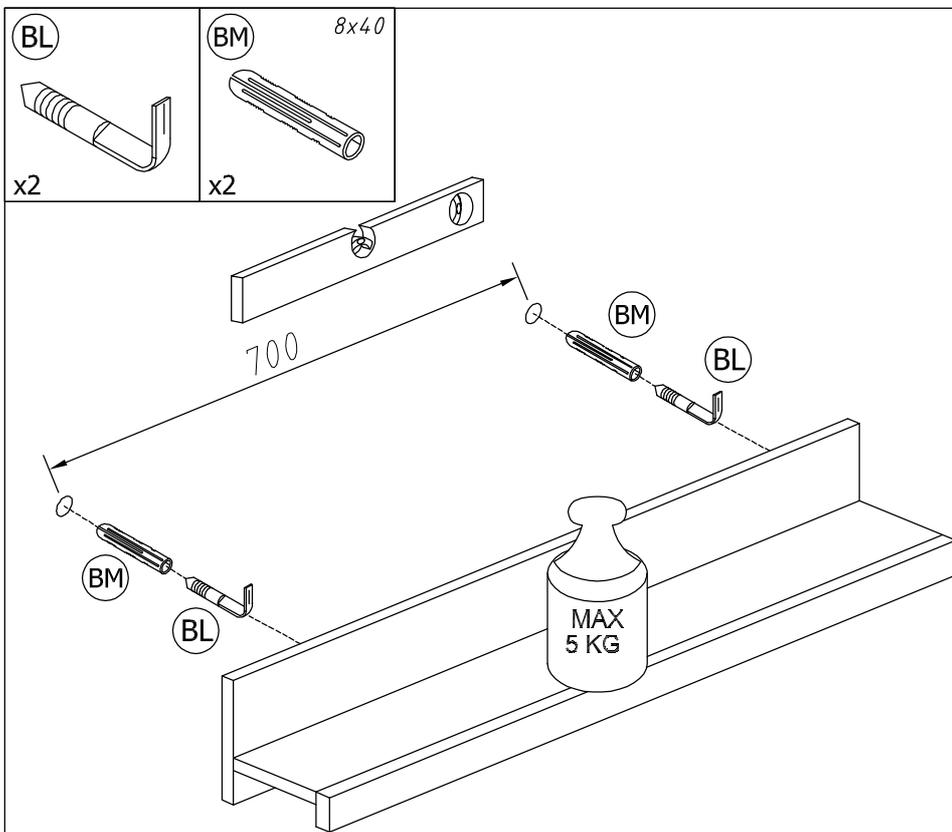

| Uwaga • Achtung • Attention • Caution • Figyele • Attenzione • Opgelet , Atentie • Upozornenie • Dikkat • Upozornini • Внимание | |
|--|--|
| (D) | Die Befestigung des Möbelsstückes an der Wand muss von einer fachkundigen Person vorgenommen werden, da für die Montage an die Wand angepasste Dübel erforderlich sind |
| (GB) | A qualified professional is required when mounting furniture to the wall since dowels corresponding to the wall are required for this |
| (F) | Le montage du meuble au mur peut être fait uniquement par le personnel spécialisé. Il est nécessaire d'utiliser des chevilles bien ajustées pendant le montage au mur. |
| (RO) | Montarea mobilei pe poate fi efectuată numai de către personalul calificat deoarece la această montare se folosește cepuri. |
| (I) | Attaccare un alla parete può essere effettuato esclusivamente dal personale adatto perché durante il montaggio bisogna usare dei cavicchi adatti. |
| (NL) | een vakkundige persoon dient het meubelstuk aan de muur te bevestigen; voor de montage aan de muur zijn immers aangepaste pluugen vereist |
| (PL) | Mocowanie do ściany może przeprowadzić wyłącznie odpowiedni do tego personel, ponieważ w czasie montażu w ścianie konieczne jest zastosowanie dopasowanych kołków |
| (TR) | Möbilya parçasının duvara sabitlenmesi, duvar montajı için özel uyarlanmış dübeller gerektirdiğinden bu iş sadece bu konuda uzman bir kişi tarafından gerçekleştirilmelidir. |
| (CZ) | Připevnění nábytku ke stěně může uskutečnit výhradně k tomu určený personál, protože pro montáž je nutné použít hmoždinky shodné s typem a tloušťkou stěny. |
| (SK) | Pripnenie nábytku k stene môže uskutočniť výhradne k tomu určený personál, pretože k montáži je nutné použiť hmoždinky zhodné s typom steny a jej hrúbkou |
| (HU) | A bútor a falhoz való rögzítését kizárólag erre illetékes személyzet végezheti, mivel a falhoz való rögzítés során megfelelő méretű csapszeg alkalmazása szükséges. |
| (RU) | Очищайте от пыли тряпкой или слегка влажной ветошью. Не допускается применение чистящих средств, не предназначенных для ухода за мебелью. |

