

Ariela

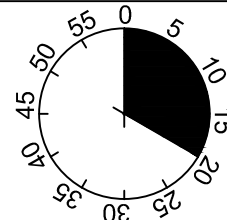

1

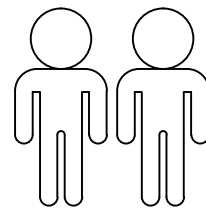
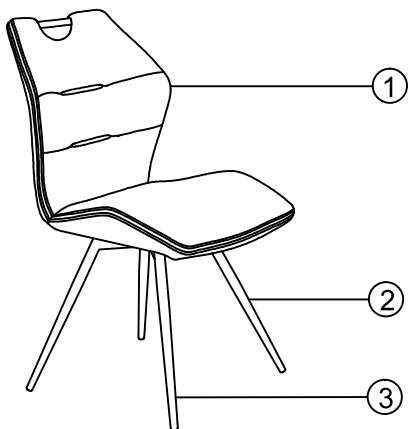
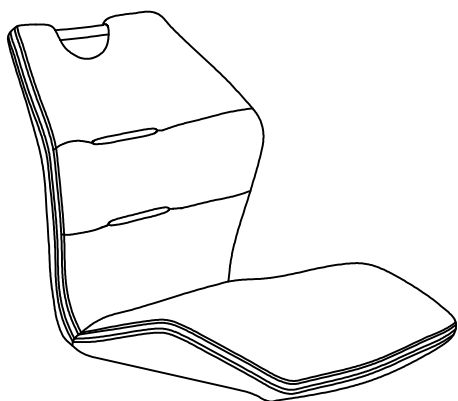

2

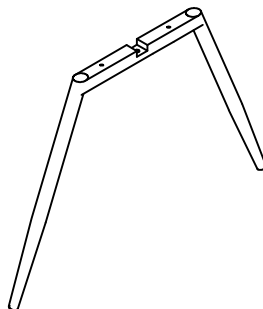

3

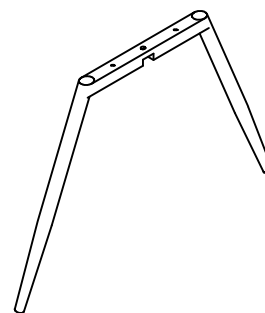

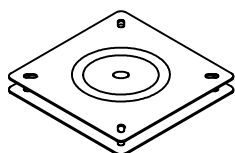

4





| | |
|---|-----|
| 1 | 1 x |
| 2 | 1 x |
| 3 | 1 x |
| 4 | 1 x |

A M6X20

 6x

B M6x25

 1x

C M6x30

 2x

D Ø18xØ6x1.5

 9x

E Ø18xØ8x10

 2x

F 4MM

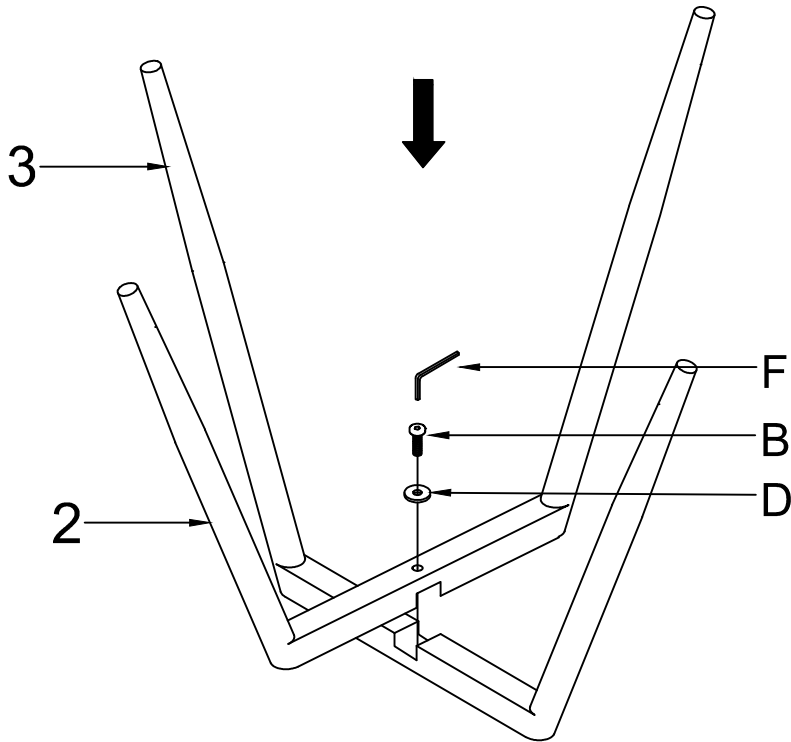
 1x

I.

1

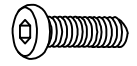

B M6x25



1x

D Ø18xØ6x1.5



1x

F 4MM

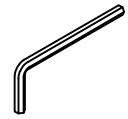

1x



2

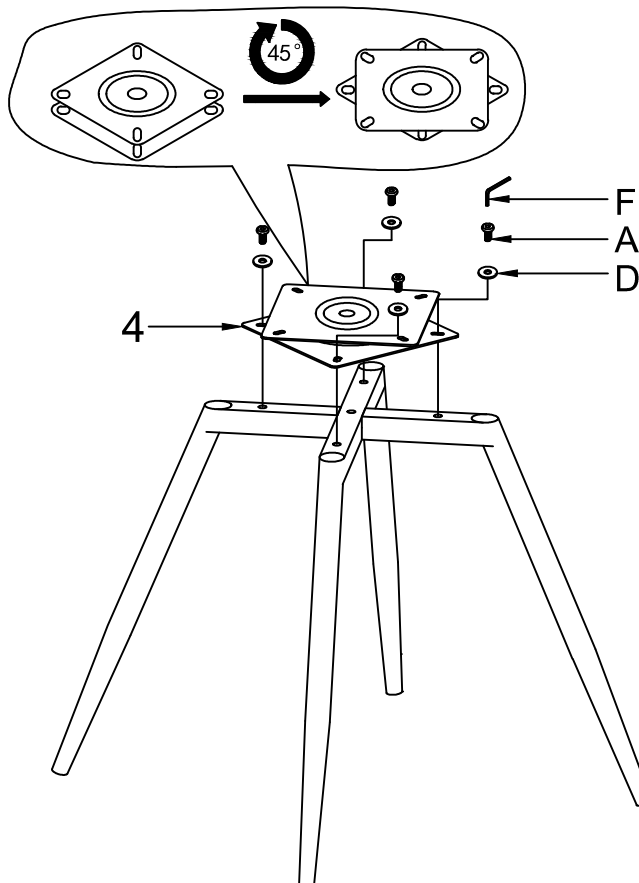

A M6X20

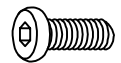

4x

D Ø18xØ6x1.5



4x

F 4MM

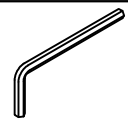







1x

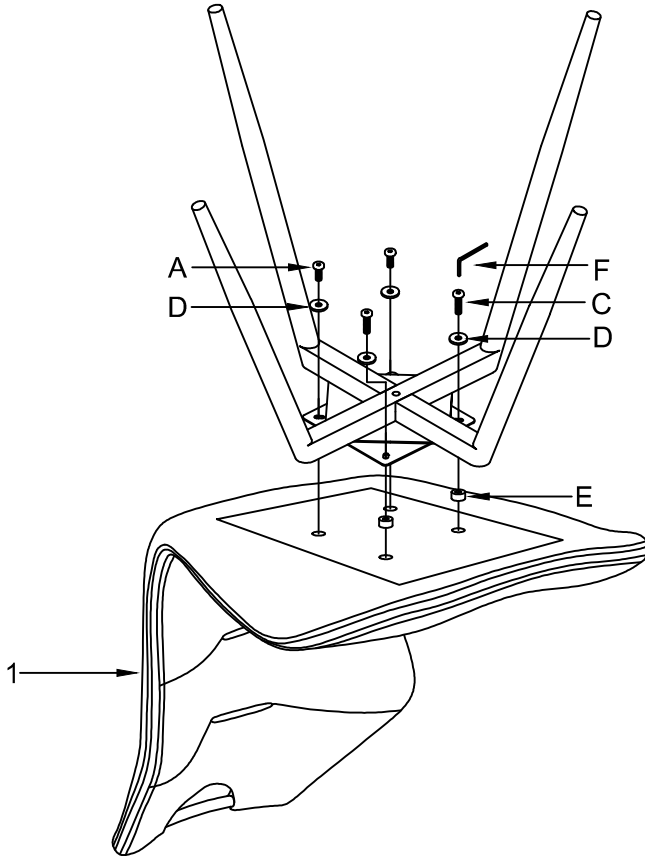

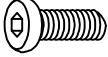
II.



3

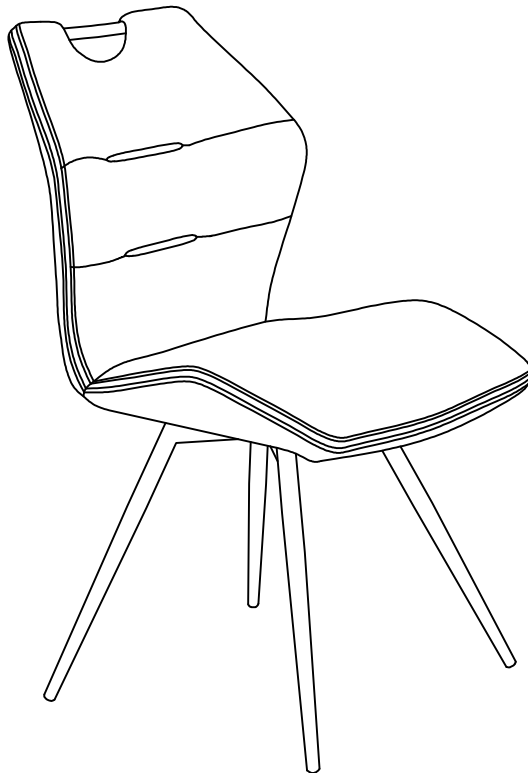

| | | |
|-------------------------------------------------------------------------------------|------------|-------------------------------------------------------------------------------------|
| A | M6X20 |  |
| | 2x | |
| C | M6X30 |  |
| | 2x | |
| D | Ø18xØ6x1.5 |  |
| | 4x | |
| E | Ø18xØ8x10 |  |
| | 2x | |
| F | 4MM |  |
| | 1x | |
|  | | |

4

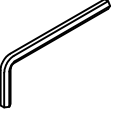

| | | |
|---------------------------------------------------------------------------------------|-----|---------------------------------------------------------------------------------------|
| F | 4MM |  |
| | 1x | |
|  | | |

