

# SILIAS T05

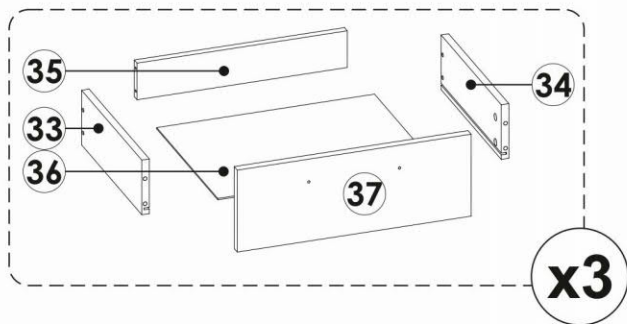

# SILIAS T05

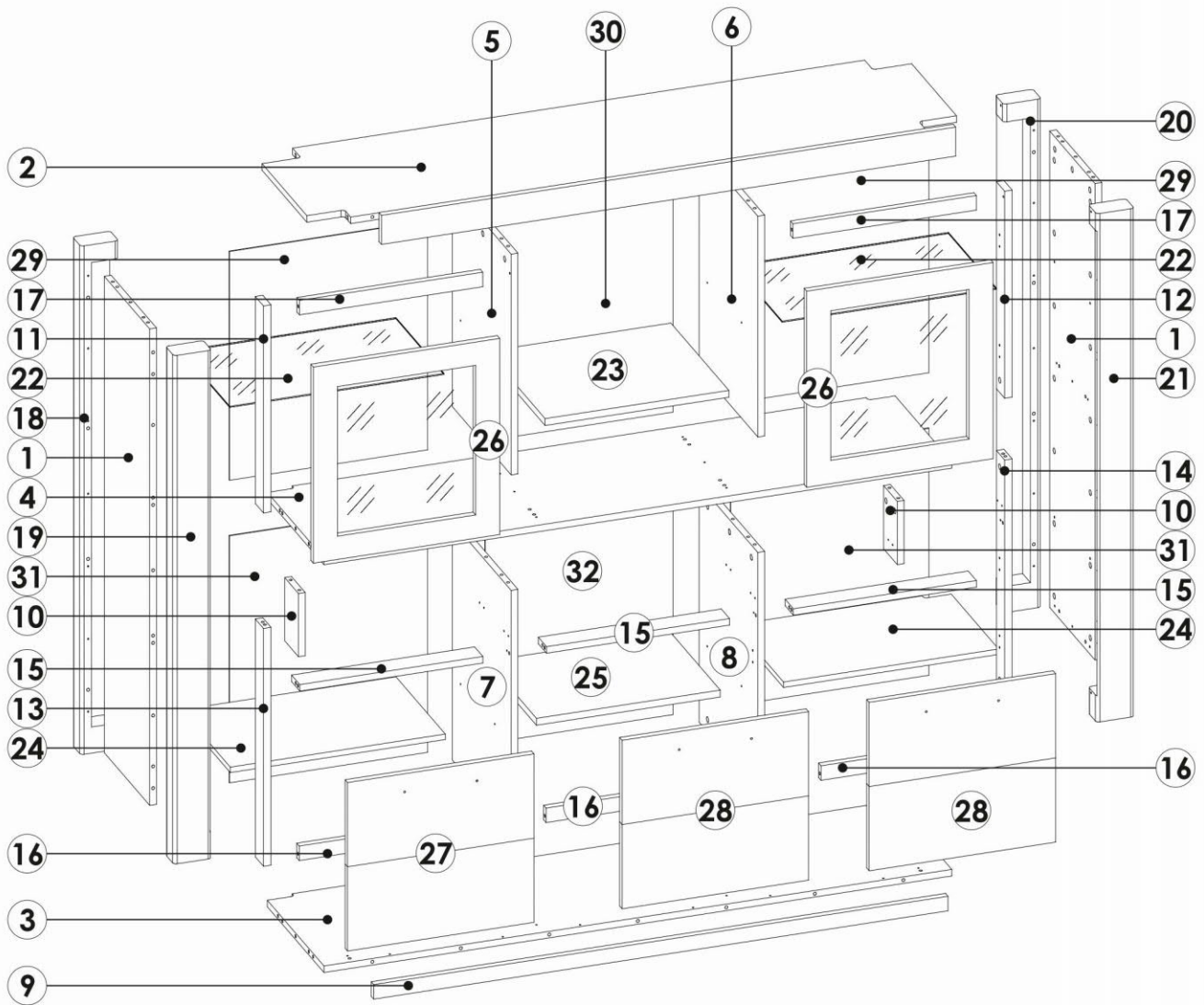











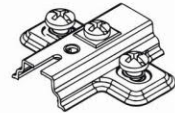
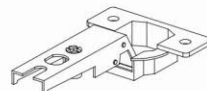



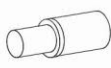

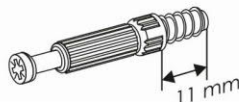

---

①	1312	330	19	x2	1/4
②	1725	450	80	x1	2/4
③	1667	428	19	x1	2/4
④	1667	428	19	x1	2/4
⑤	608	428	19	x1	4/4
⑥	608	428	19	x1	4/4
⑦	655	428	19	x1	4/4
⑧	655	428	19	x1	4/4
⑨	1525	40	18	x1	2/4
⑩	175	10	19	x2	4/4
⑪	570	61	20	x1	4/4
⑫	570	61	20	x1	4/4

⑬	655	60	20	x1	4/4
⑭	655	60	20	x1	4/4
⑮	486	60	19	x3	4/4
⑯	486	40	19	x3	4/4
⑰	486	45	19	x2	3/4
⑱	1400	100	60	x1	1/4
⑲	1400	100	60	x1	1/4
⑳	1400	100	60	x1	1/4
㉑	1400	100	60	x1	1/4
㉒	569	352	6	x2	2/4
㉓	488	423	19	x1	4/4
㉔	570	360	19	x2	2/4

⑳	485	360	19	x1	4/4
㉑	540	495	22	x2	3/4
㉒	495	450	48	x1	3/4
㉓	495	450	48	x2	3/4
㉔	630	526	3	x2	3/4
㉕	630	504	3	x1	3/4
㉖	683	527	3	x2	3/4
㉗	683	504	3	x1	3/4
㉘	350	100	16	x3	3/4
㉙	350	100	16	x3	3/4
㉚	446	80	16	x3	3/4
㉛	460	358	3	x3	2/4
㉜	495	180	18	x3	3/4

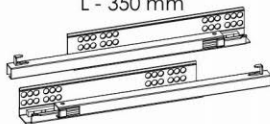
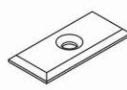
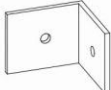
# SILIAS T05

<b>A1</b> 8 x 30 mm x40 	<b>A2</b> 8 x 50 mm x8 	<b>B0</b>  x10
<b>B1</b>  x10	<b>C1</b> 5 x 9 mm x16 	<b>C2</b> 5 x 13 mm x48 
<b>D1</b>  x16	<b>D2</b>  x8	<b>E1</b> 15 x 12 mm x113 
<b>F1</b> 6 x 34 mm x101  11 mm	<b>F2</b> 6 x 34 mm x12  8 mm	<b>G1</b> 6,4 x 50 mm x16 
<b>H1</b> L - 260 mm x6 	<b>I1</b> 3 x 16 mm x110 	<b>M4</b> M4 x 22 mm x12 
<b>N2</b> 3 x 16 mm x6 	<b>N8</b> 4 x 16 mm x8 	<b>N14</b> 4 x 30 mm x4 
<b>N15</b> 4 x 35 mm x6 	<b>NG</b>  x1	<b>PD</b> L - 350 mm x3 
<b>R0</b>  x40	<b>W1</b>  x12	<b>S</b>  x113