

WF306823AAW/WF306824AAW

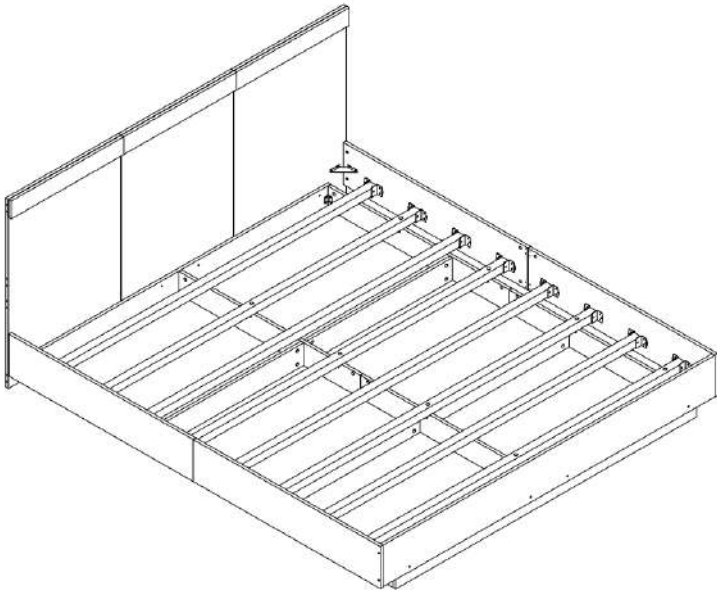

Please check that you have all the parts listed before you start assembling, if you do find that something is missing, do not continue assembly, please contact us immediately.

Note: Please do not fully tighten all the screws until the overall frame is built

Bitte überprüfen Sie, ob alle Teile mitgeliefert sind, bevor Sie mit der Montage beginnen. Wenn Sie festlegen, dass etwas fehlt, setzen Sie die Montage nicht fort. Bitte kontaktieren Sie uns sofort.

Achtung : Bitte ziehen Sie nicht alle Schrauben fest, bevor die Montage abgeschlossen ist !

D Gebrauchsanweisung

NL Gebruiksrichtlijnen

IT Istruzioni per l'uso

CZ Pokyny k použití

HU Használati útmutató

PT Instruções de utilização

SK Pokyny k použitiu

GB Instructions for use

FR Instructions d'utilisation

PL Instrukcja obsługi

ES Instrucciones de empleo

RO Instrucțiuni de folosire

RU Инструкция по монтажу

TR Kullanım talimatları

This set will be shipped by 2 boxes and they may arrive on different days. If both packages arrived but parts missing, please contact customer service.

Dieses Set ist in 2 Boxen enthalten. Wenn Sie keine vollen 2 Boxen erhalten, wenden Sie sich bitte an unseren Kundenservice

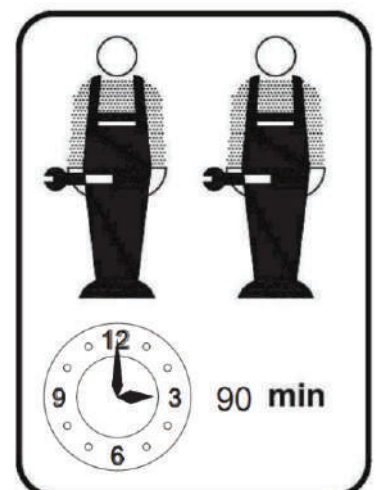

**FR - Notice de montage / EN - Assembly instructions / PT - Instruções de montagem /
ES - Prospecto de montaje / DE - Montageanleitung / IT - Istruzioni di montaggio /
NL - Montagehandleiding**

FR - IMPORTANT! CONSERVER POUR CONSULTATION ULTERIEURE: LIRE ATTENTIVEMENT

- A monter par un adulte. Un adulte doit vérifier le bon assemblage avant l'emploi
- ATTENTION! tenir les vis et petits éléments et sachets hors de portée des enfants
- Bien identifier les éléments avant de commencer le montage
- Ne pas utiliser votre article lorsque l'un de ses éléments est cassé ou manquant
- En cas de problème contactez notre service après-vente
- Toujours suivre les instructions du fabricant
- Entretien: nettoyer avec un chiffon doux et sec. En cas de taches plus grosses, frottez soigneusement avec une éponge légèrement humide et non abrasive
- Ne pas sauter sur le lit

EN - IMPORTANT! KEEP FOR FUTURE REFERENCE: READ CAREFULLY

- To be assembled by an adult. Assembly must be checked by an adult before use
- WARNING! keep all screws, small parts and plastic bags out of the reach of children
- Properly identify all parts before assembling
- Never use your item if any of its parts are broken or missing
- Should any problems arise, please contact our After Sales Service
- Manufacturer's instructions shall be followed at all times
- Care: clean with a soft, dry cloth. In case of larger stains, carefully rub with a slightly damp, non-abrasive sponge
- Do not jump on the bed

PT - IMPORTANTE! GARDE PARA CONSULTA POSTERIOR: LER ESTAS INSTRUÇÕES CUIDADOSAMENTE

- A ser montado por um adulto. Um adulto deve verificar a boa montagem antes da utilização
- Atenção! mantenha os parafusos, acessórios pequenos e saco de plástico fora do alcance das crianças
- Identifique bem os acessórios antes de começar a montagem
- Não utilizar o artigo se um dos elementos está em falta ou danificado
- Para qualquer esclarecimento, contacte os nossos serviços através do telefone
- As instruções do fabricante devem ser sempre cumpridas
- Manutenção: limpe com um pano macio e seco. Em caso de manchas maiores, esfregue cuidadosamente com uma esponja ligeiramente húmida e não abrasiva
- Não salte na cama

ES - IMPORTANTE! CONSERVAR PARA FUTURAS CONSULTAS: LEER DETENIDAMENTE

- A montar por un adulto. Un adulto debe comprobar el buen montaje antes de la utilización
- ¡ADVERTENCIA! mantener los tornillos, los pequeños elementos y bolsitas fuera del alcance de los niños
- Identificar debidamente los elementos antes de empezar el montaje
- No utilizar este artículo si uno de los elementos falta o esta roto
- Si tiene problemas, contactar nuestro servicio postventa
- Deben seguirse siempre las instrucciones del fabricante Cuidados: limpiar con un paño suave y seco. En caso de manchas grandes, frotar con cuidado utilizando una esponja húmeda no abrasiva
- No saltar sobre la cama

DE - WICHTIG! FÜR SPÄTERE BEZUGNAHME AUFBEWAHREN: SORGFÄLTIG LESEN

- Von einem Erwachsenen zu montieren. Die korrekte Montage muss vor Gebrauch von einem Erwachsenen geprüft werden
- Achtung! die Schrauben und kleinen Teile ausserhalb der Reichweite von Kindern lagern
- Vor Montagebeginn alle Teile identifizieren
- Ihren Artikel nicht benutzen, wenn eines seiner Bestandteile beschädigt ist oder fehlt
- Im Problemfall Ihren Kundendienst anrufen
- Stets die Herstelleranweisungen beachten
- Wartung: Mit einem weichen, trockenen Tuch reinigen. Bei größeren Flecken vorsichtig mit einem leicht feuchten, nicht scheuernden Schwamm abreiben
- Nicht auf dem Bett springen

IT - IMPORTANTE! CONSERVARE QUESTE INFORMAZIONI PER ULTERIORI CONSULTAZIONI: LEGGI ATTENTAMENTE

- Il montaggio deve essere eseguito da un adulto. Un adulto dovrà verificare il corretto montaggio prima dell'uso
- ATTENZIONE! tenere le viti ed i componenti di piccole dimensioni lontano dalla portata dei bambini
- Controllare i pezzi prima del montaggio
- L'articolo non deve essere utilizzato in caso di elementi mancanti o danneggiati
- In caso di necessità contattare il nostro servizio post-vendita
- Seguire sempre le istruzioni del costruttore
- Manutenzione: pulire con un panno morbido e asciutto. Per le macchine più grandi, strofinare accuratamente con una spugna leggermente umida e non abrasiva
- Non saltare sul letto

NL - BELANGRIJK! BEWAAR VOOR LATERE RAADPLEGING: LEES AANDACHTIG

- Moet door een volwassene worden gemonteerd. Voor gebruik moet een volwassene controleren dat het product goed in elkaar is gezet
- WAARSCHUWING! schroeven en kleine elementen en zakjes buiten bereik van kinderen houden
- De elementen goed identificeren alvorens met de montage te beginnen
- Uw artikel niet gebruiken wanneer een van de onderdelen kapot is of ontbreekt
- Neem bij problemen contact op met onze klantenservice
- Volg altijd de instructies van de fabrikant
- Onderhoud: maak schoon met een zachte en droge doek. In geval van grotere vlekken, veeg voorzichtig schoon met een licht bevochtigde en niet-schurende spons
- Niet springen op het bed

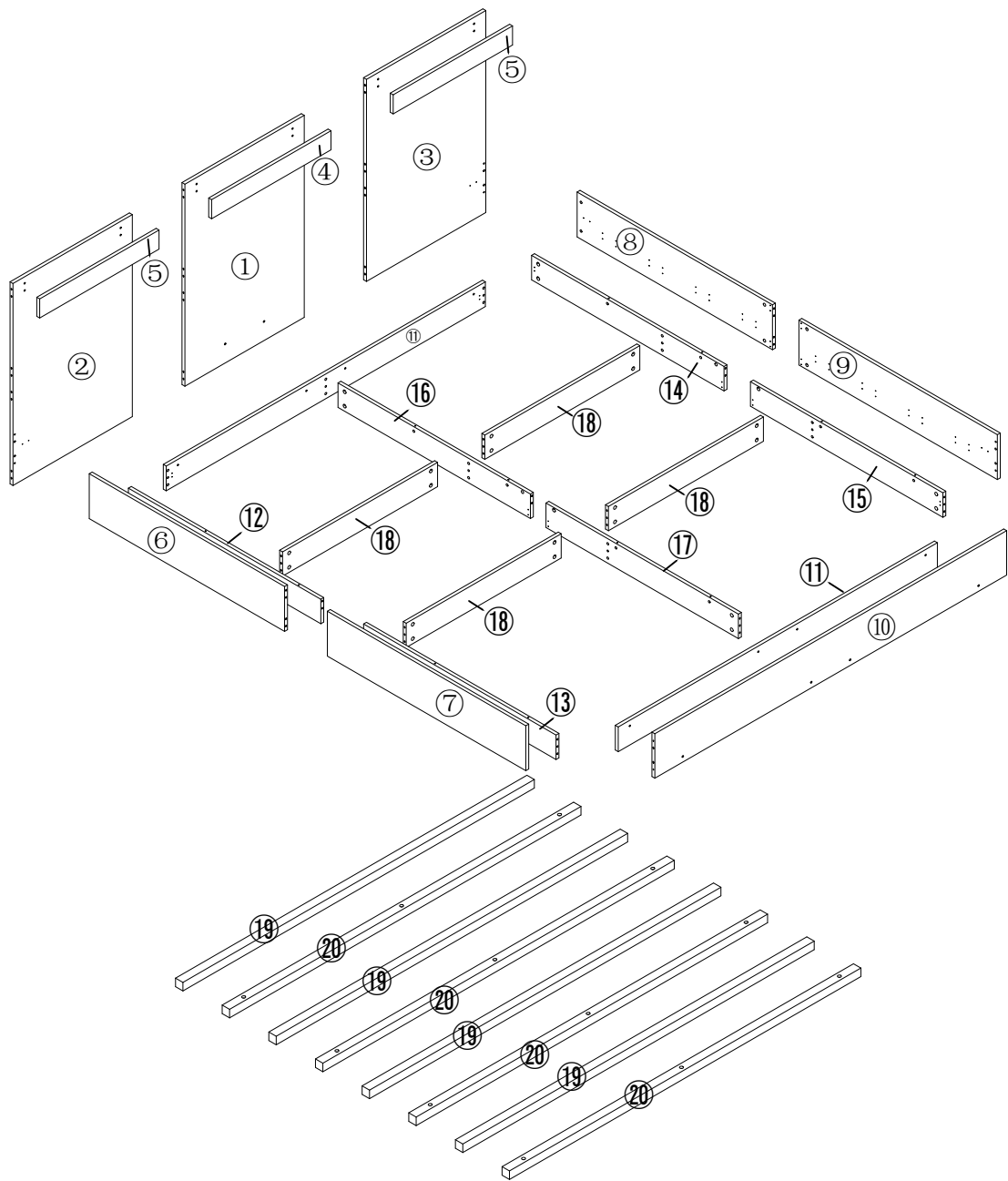

WF306823AAW

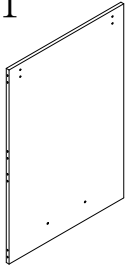
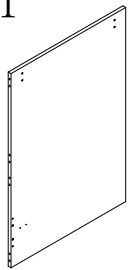
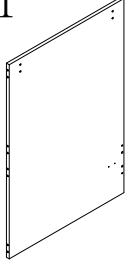
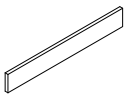
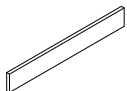
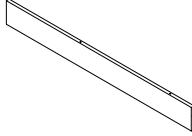
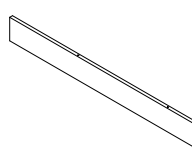
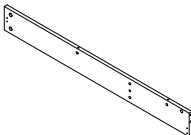
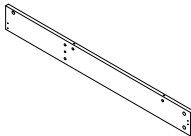
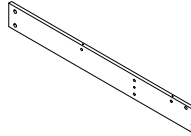
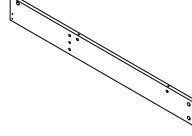
①X1 	②X1 	③X1 	④X1 
⑤X2 	⑫X1 	⑬X1 	⑭X1 
⑮X1 	⑯X1 	⑰X1 	

WF306824AAW

⑥X1

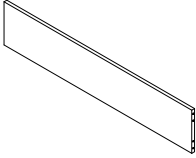

⑦X1

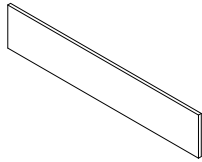

⑧X1

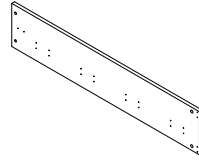

⑨X1

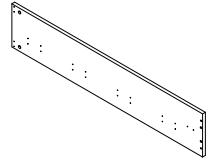

⑩X1

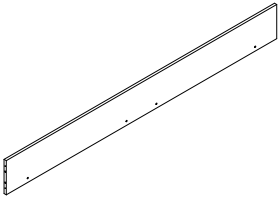

⑪X2

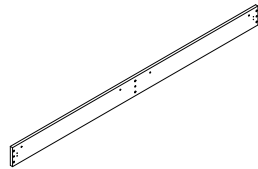

⑱X4

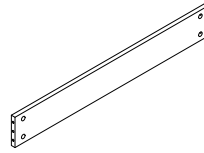



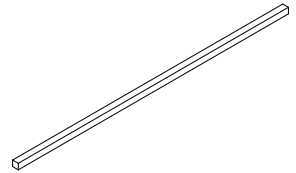

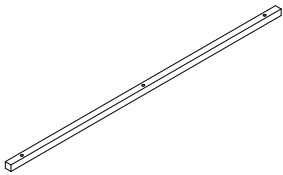

⑲X4

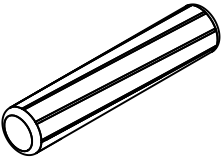
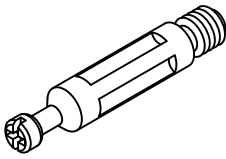

⑳X4

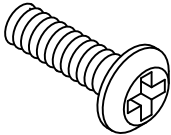
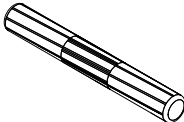
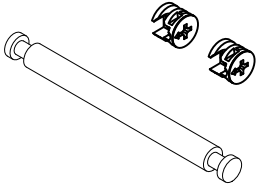
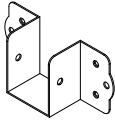

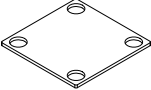

<p>A</p>  <p>$\Phi 8 \times 40 \text{MM}$ 18 pcs</p>	<p>B1</p>  <p>$\Phi 6 \times 40 \text{MM}$ 28 pcs</p>	<p>B2</p>  <p>$\Phi 15 \times 10 \text{MM}$ 28 pcs</p>
<p>C</p>  <p>$\Phi 3.5 \times 14 \text{MM}$ 148 pcs</p>	<p>D</p>  <p>$\Phi 5 \times 50 \text{MM}$ 20 pcs</p>	<p>E</p>  <p>$\Phi 10 \times 10 \text{MM}$ 20 pcs</p>
<p>F</p>  <p>$\Phi 6 \times 25 \text{MM}$ 20 pcs</p>	<p>G</p>  <p>$\Phi 8 \times 60 \text{MM}$ 17 pcs</p>	<p>H</p>  <p>$\Phi 10 \times 10 \text{MM}$ 15 sets</p>
<p>J</p>  <p>16 pcs</p>	<p>K</p>  <p>4 pcs</p>	<p>L</p>  <p>4 pcs</p>
<p>R</p>  <p>13 pcs</p>		

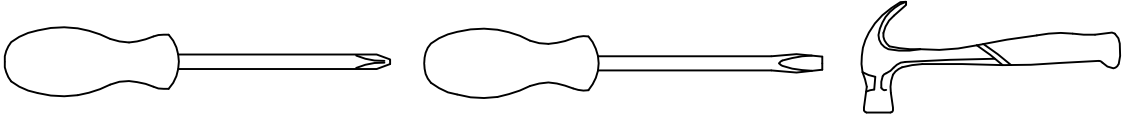
Tools Required (Not Included)



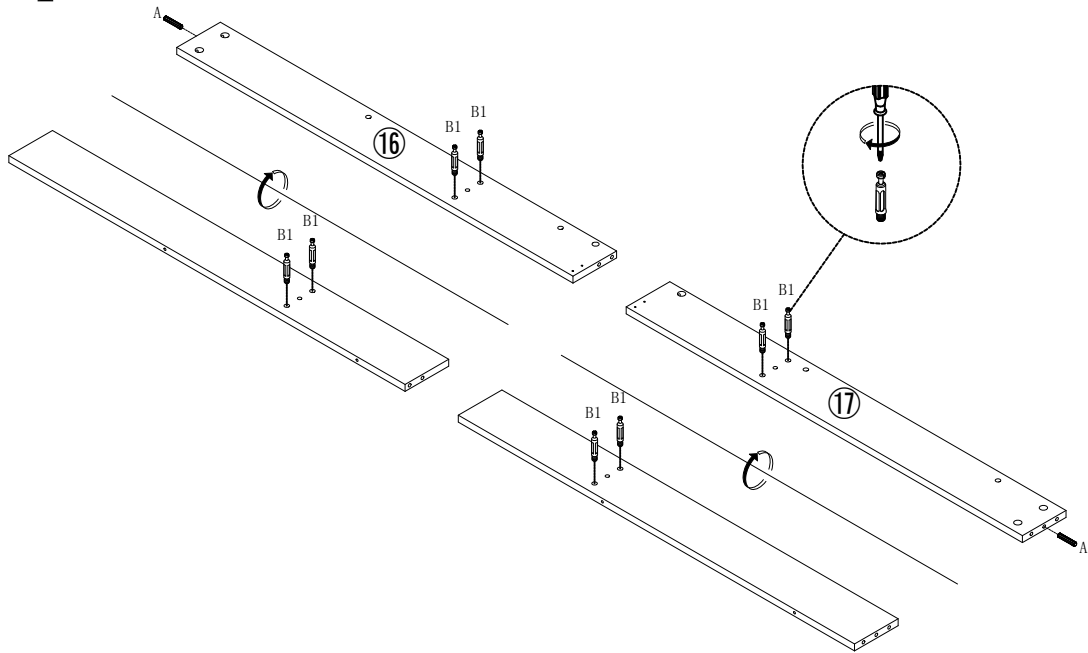

STEP 1

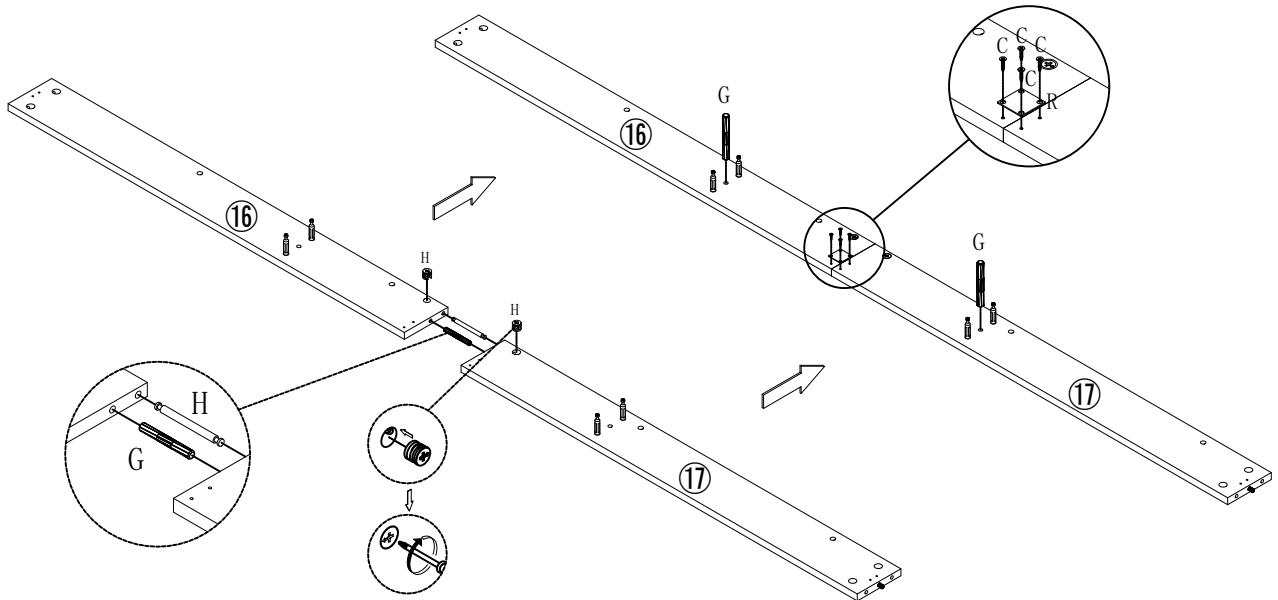

	Ax2pcs		B1x8pcs
---	--------	---	---------

STEP 2



	Cx4pcs		Gx3pcs		Hx1set		Rx1pc
---	--------	---	--------	---	--------	---	-------

STEP 3

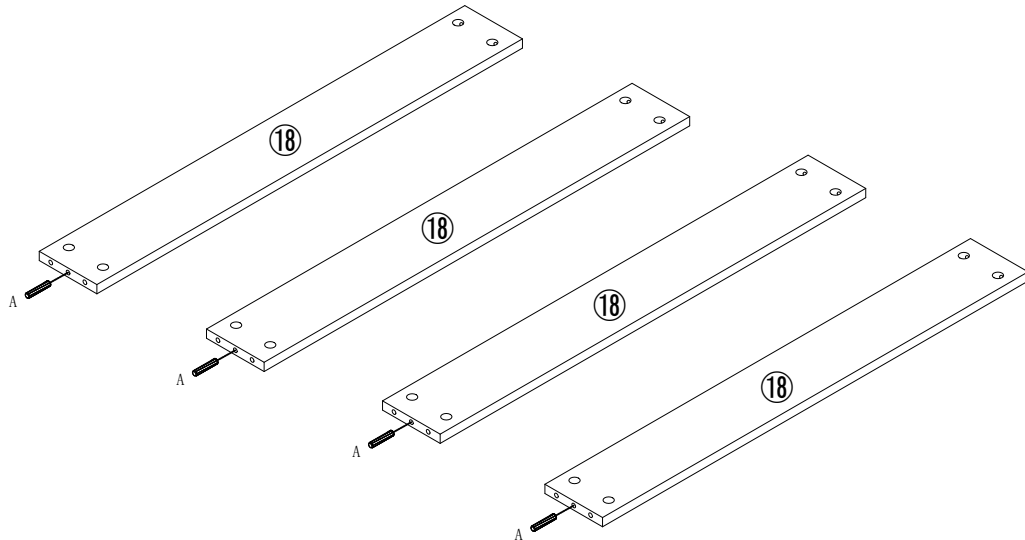

Ax4pcs

STEP 4

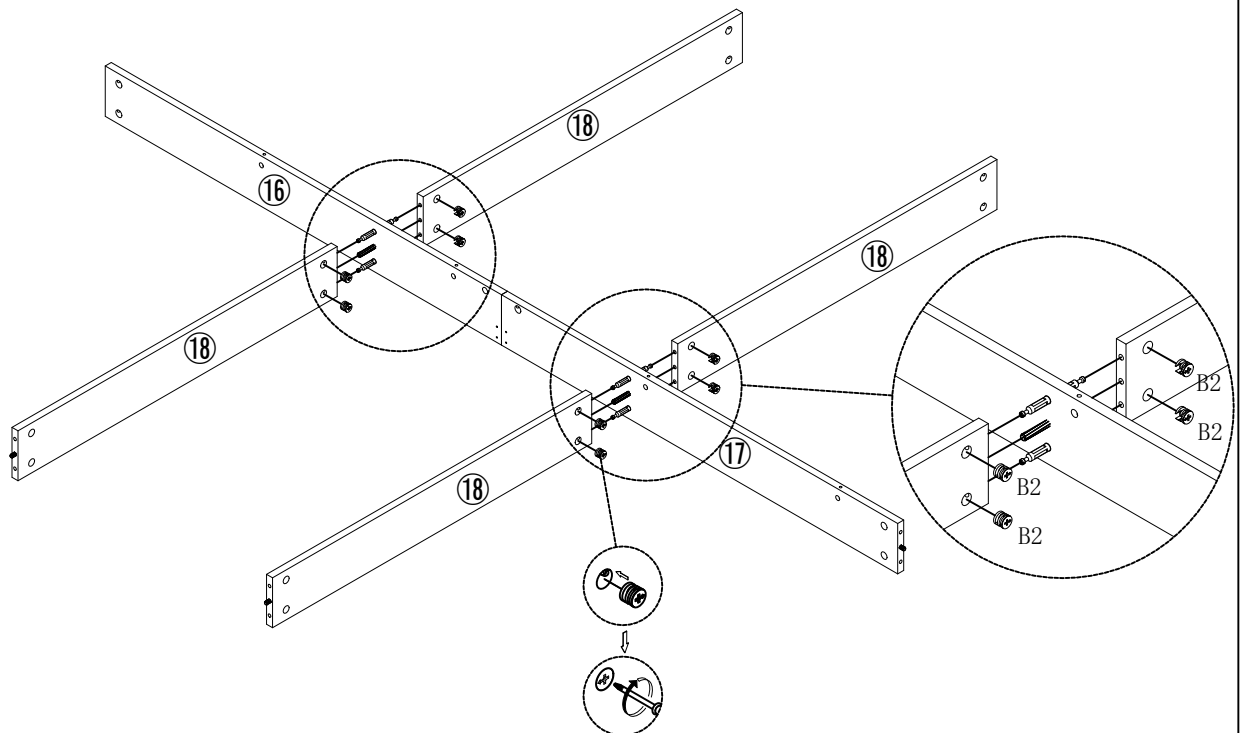

B2x8pcs

STEP 5

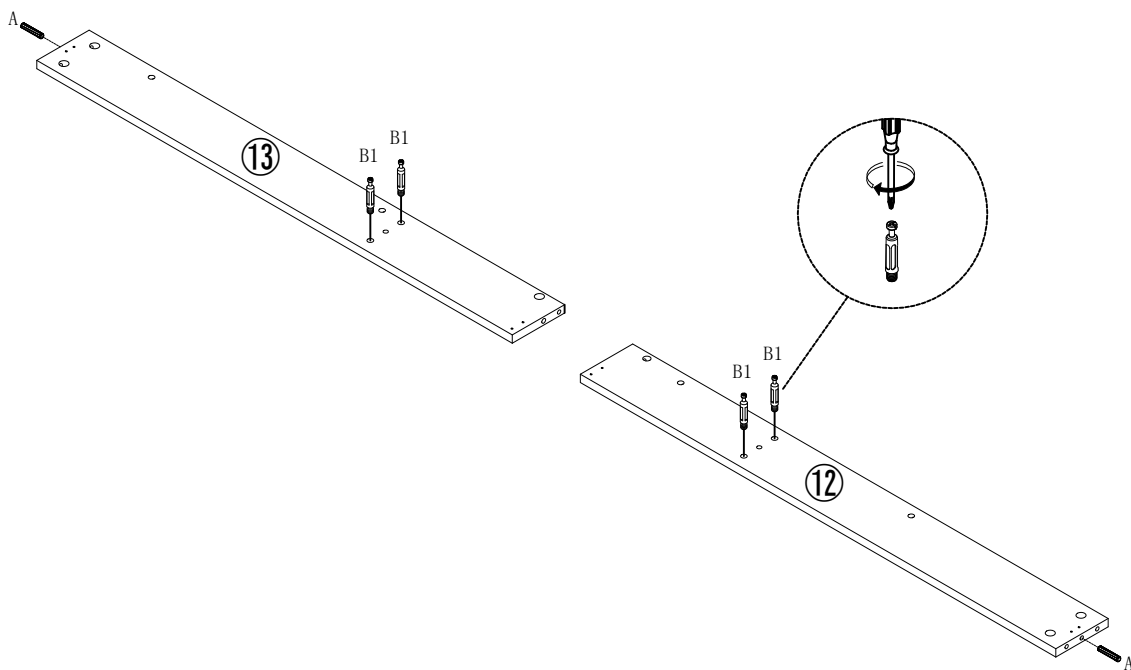

Ax2pcs



B1x4pcs

STEP 6

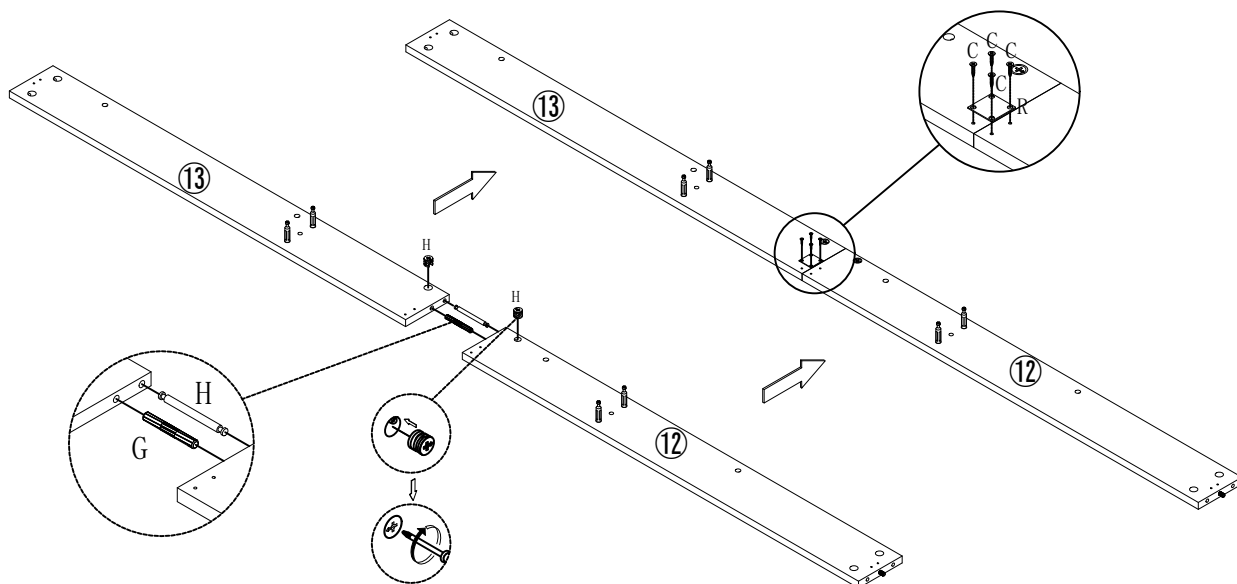

Cx4pcs



Hx1set





Rx1pc



Gx1pc

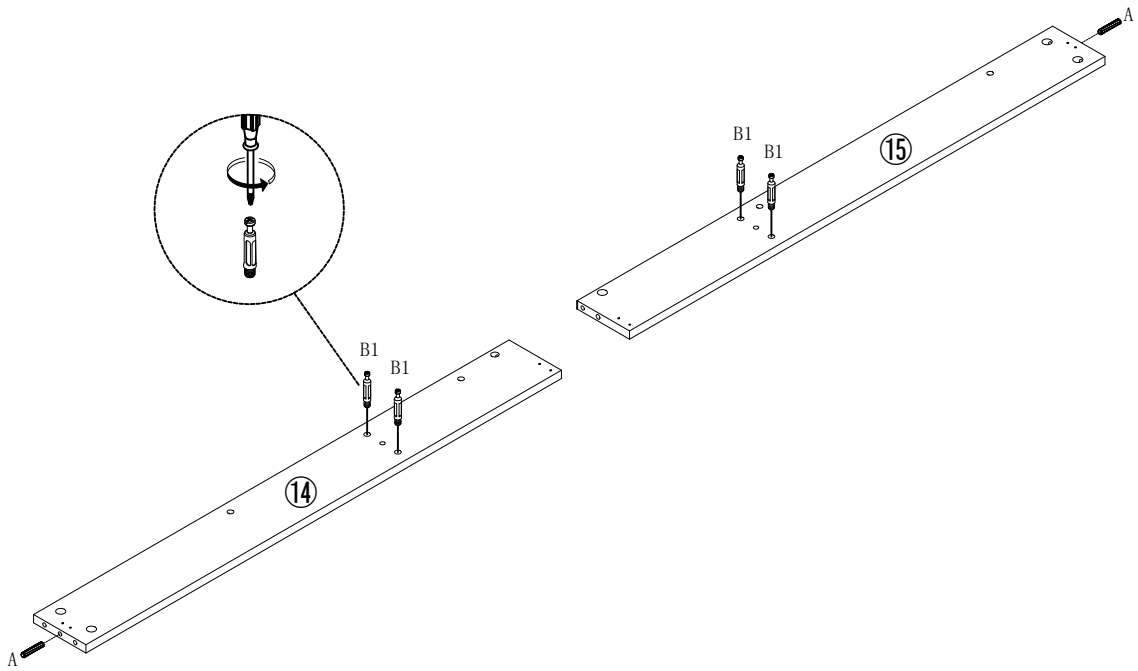



STEP 7

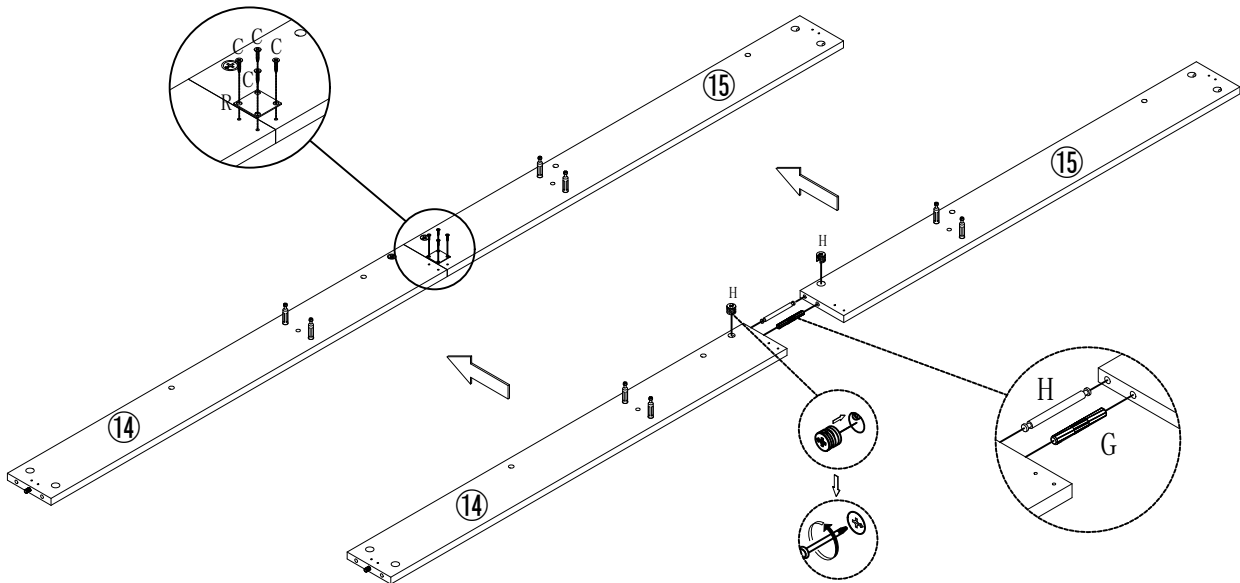

	Ax2pcs		B1x4pcs
---	--------	---	---------

STEP 8



	Cx4pcs		Hx1set		Rx1pc		Gx1pc
---	--------	---	--------	---	-------	---	-------

STEP 9

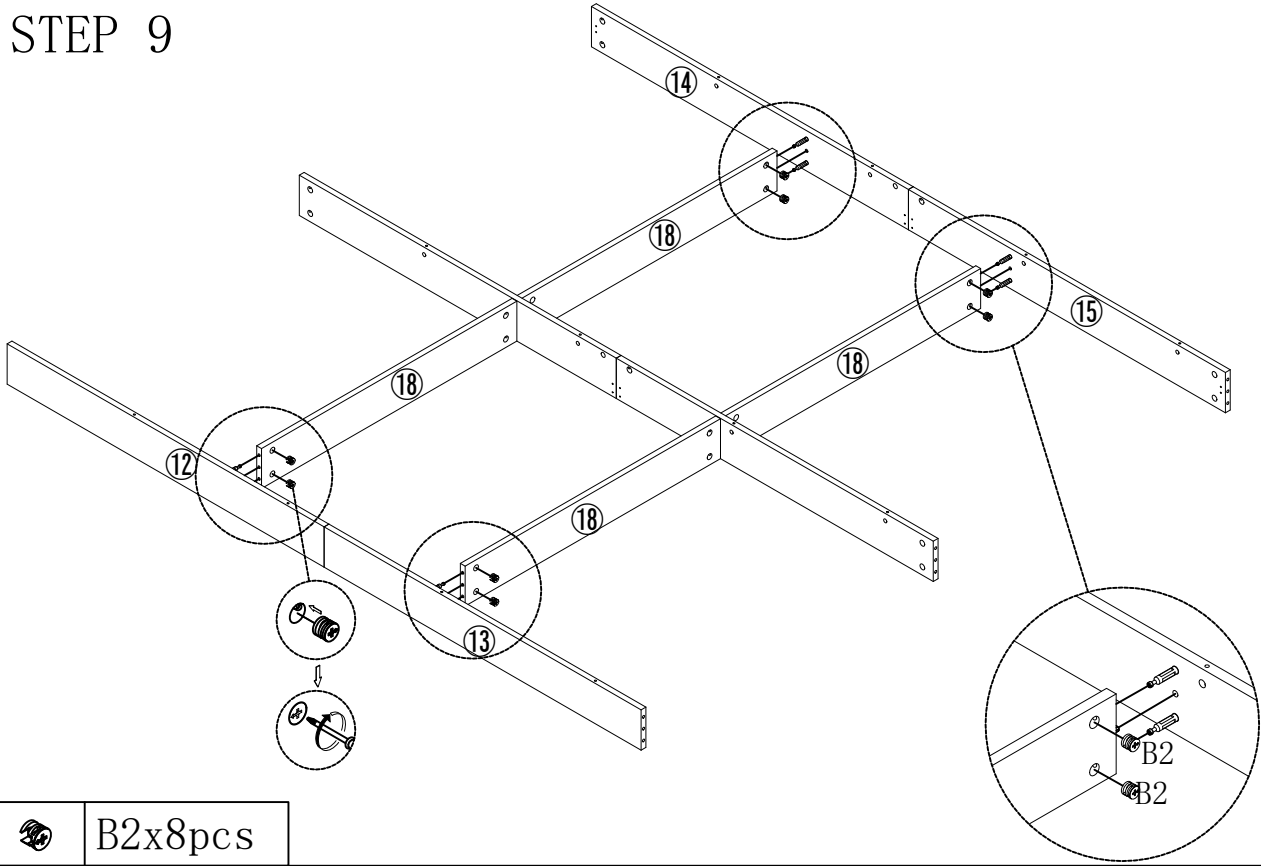

B2x8pcs

STEP 10

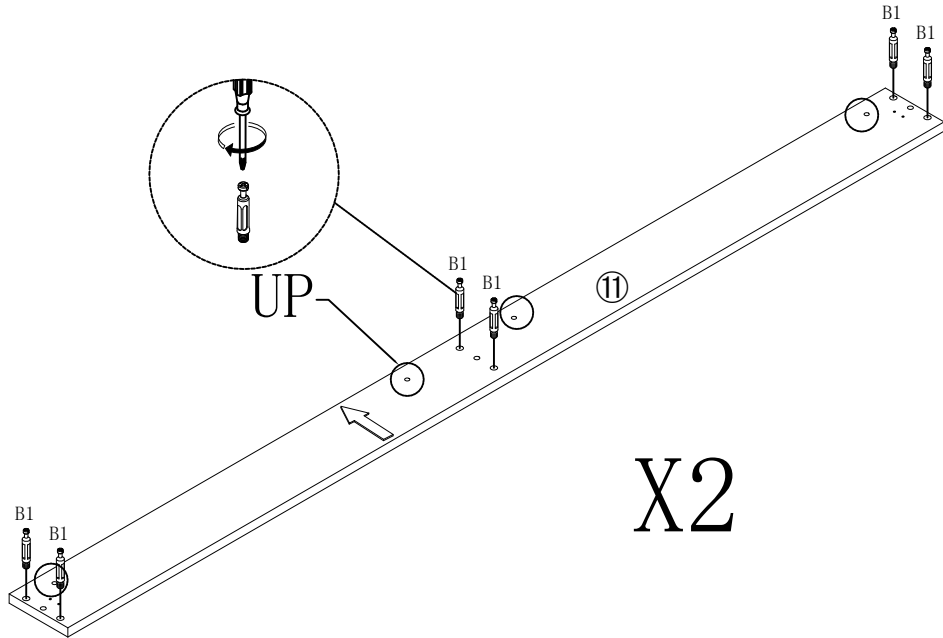

B1x12pcs

STEP 11

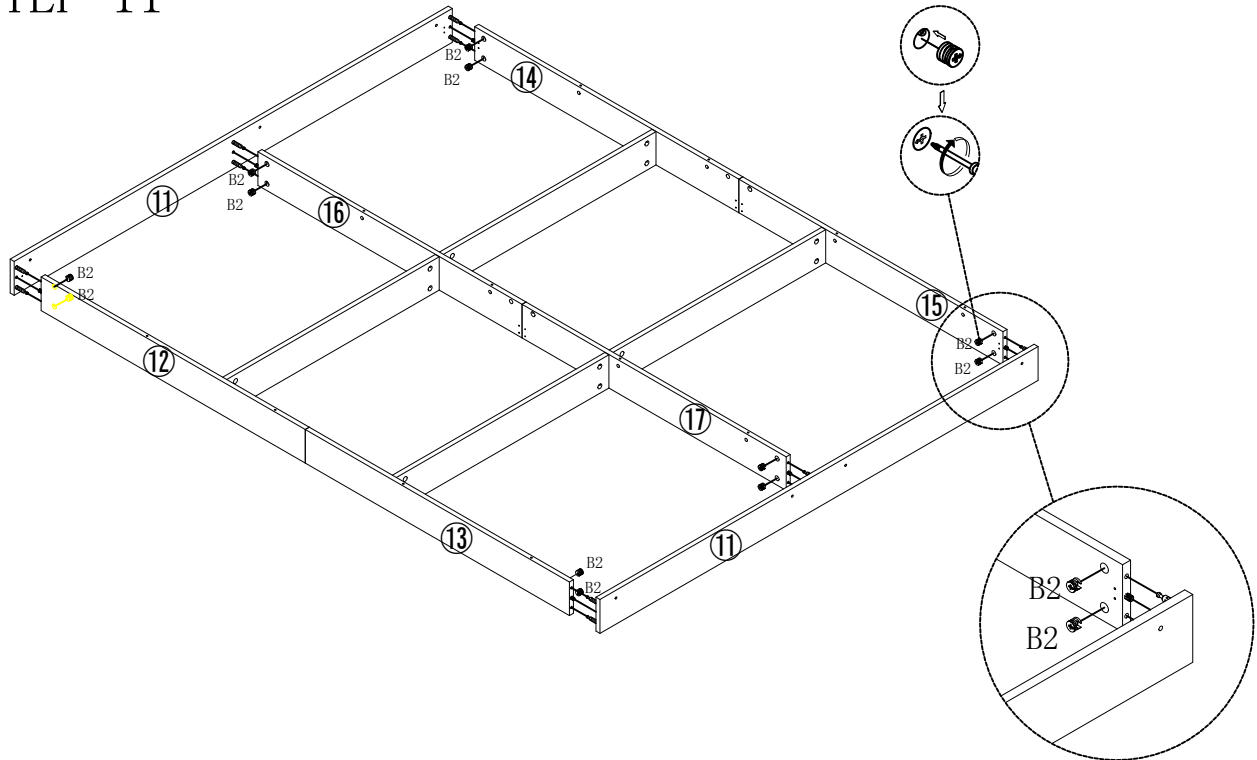

B2x12pcs

STEP 12

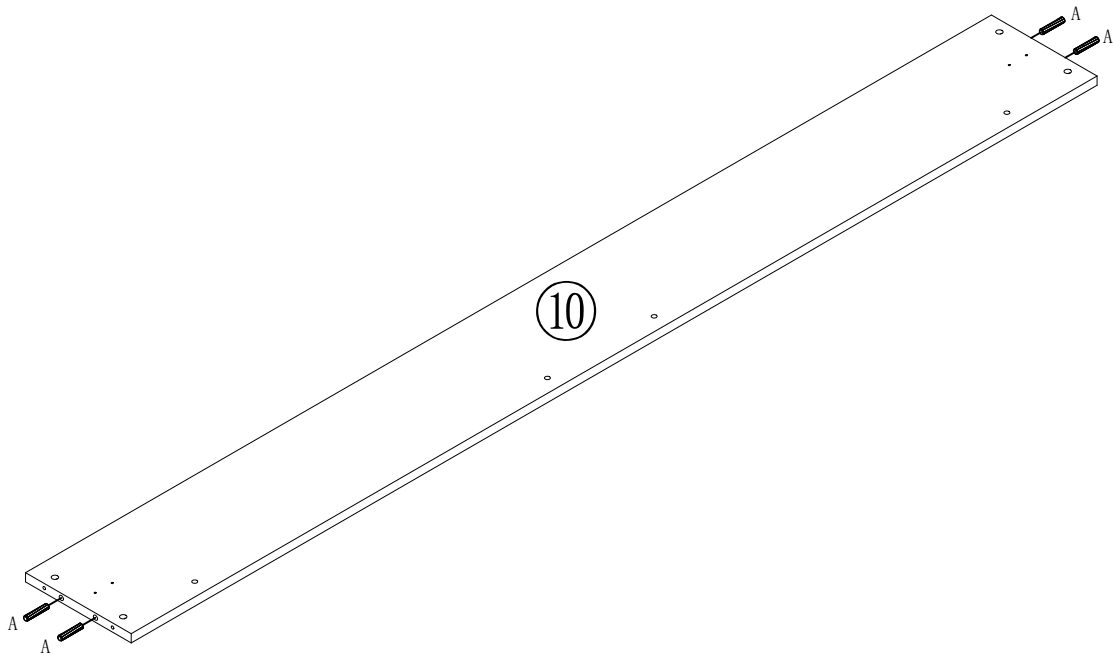

Ax4pcs

STEP 13

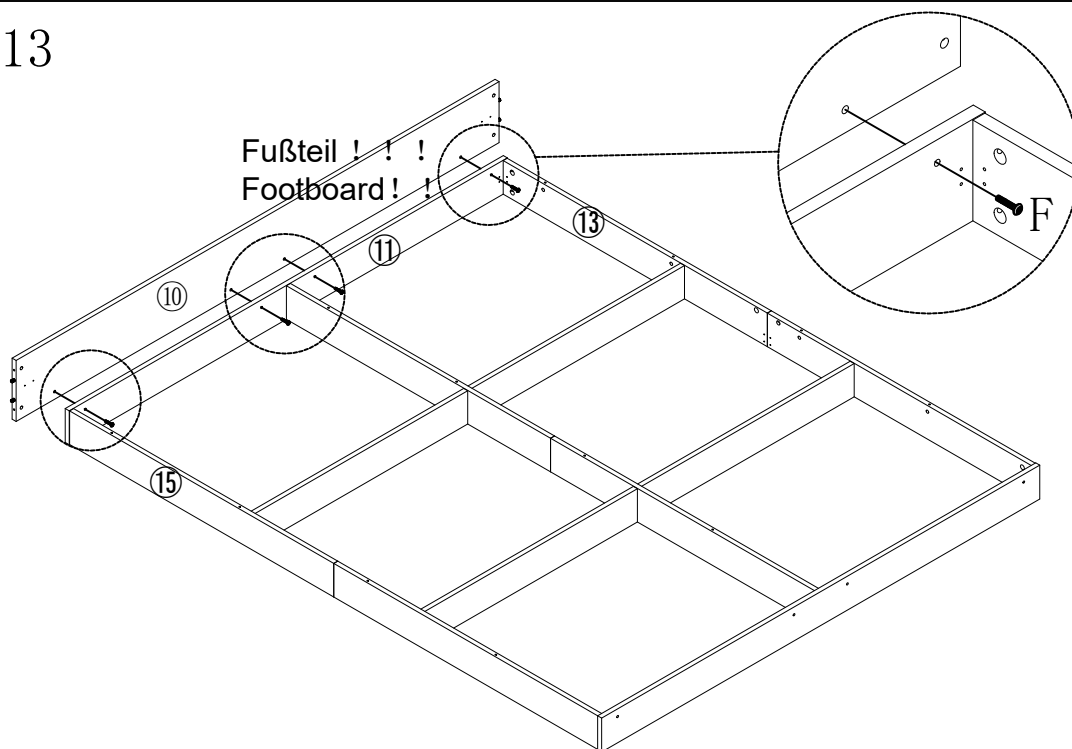

Fx4pcs

STEP 14

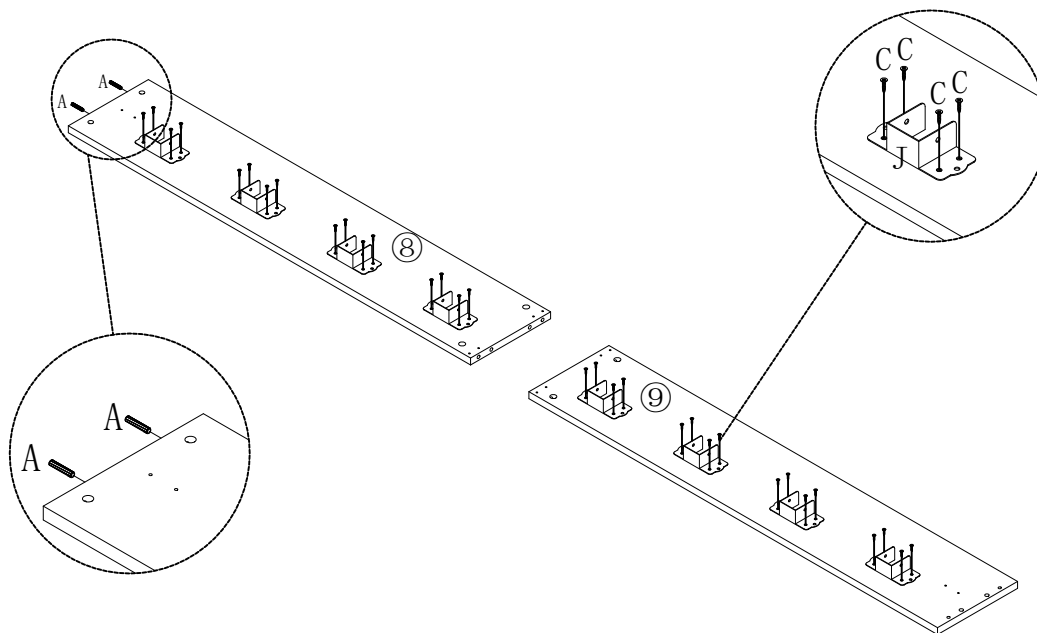

Cx32pcs







Jx8pcs

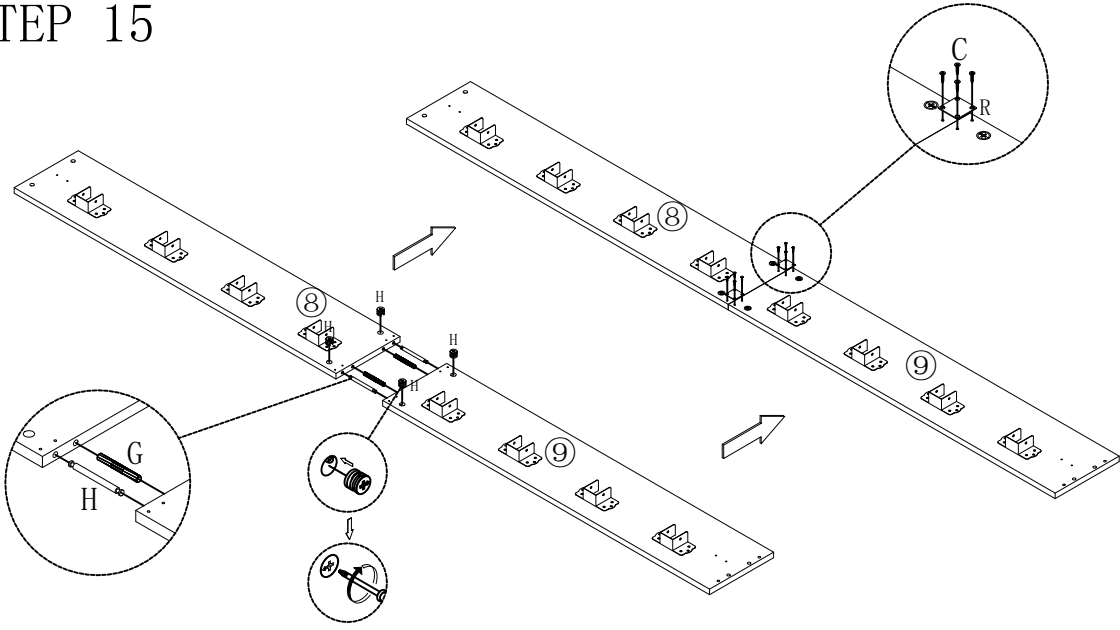

Ax2pcs



STEP 15



	Cx8pcs		Hx2sets		Rx2pcs		Gx2pcs
---	--------	---	---------	---	--------	---	--------

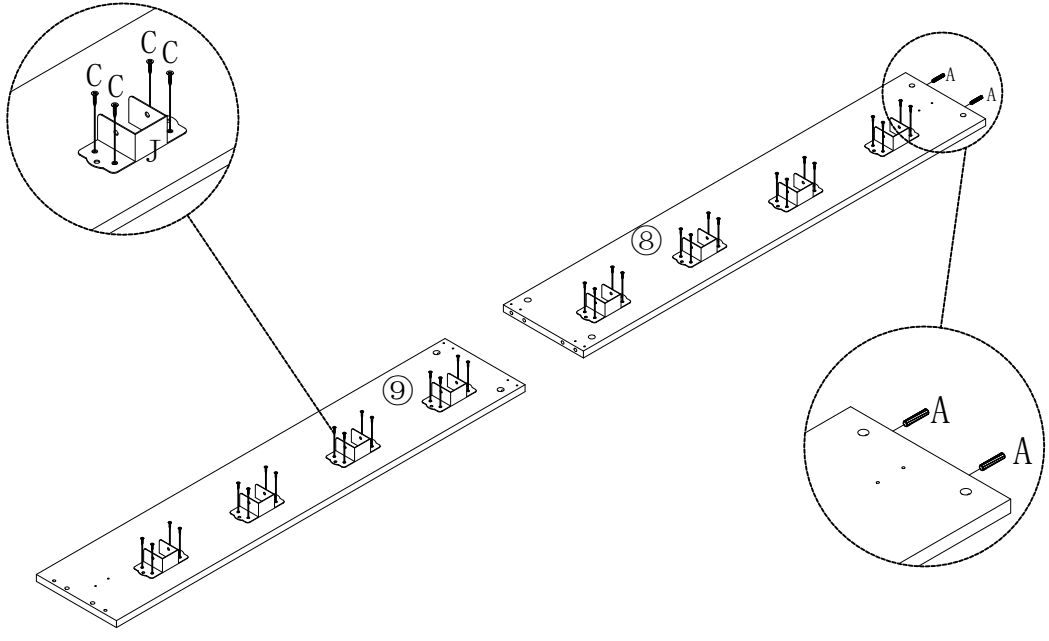



STEP 16

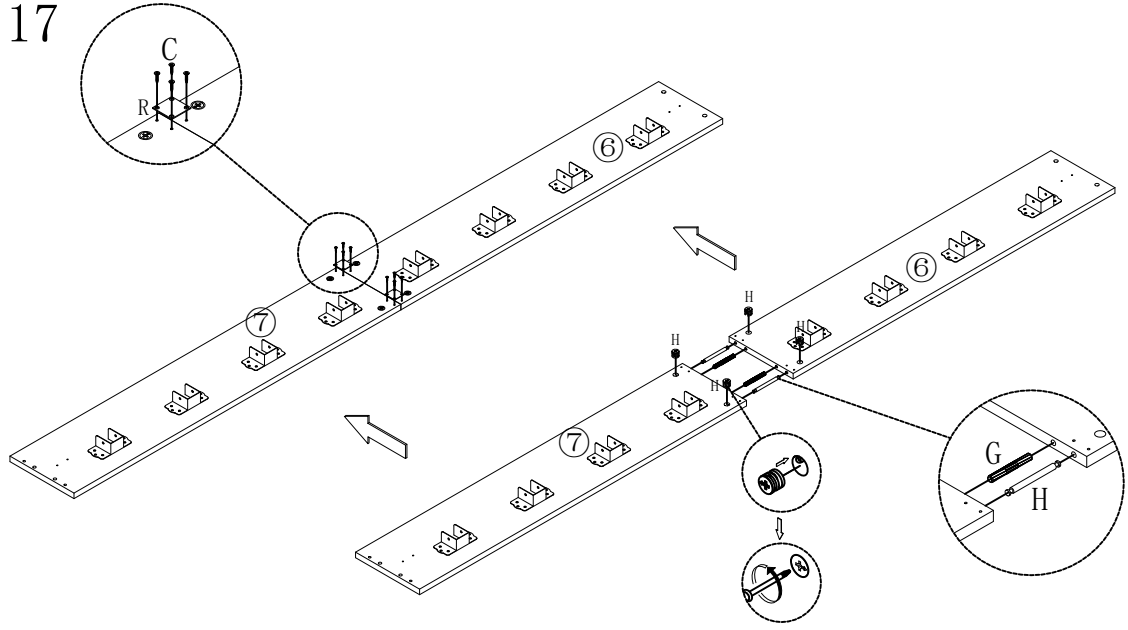

	Cx32pcs		Jx8pcs		Ax2pcs
---	---------	---	--------	---	--------



STEP 17

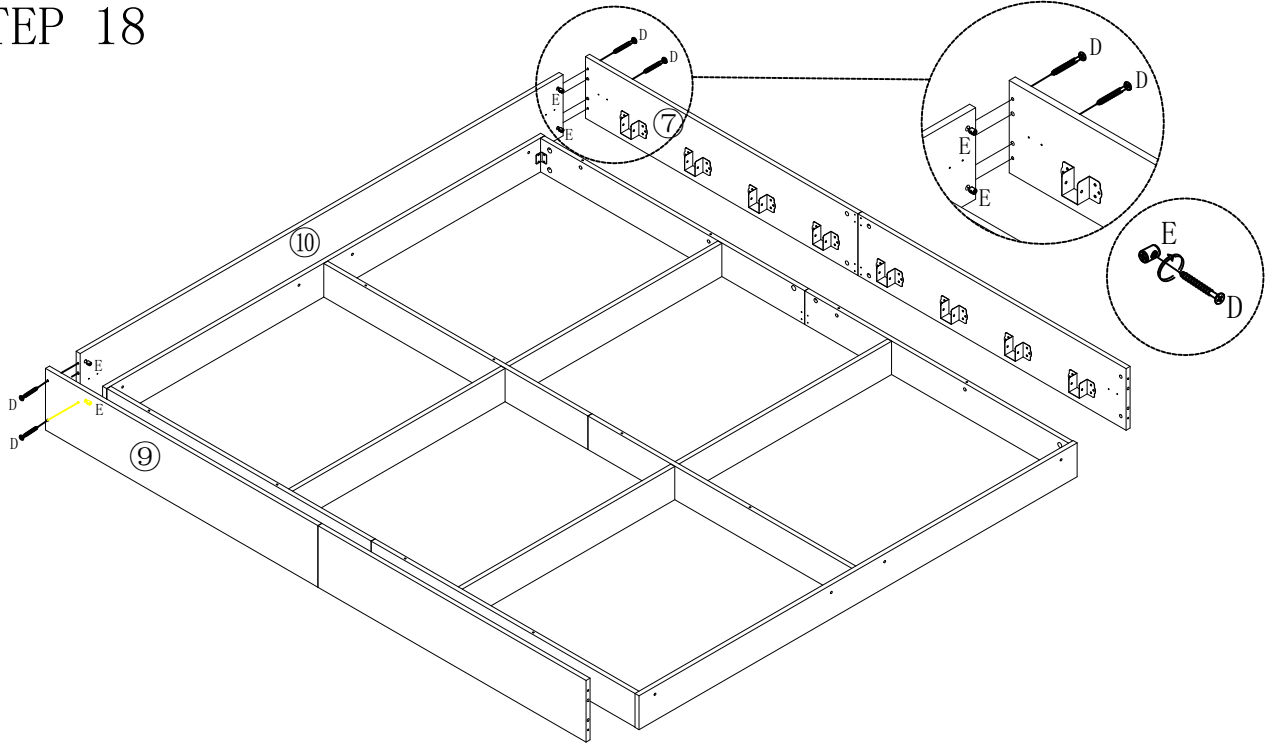

	Cx8pcs		Hx2sets		Rx2pcs		Gx2pcs
---	--------	---	---------	---	--------	---	--------

STEP 18



	Dx4pcs		Ex4pcs
---	--------	---	--------

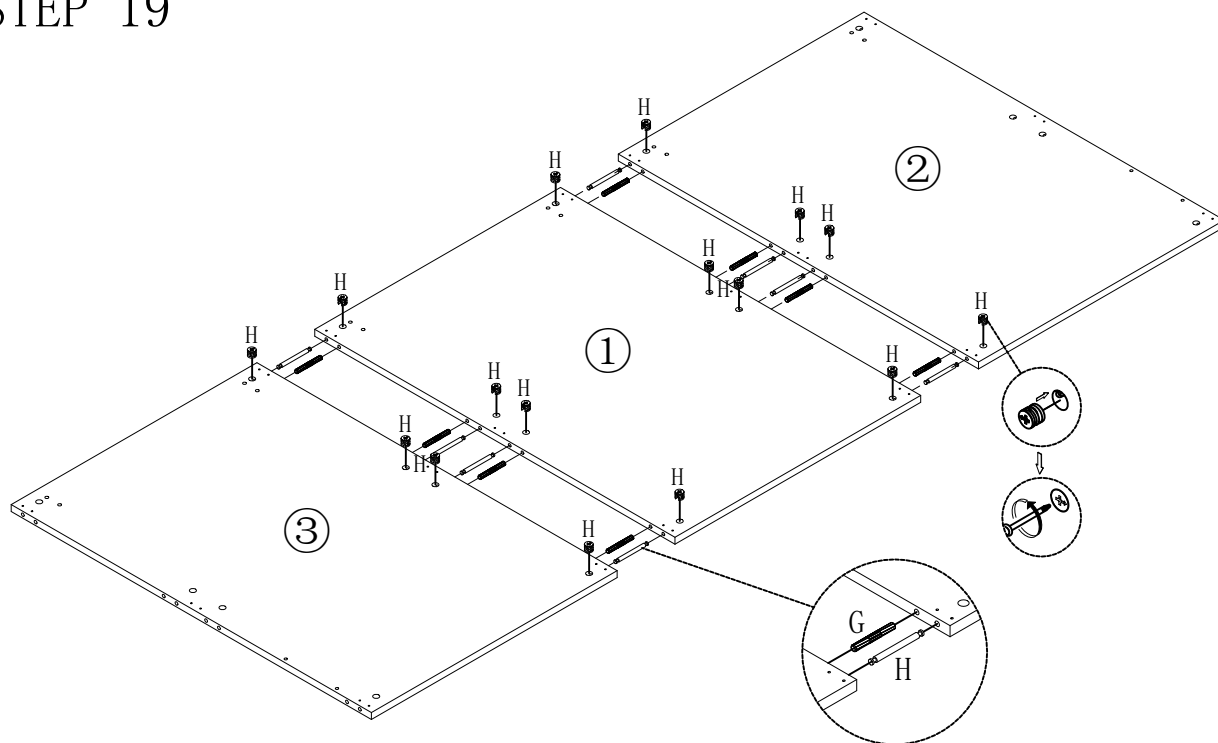

STEP 19

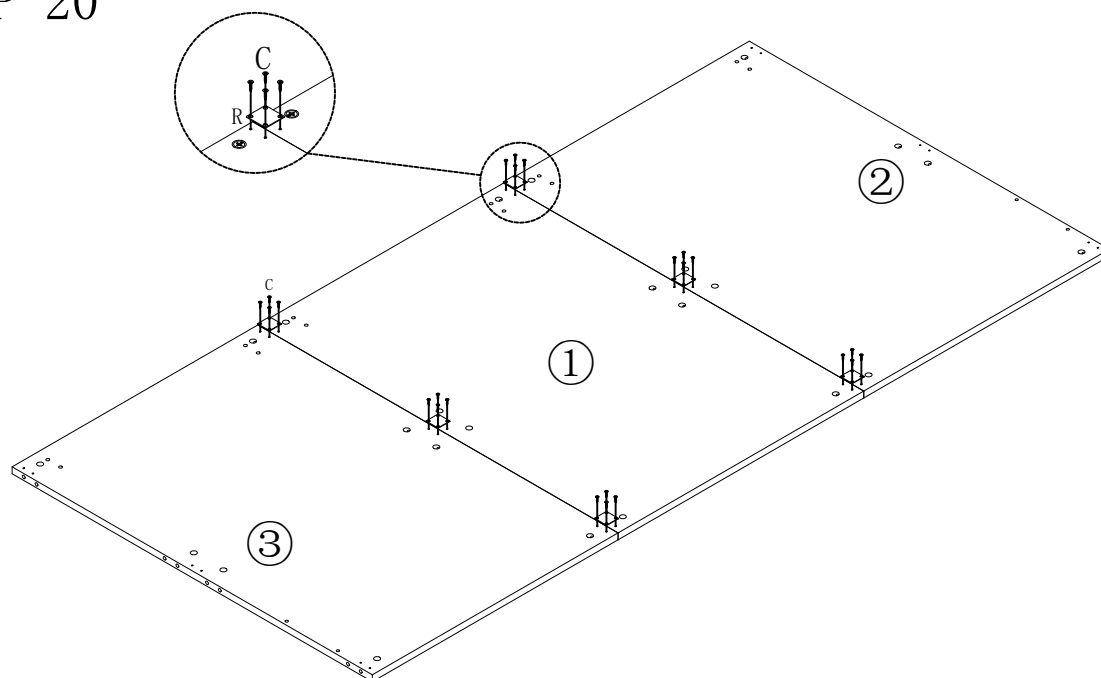

	Hx8sets		Gx8pcs
---	---------	---	--------

STEP 20



	Cx24pcs		Rx6pcs
---	---------	---	--------

STEP 21

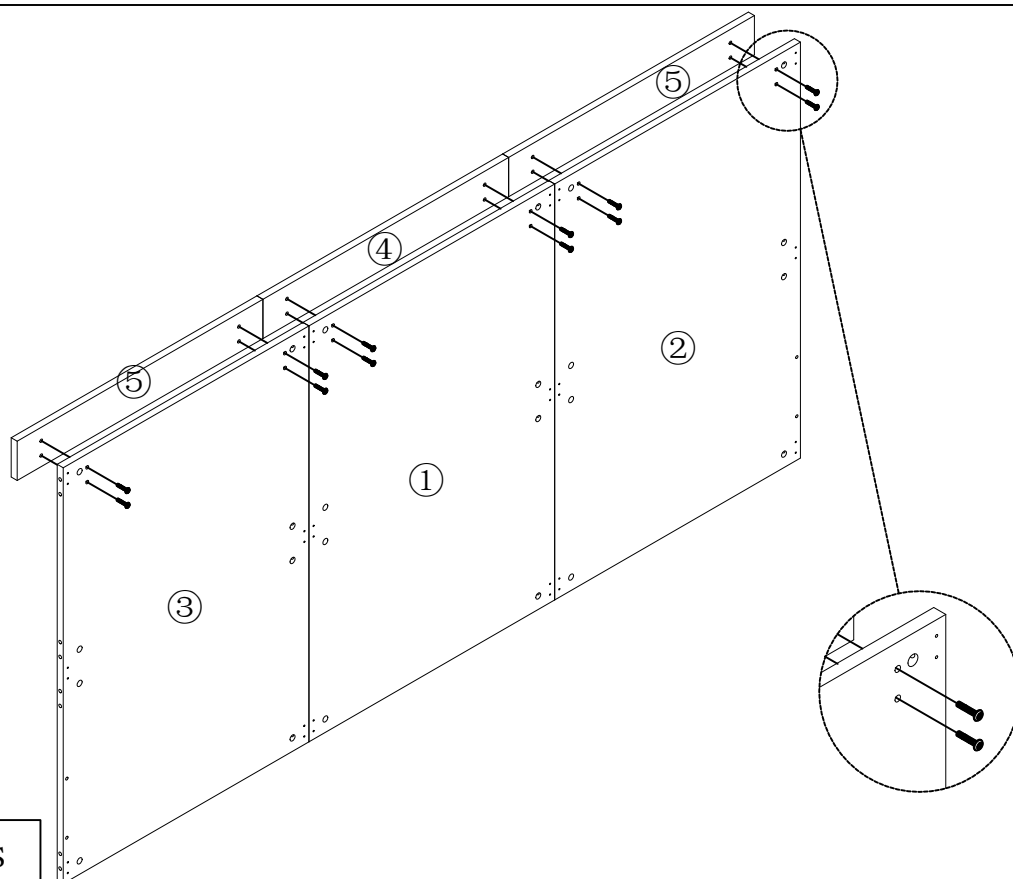

Fx12pcs

STEP 22

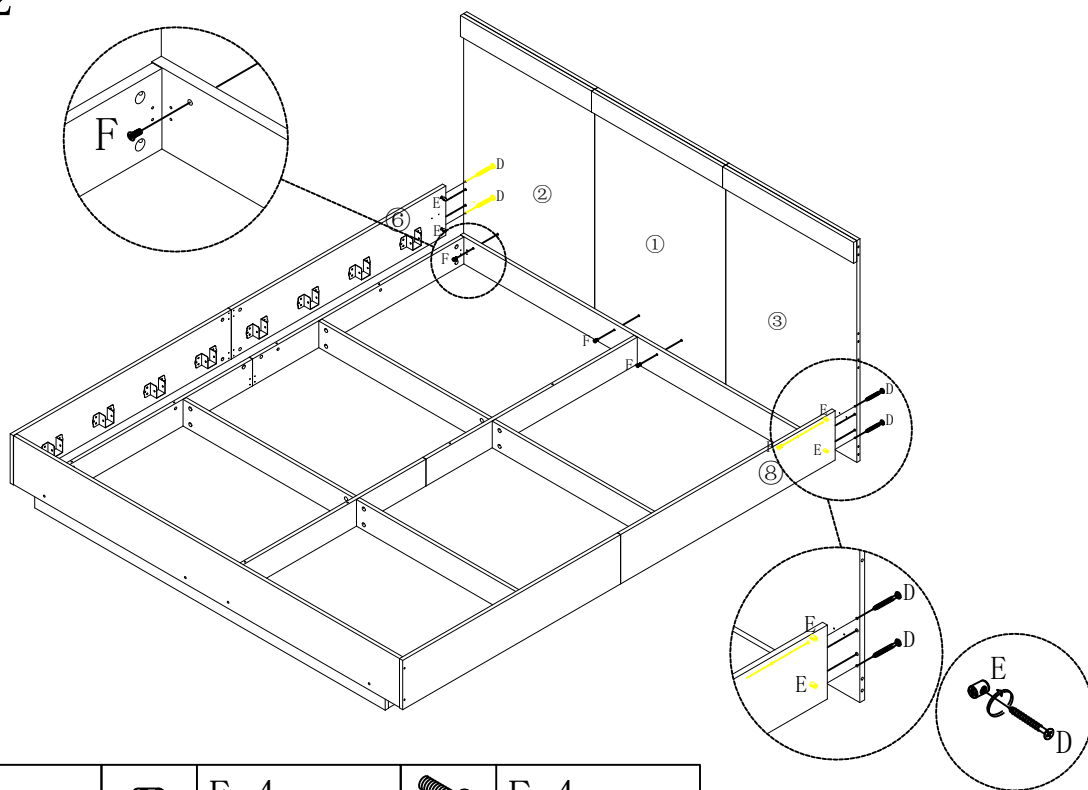

Dx4pcs







Ex4pcs

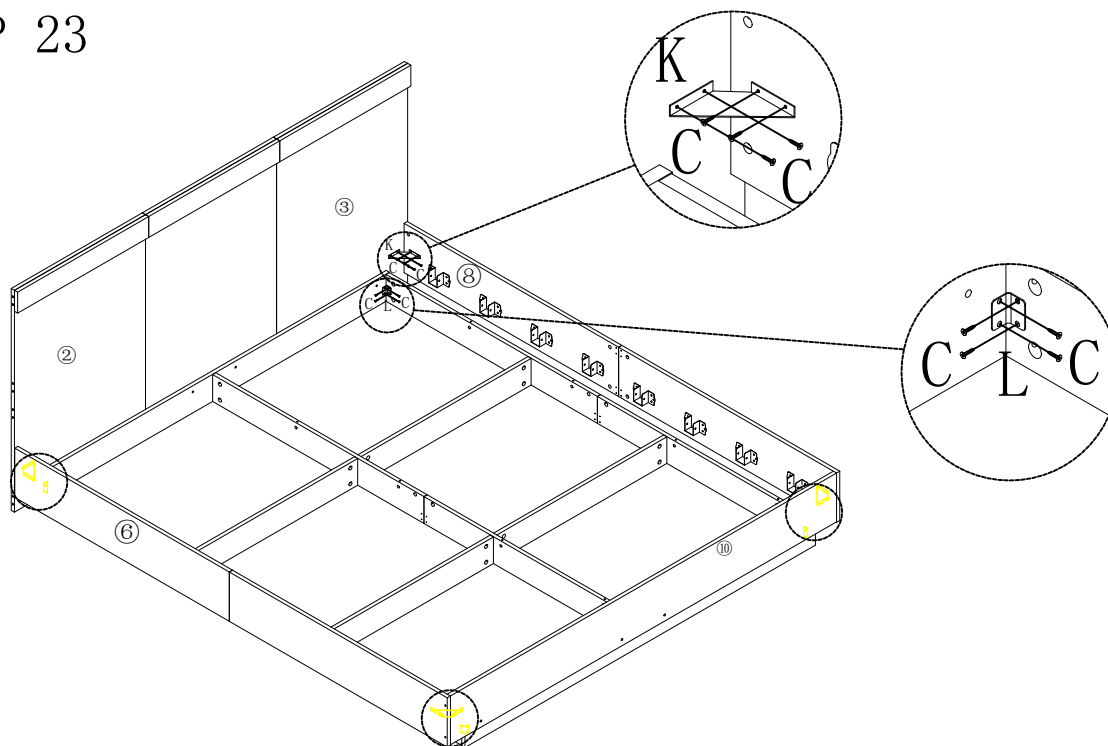

Fx4pcs



STEP 23

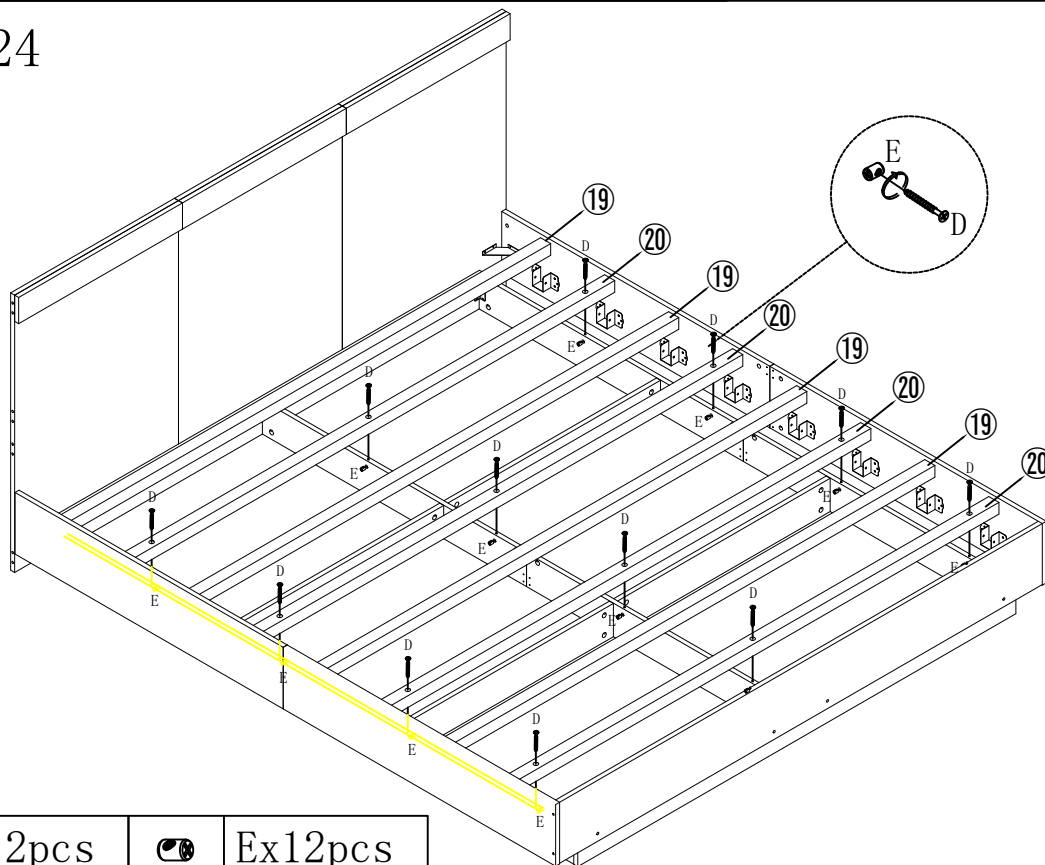

	Cx32pcs		Kx4pcs		Lx4pcs
---	---------	---	--------	---	--------

STEP 24



	Dx12pcs		Ex12pcs
---	---------	---	---------