

84852 Drehstuhl mit Armlehnen Mila Grün

EAN: 4025621848523

KARE
DESIGN

Email: info@kare.de

KARE Design GmbH Zeppelinstraße 16, 85748 Garching-Hochbrück Germany

Geschäftsführende Gesellschafter: Jürgen Reiter, Peter Schönhofen

KARE Design GmbH HRB 164 249 Amtsgericht München Sitz: München Steuernummer: Finanzamt München für Körperschaften,
143/153/40064 USt-ID: DE 250 622 249

www.kare.de www.kare-design.de

RISK OF TIPPING

SAFETY INSTRUCTION



GB: Risk of tipping ! Please do not swing the stool! Do not stand on the stool!

D: Kippgefahr ! Bitte mit dem Stuhl nicht schaukeln! Nicht auf dem Stuhl stehen!

FR: Risque de basculement ! S'il vous plaît ne pas se balancer sur le tabouret ! Ne pas monter sur le tabouret !

NL : Kantelgavaar ! Gelieve niet te schommelen op de kruk ! Ga niet op de kruk staan !

IT: Rischio di ribaltamento ! Non dondolare con lo sgabello ! Non montare sullo sgabello !

RU: Опасность опрокидывания ! Пожалуйста на стуле не качаться, на стул ногами не вставать!

PL: Ryzyko wywrocenia. Proszę nie chustac się na krzesle. Nie stawac na krzesle.

TR: Devrilme tehlikesi var! Sandelye üzerinde sallanmayınız! Sandelyenin üzerinde ayakta durmayınız!

RO: Risc de răsturnare ! Vă rugăm să nu vă balansați pe scaun! Nu stați în picioare pe scaun !

SK: Varovanie, možnosť úrazu! Prosíme, aby ste sa nehojdali na stoličke! Nestojte na stoličke!

CZ: Riziko převrácení! Nehoupejte se na stoličce! Nestoupejte na stoličku!

HU: Vigyázz! Borulekony! Räälni tilos!

BG: Опасност от преобръщане! Моля, не клатете стола! Не стойте върху стола!

DK: Fare for at vælte! Lad være med at vippe med stolen! Stå ikke på stolen!

EST: Kukkumisoht! Palun ärge kiigutage tooli! Ärge seiske tooli peal!

FN: Kaatumisvaara! Älä keinuta tuolia! Älä seiso tuolin päällä!

GR: Κίνδυνος ανατροπής! Μην κουνάτε την καρέκλα! Μην στέκεστε πάνω στην καρέκλα!

LV: Apgāšanās bīstamība! Lūdzu, nešūpojiet krēslu! Nestāviet uz krēsla!

LTU: Apvirtimo pavojus! Prašome nejudinti kėdės! Nestovėkite ant kėdės!











PRT: Perigo de queda! Não balançar a cadeira! Não se apoie na cadeira!

SWE: Risk för tippning! Vänligen gunga inte stolen! Stå inte på stolen!

SVN: Nevarnost prevrnitve! Stola ne zibajte! Ne stojte na stolu!

ESP: ¡Peligro de vuelco! No balancee la silla. No se suba a la silla.

KARE DESIGN 84712 / 84852 Chair With Armrest Mila

	 ① x1	 ② x1	 ③ x4	 M6 x 30 ④ x2	 M6 x 35 ⑤ x2
	 M6 x 12 ⑥ x4	 M6 x 12 ⑦ x4	 φ16/φ6 ⑧ x8	 4# ⑨ x1	

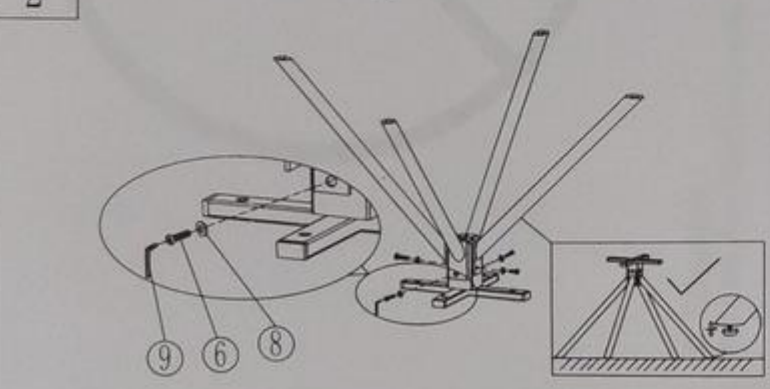
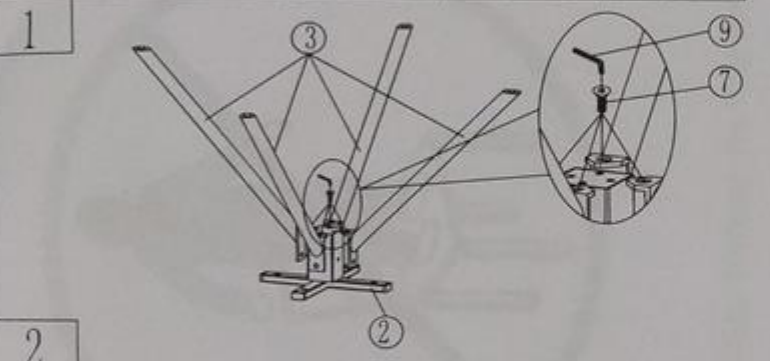

3

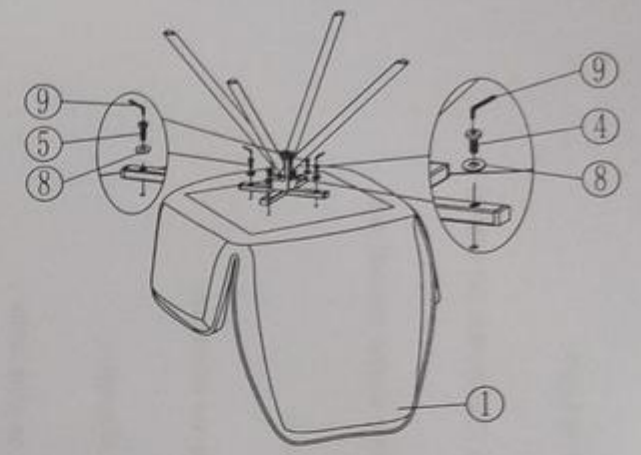

4

