

TRIPLO

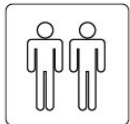

- (D) Montageanleitung
- (FR) Notice de montage
- (NL) Handleiding voor de montage
- (CZ) Montážní návod
- (HU) Szerelési útmutató
- (TR) Montaj talimatı
- (GB) Assembly instructions
- (IT) Istruzioni di montaggio
- (PL) Instrukcja montażu
- (SK) Návod na montáž
- (RO) Instrucțiunile de montaj
- (RU) ИНСТРУКЦИЯ ПО МОНТАЖУ

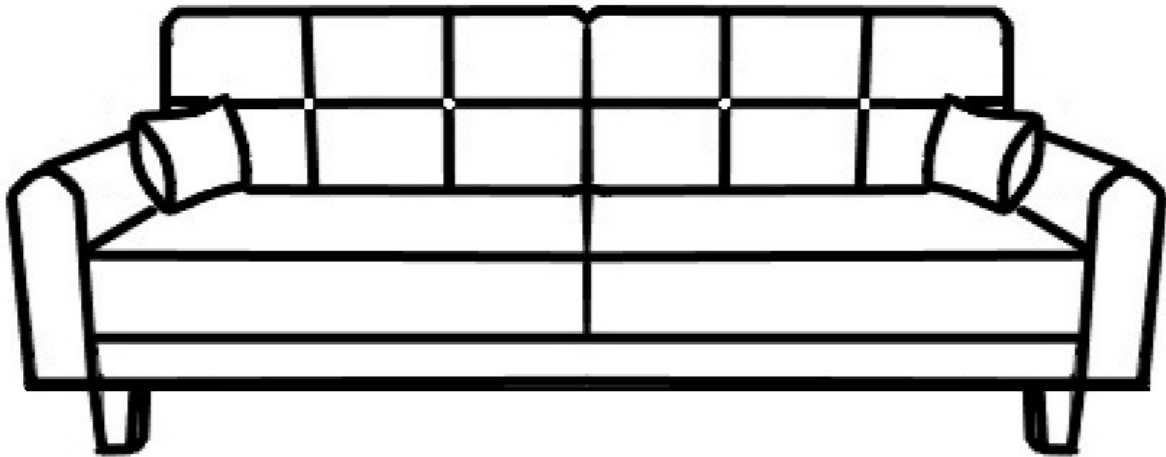

1

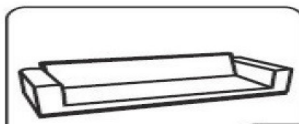
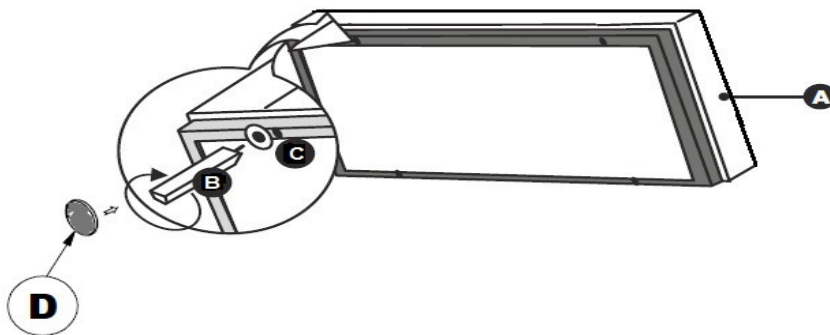

Ax1

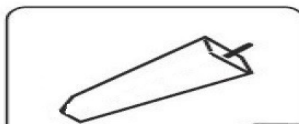

Bx4

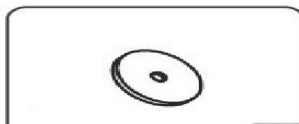

Cx4

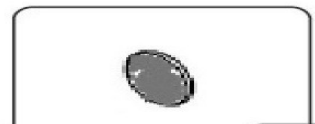

Dx4

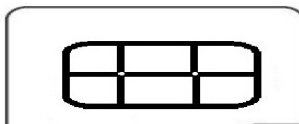

Ex2

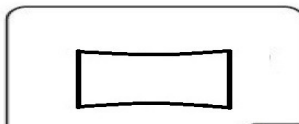

Fx2



0-6

