

D Montageanleitung

GB Assembly instructions

FR Notice de montage

IT Istruzioni di montaggio

NL Handleiding voor de montage

PL Instrukcja montażu

CZ Montážní návod

SK Návod na montáž

HU Szerelési útmutató

RO Instrucțiuni de montaj

TR Montaj talimatı

RU Инструкция по монтажу

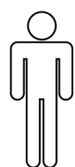

Service • Assistent • Dienstverlening • Serwis
 Servis • Szerviz • Сервисная служба

Name • Nom •
 Nome • Naam •
 Nazwa • Jméno •
 Názov • Név •
 Denumire • Isim •
 Название

Nr. • No. • N° •
 Номер • Č • Sz

6373 0326

Tur • Type • Tip •
 Típus • Típo
 Тип

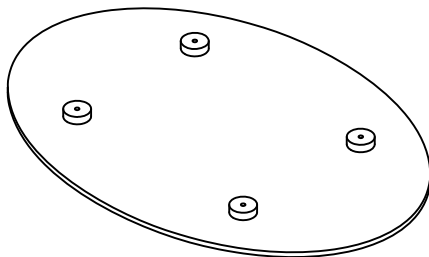
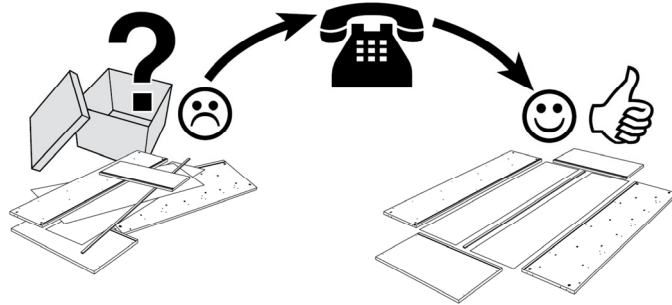
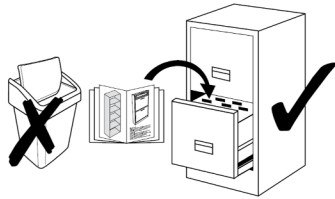

① 1X

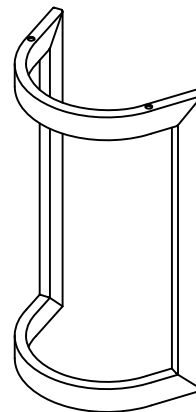

② 2X

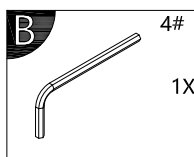
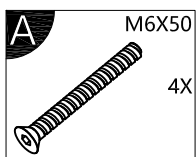

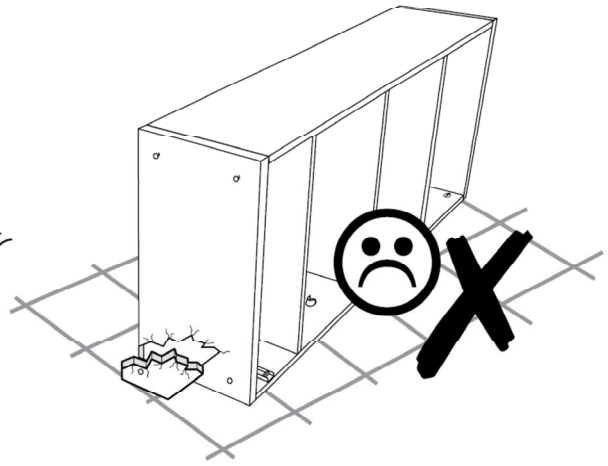
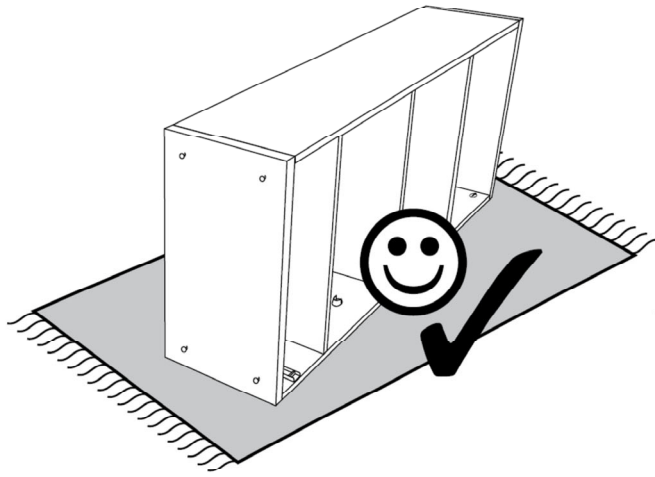

1

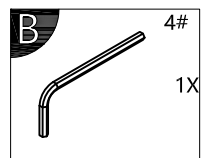
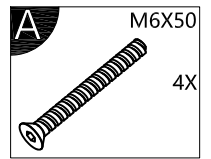
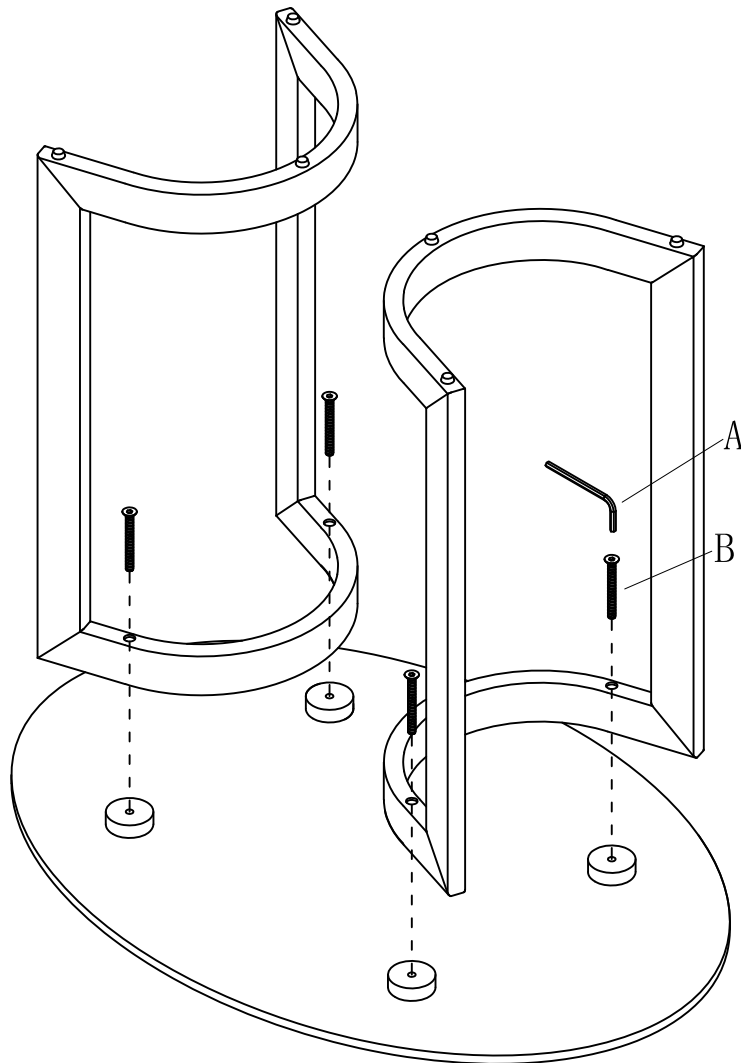

○
Kg Max
20Kg

