

MONTAGEANLEITUNG

Artikelnummer: WF300892

WF300893

WF305343

Dieses Set ist in 3 Boxen enthalten. Wenn Sie keine vollen 3 Boxen erhalten, wenden Sie sich bitte an unseren Kundenservice

Etagenbett 200 x 140 cm



! SICHERHEITSWARNUNGEN!

1. Wir danken Ihnen für den Einkauf! Wir haben daran gearbeitet, Ihnen Produkte mit hoher Qualität anzubieten. Im seltenen Fall, dass Ihr Produkt beschädigt ist, Teile fehlen oder Sie auf Probleme bei der Montage stoßen, wenden Sie sich damit bitte an unseren Kundendienst um die fehlenden Teile, die Montagevorschläge und die Garantieansprüche zu erreichen. Wir werden Ihnen die beste Lösung schnellstmöglich anbieten. Um Ihr Problem schneller zu lösen, bitte stellen Sie uns einige Bilder zur Verfügung, die das Produktproblem deutlich widerspiegeln können. Vielen Dank!
2. Setzen Sie die Schrauben vor Abschluss der Montage in die Löcher ein, ziehen Sie die Schrauben fest, aber nicht zu 100% festziehen. 70% sind in Ordnung. Schließlich, wenn es kein Problem mit der Montage gibt, dann ziehen Sie alle Schrauben zu 100% fest. Wenn Sie diese Probleme auftreten, z.B. falls die Löcher nicht ausgerichtet werden können oder einige Teile nicht installiert werden können, überprüfen Sie bitte die Schrauben und stellen Sie die Dichtheit der Schrauben ein.
3. 2 Personen werden empfohlen, die Installation durchzuführen.



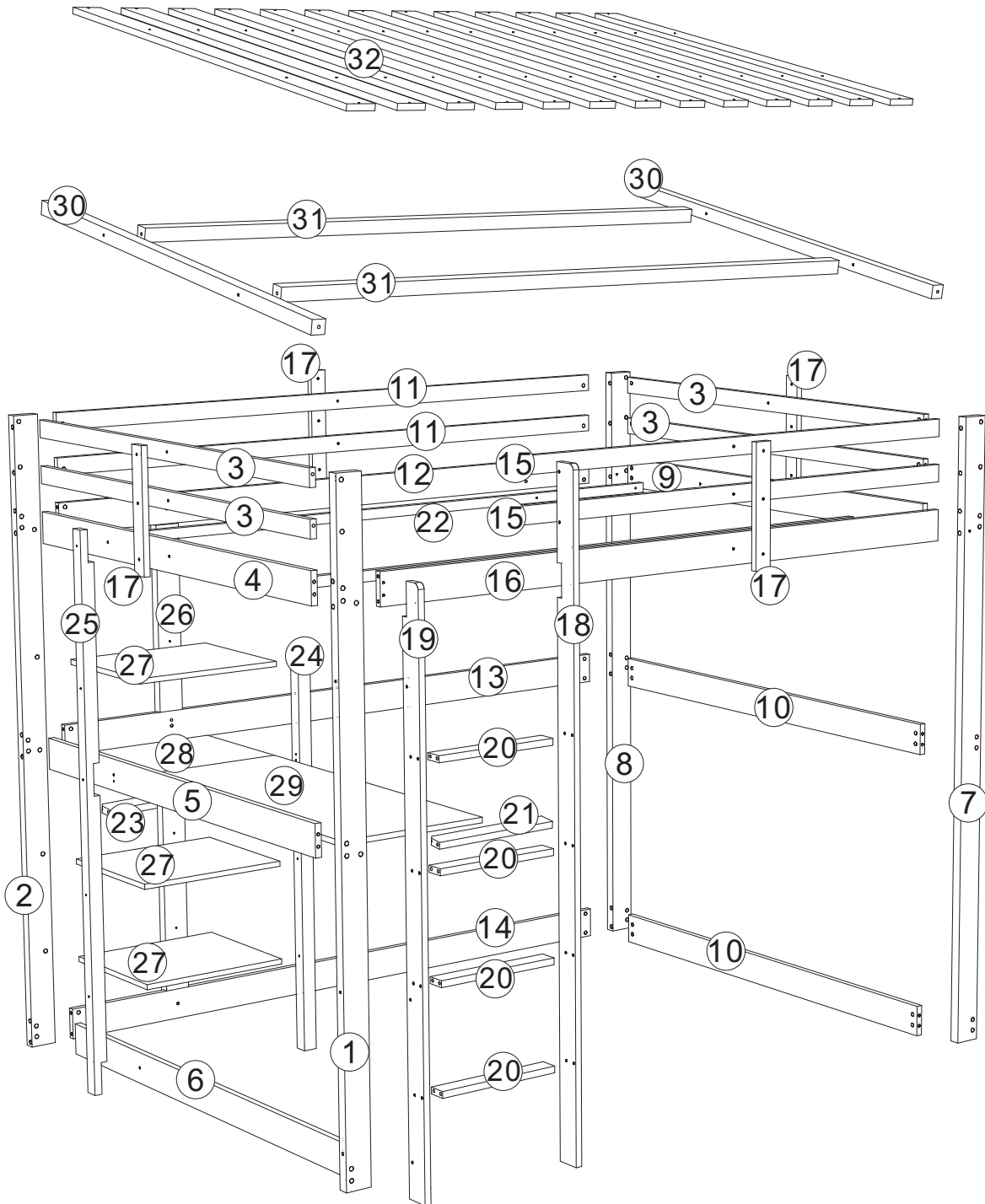

! SAFETY WARNINGS!

1. Please read the instructions fully before assembly. These instructions include important information which could ensure correct assembly. We have been working on providing high quality products for you. However, in the rare instance that your product is defective, missing parts or there are some issues, please don't hesitate to contact our customer service to submit parts requirements, assembly suggestion, or warranty claims and we will give the best solution as soon as possible. If necessary, we need you to provide some more clear pictures of the issue.
2. Insert the screws in holes and tighten the screws, but not too tight, 70% is ok, finally tighten all the screws. If some issues happened that some screws can not target to the hole or some parts are difficult to install, please adjust the tightness of the screws.
3. 2 people are recommended to finish



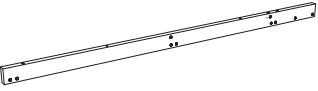
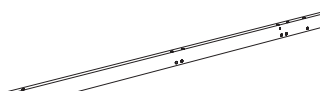
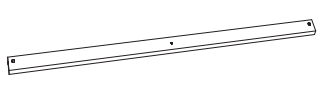
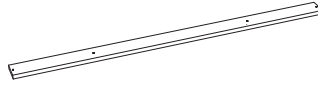

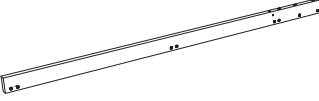
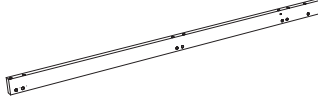
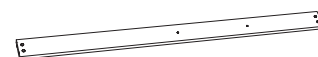

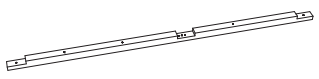
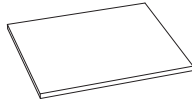
Stückliste



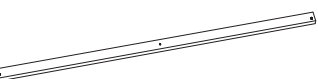
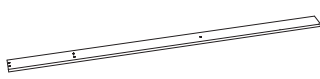

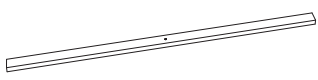
WF 300892

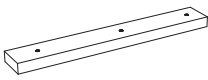
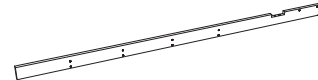
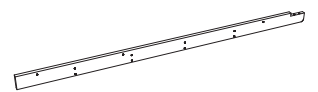
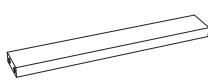
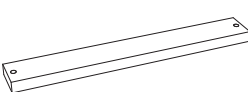
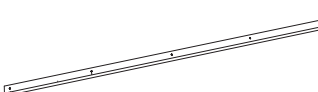
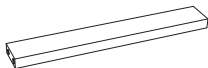
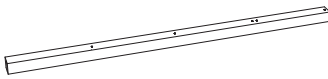
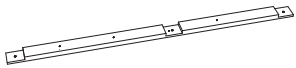
1  1stck	2  1stck	3  4stck	4  1stck
5  1stck	6  1stck	7  1stck	8  1stck
9  1stck	10  2stck	26  1stck	27  3stck

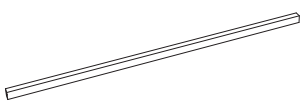



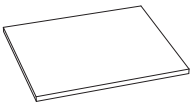
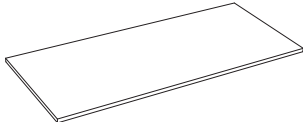







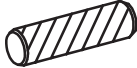

WF 300893

11  2stck	12  1stck	13  1stck	14  1stck
15  2stck	16  1stck	17  4stck	18  1stck
19  1stck	20  4stck	21  1stck	22  2stck
23  1stck	24  1stck	25  1stck	30  2stck
31  2stck			

WF 305343

<p>28</p>  <p>1 stck</p>	<p>29</p>  <p>1 stck</p>	<p>32</p>  <p>13 stck</p>	
---	---	---	--



WF 300893

<p>A</p>  <p>Ø1/4" x 80mm 22 stck</p>	<p>B</p>  <p>Ø1/4" x 55mm 56 stck</p>	<p>C</p>  <p>Ø1/4" x 35mm 23 stck</p>
<p>D</p>  <p>54 stck</p>	<p>E</p>  <p>Ø 8x20mm 4 stck</p>	<p>F</p>  <p>18 stck</p>
<p>G</p>  <p>M4x15 15 stck</p>	<p>H</p>  <p>M4x25 3 stck</p>	<p>I</p>  <p>M3.5x35mm 16 stck</p>
<p>J</p>  <p>M3x25mm 56 stck</p>	<p>K</p>  <p>1 stck</p>	<p>L</p>  <p>Ø1/4" x 40mm 2 stck</p>
<p>M</p>  <p>M3x30mm 8 stck</p>	<p>N</p>  <p>4 stck</p>	<p>O</p>  <p>4 stck</p>

Wichtiger Hinweis



Bestätigen Sie bitte alle Komponenten und Schrauben vor der Montage. Bitte wenden Sie sich an uns, falls einige Teile oder Schrauben im Paket fehlt sind.

Schritt 1

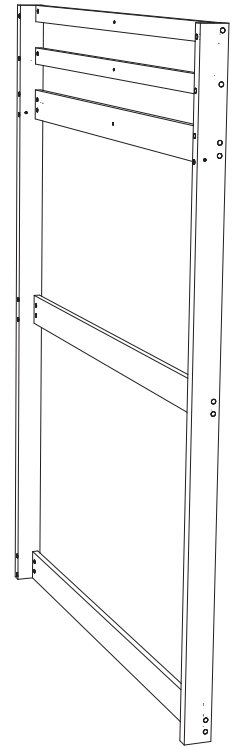
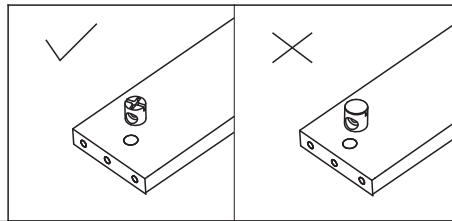
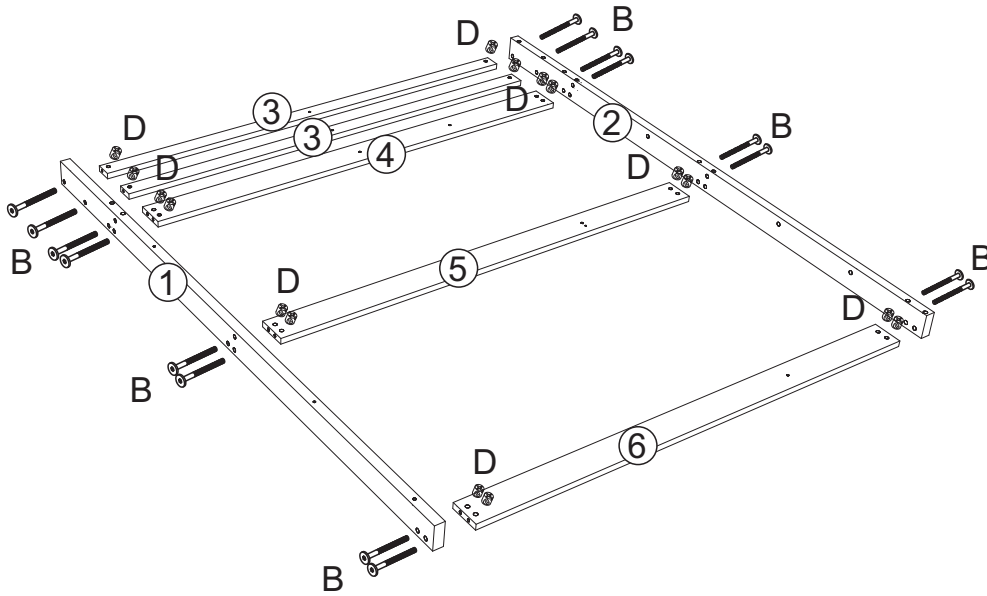
B		D	
16stck		16stck	



Schritt 2

B		D	
16stck		16stck	

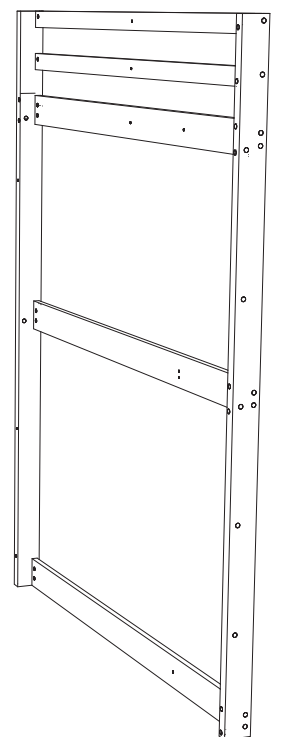
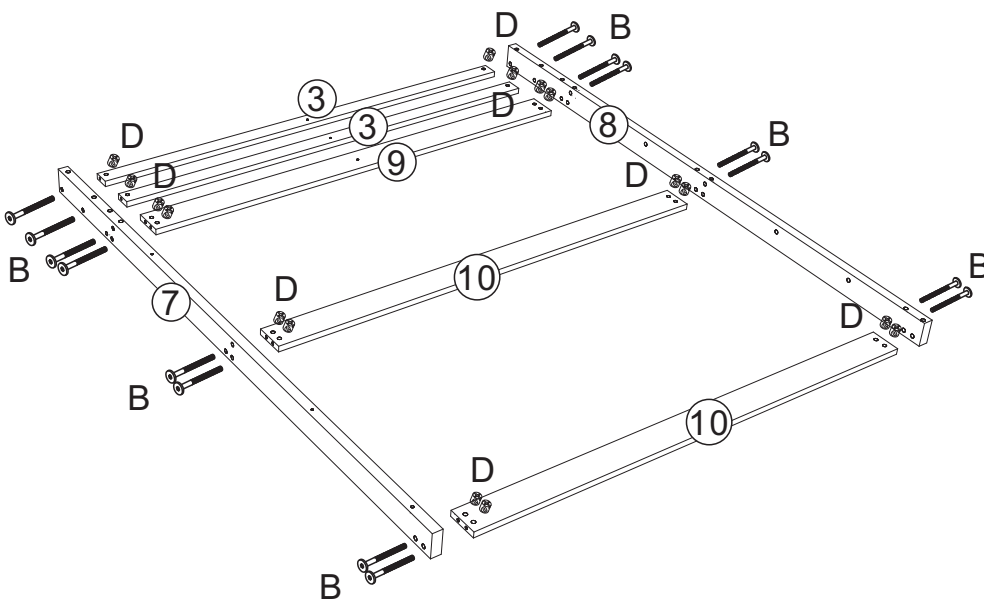

Schritt 3

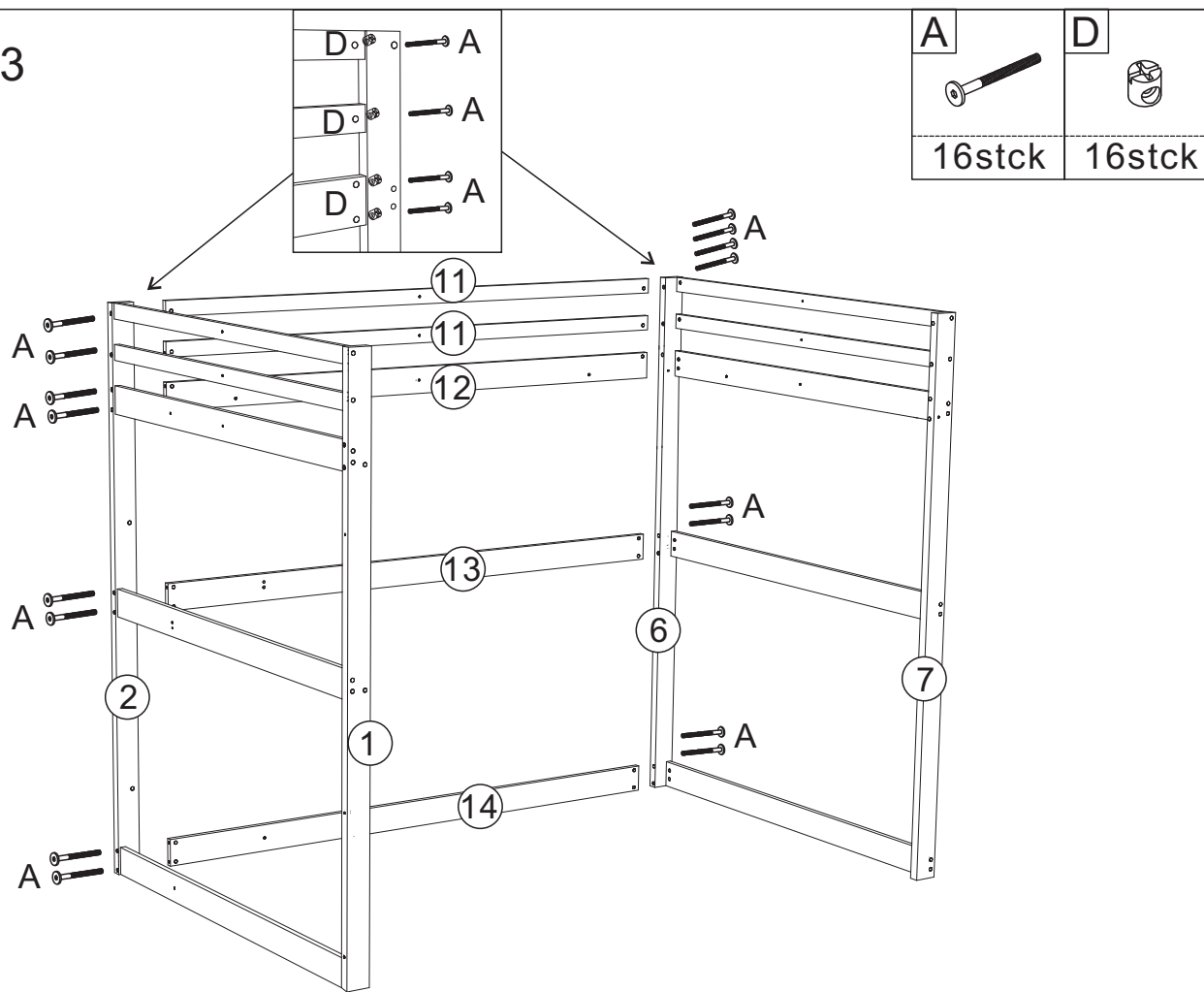

Schritt 4

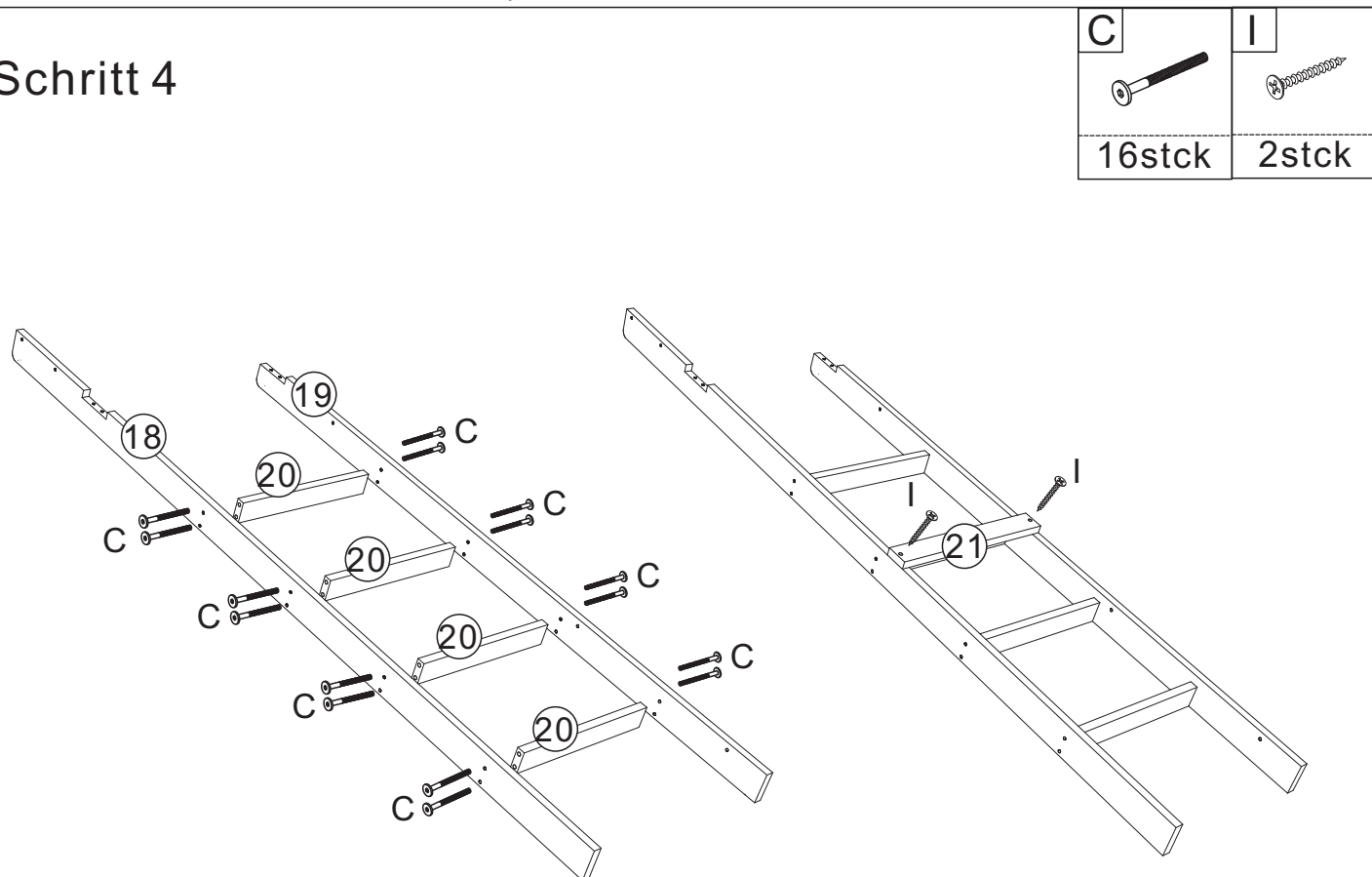



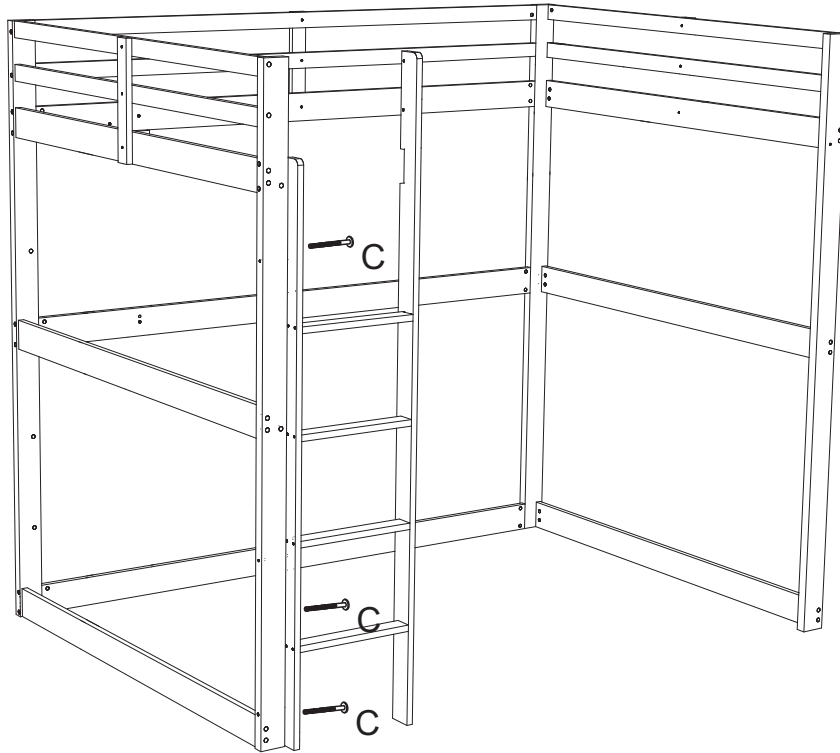

Schritt 5

C	
3stck	

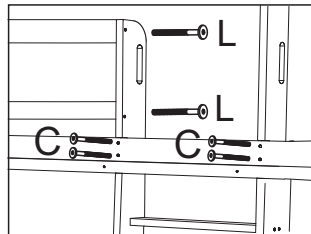

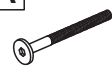
Schritt 6



A		C		D	
6stck		4stck		6stck	
L					
					
2stck					

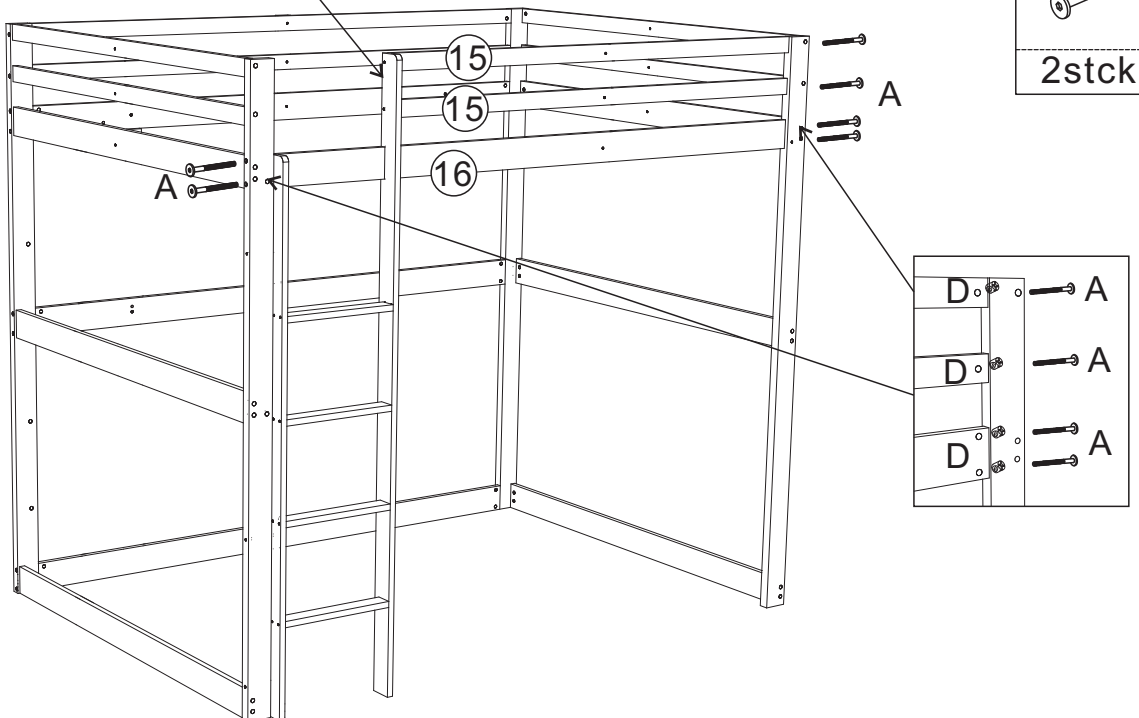

Schritt 7

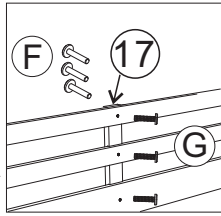

F		G	
	15stck		15stck

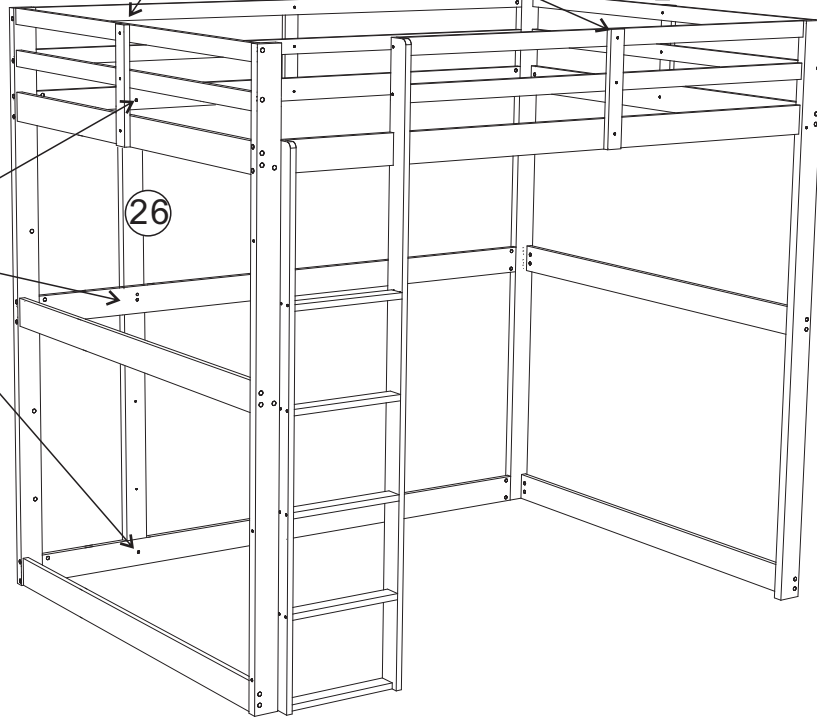
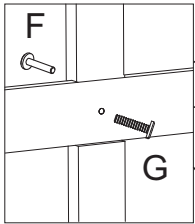

Schritt 8

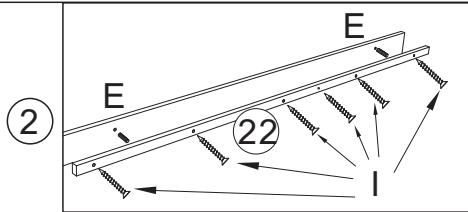

X2

B		F		H	
	2stck		3stck		3stck
E		I			
	4stck		12stck		

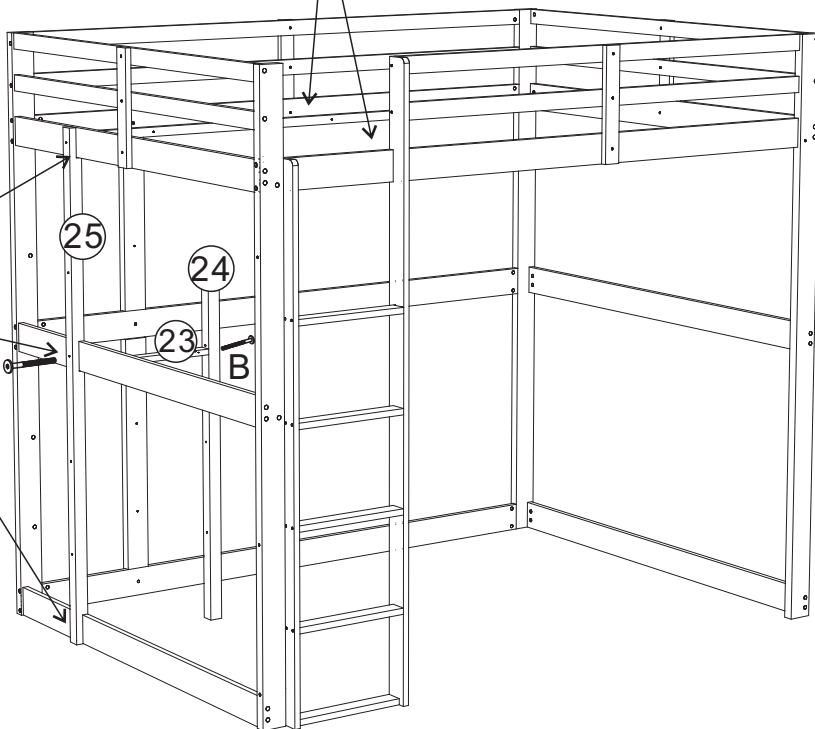
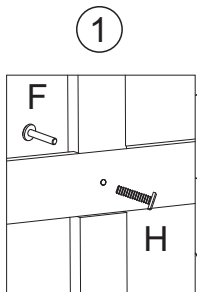

Schritt 9

B



14stck

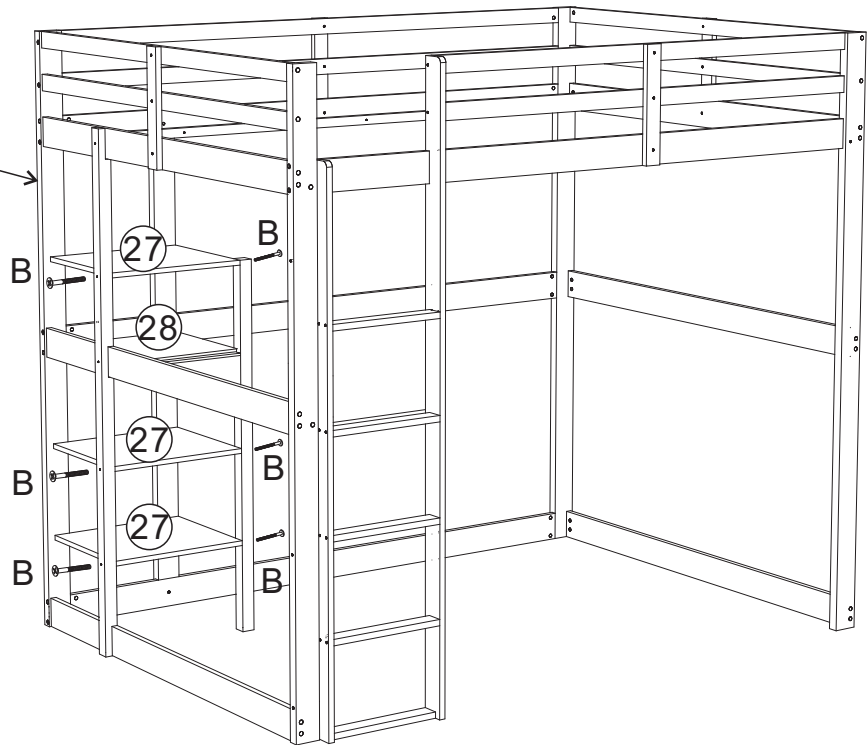
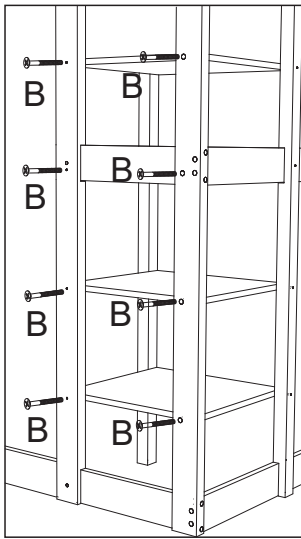

Schritt 10

I



2stck

J

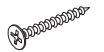

4stck

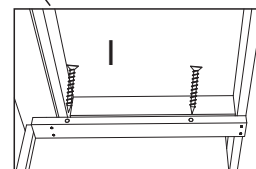
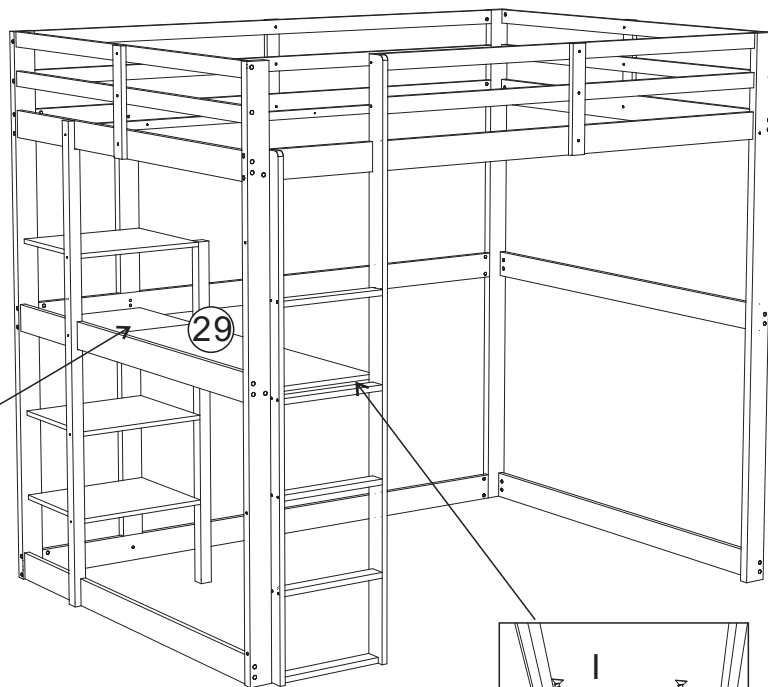
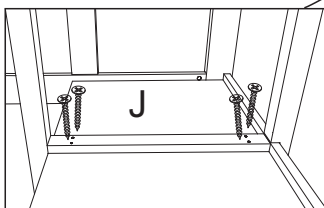

Schritt 11

B

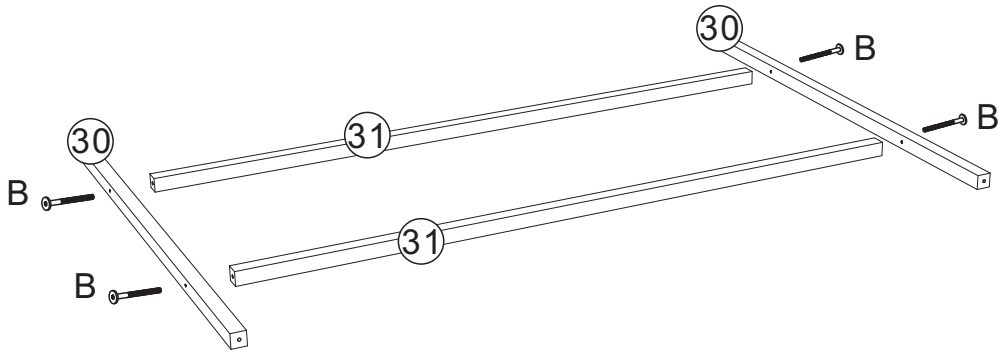
4stck



Schritt 12

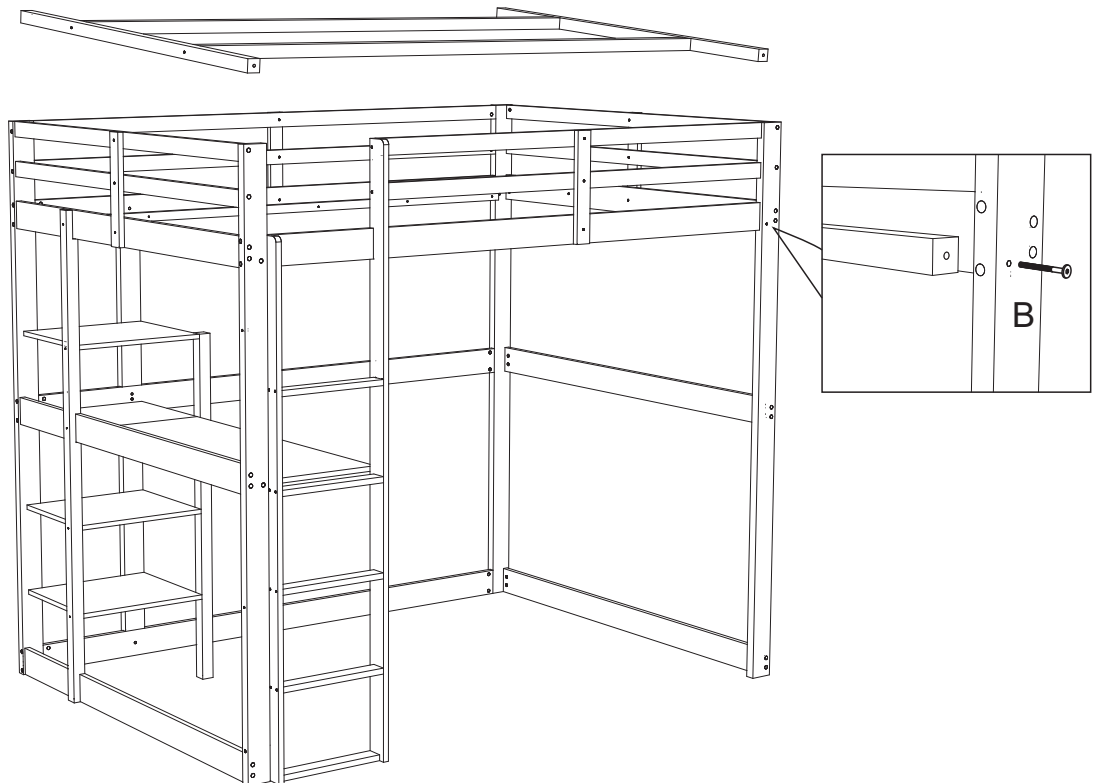

B

4stck

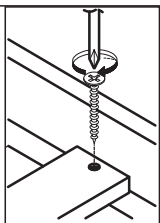

Schritt 13



32x13

J



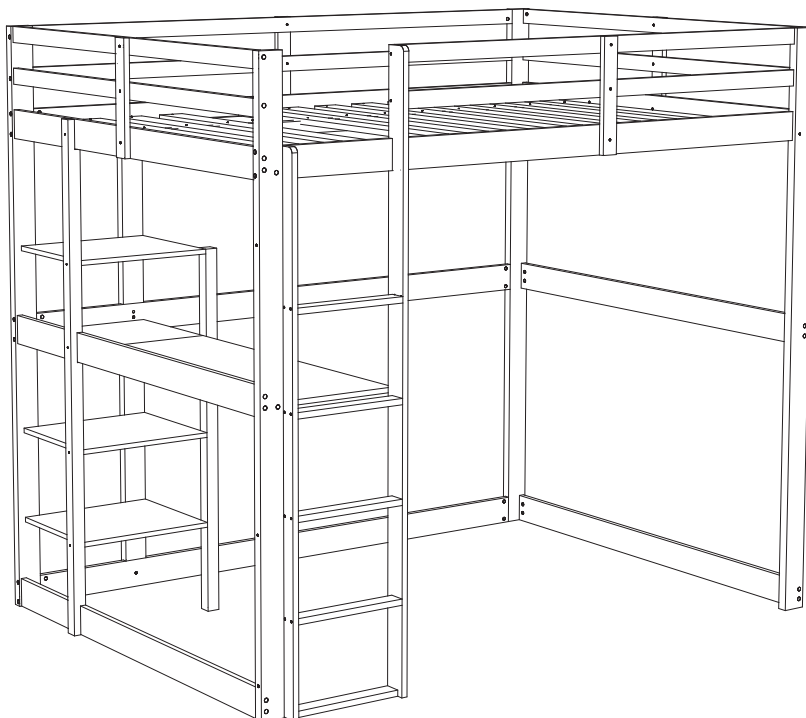

52stck

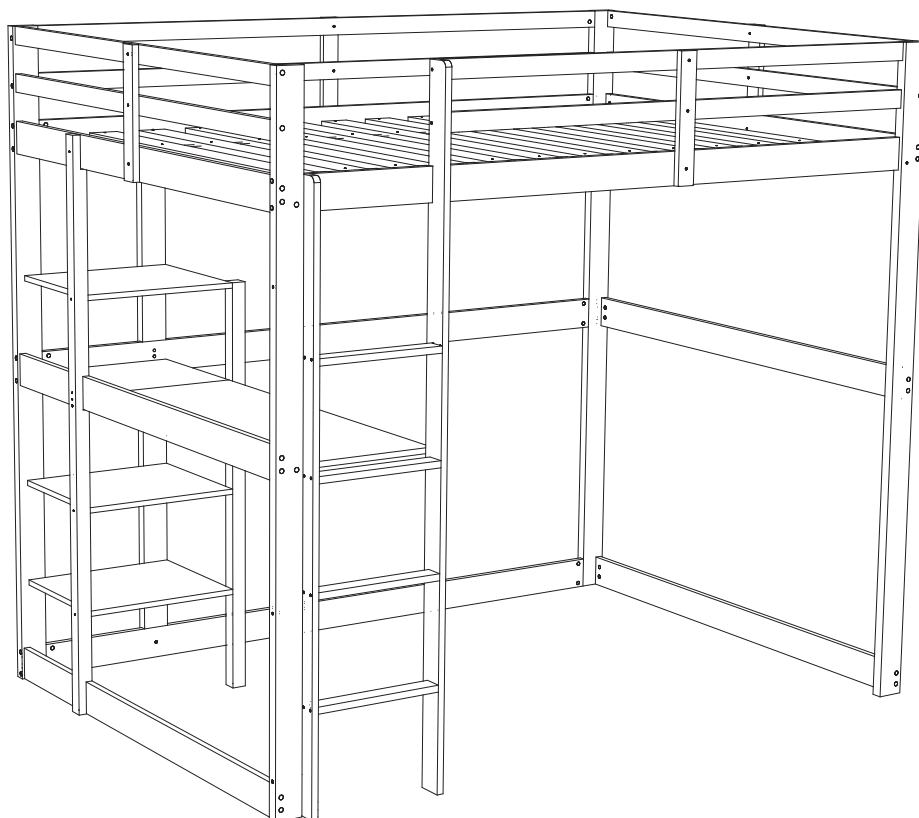

Schritt 14



Schritt 15

M	N
	
4stck	4stck

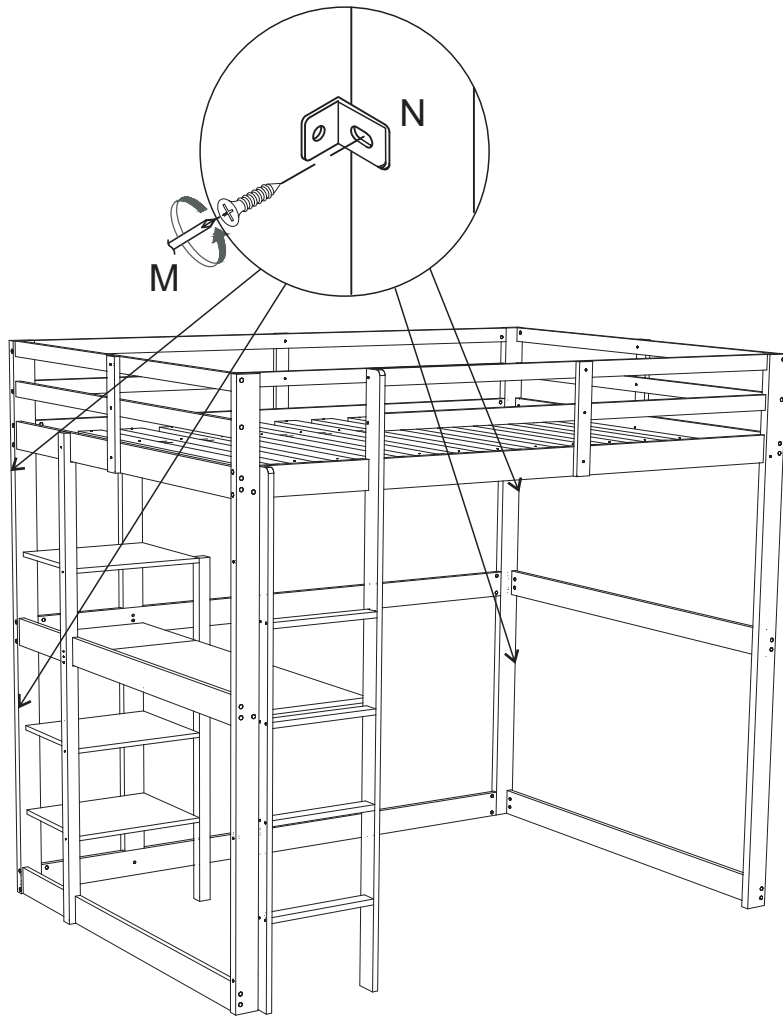

Schritt 16

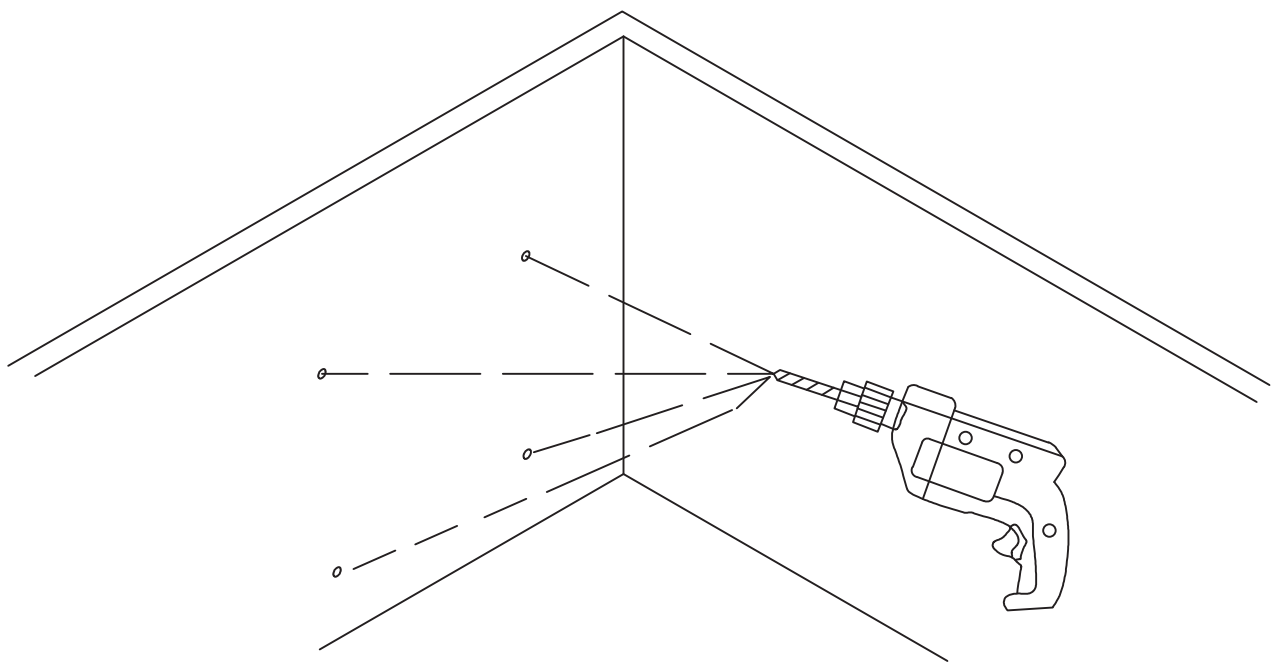

Schritt 17

O

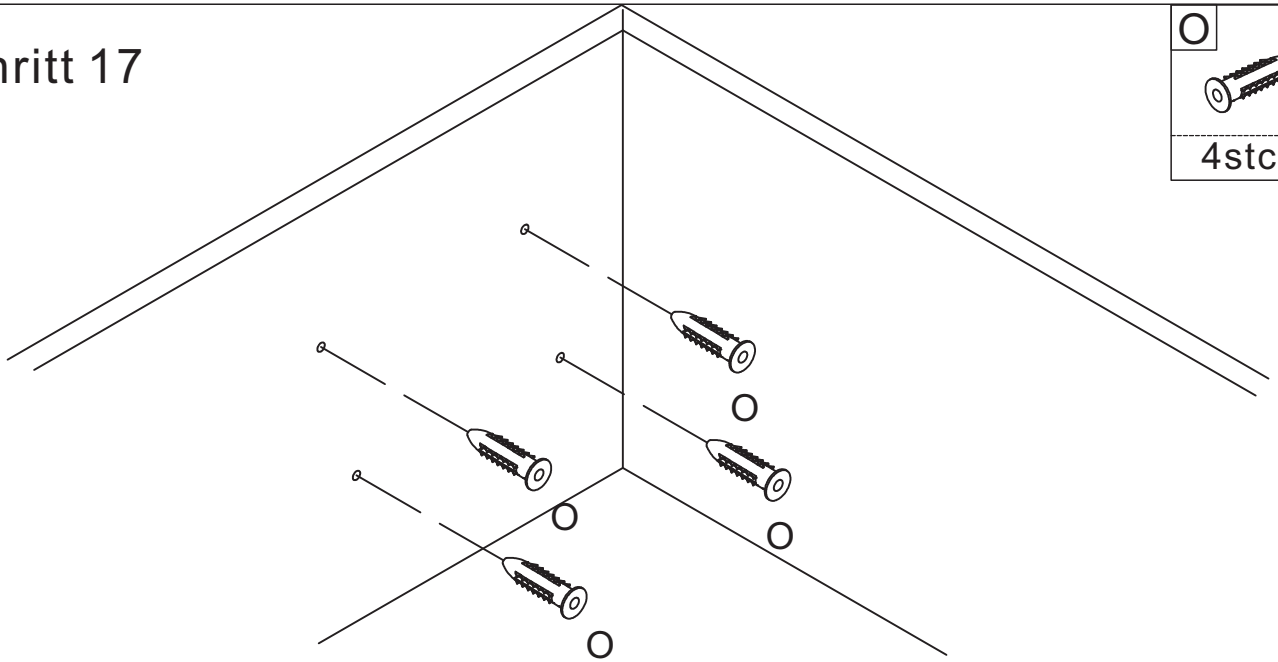
4stck



Schritt 18

M

4stck

