

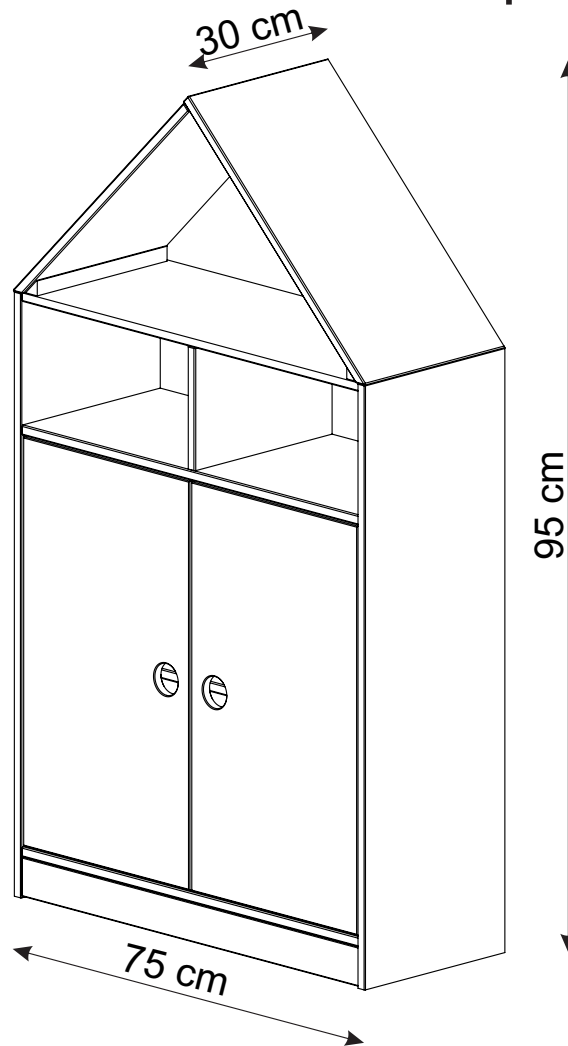

# Alpi 74197

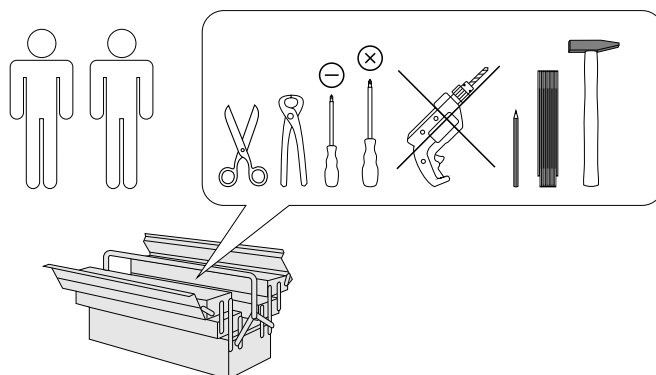





- |  |  |
|--|--|
| <b>(D)</b> Montageanleitung<br>74197             | <b>(GB)</b> Assembly instructions<br>74197   |
| <b>(FR)</b> Notice de montage<br>74197           | <b>(IT)</b> Istruzioni di montaggio<br>74197 |
| <b>(NL)</b> Handleiding voor de montage<br>74197 | <b>(PL)</b> Instrukcja montażu<br>74197      |
| <b>(CZ)</b> Montážní návod<br>74197              | <b>(SK)</b> Návod na montáž<br>74197         |
| <b>(HU)</b> Szerelési útmutató<br>74197          | <b>(RO)</b> Instrucțiuni de montaj<br>74197  |
| <b>(TR)</b> Montaj talimatı<br>74197             | <b>(RU)</b> Инструкция по монтажу<br>74197   |

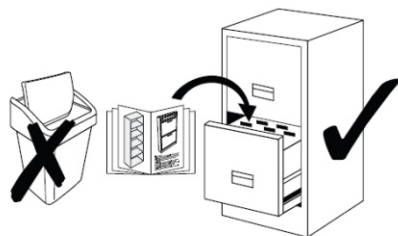
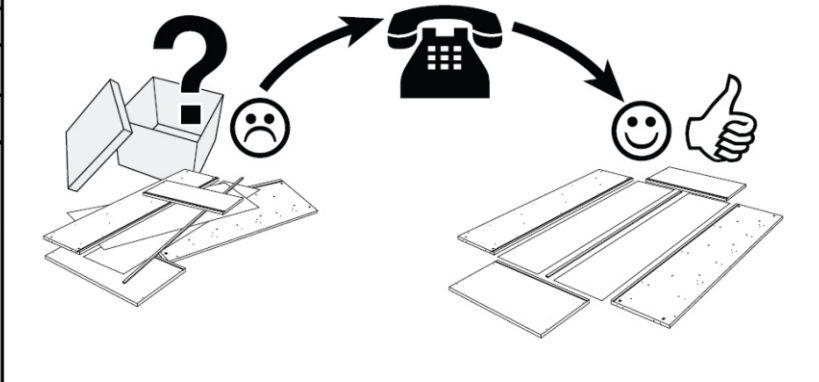

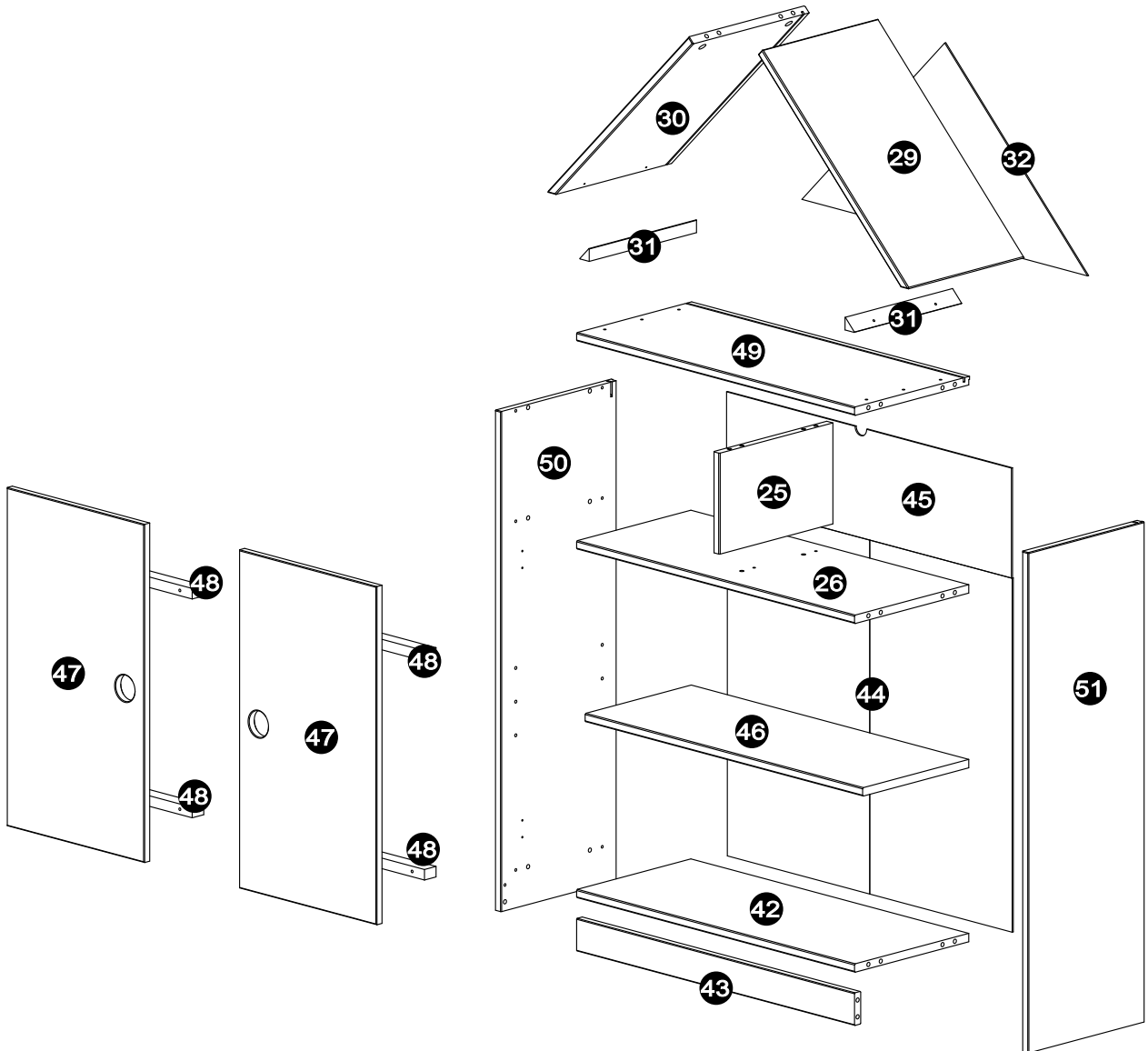
0  
10  
20  
30  
40  
50  
60  
70  
80  
90  
100  
110  
120  
130  
140  
150  
160  
170  
180  
190  
200

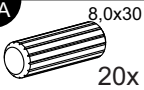
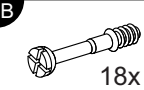
Service • Assistenza • Dienstverlening • Serwis Servis • Szerviz • Сервисная служба	
Name • Nom • Nome • Naam • Nazwa • Jméno • Názov • Név • Denumire • İsim • Название	
Nr. • No. • N° • Номер • Č • Sz	
Typ • Type • Tip • Típus • Tipo • Тип	
	
	

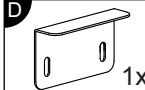
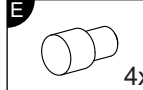
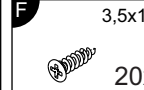
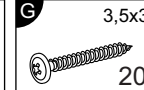

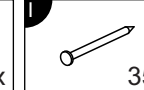
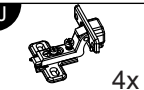
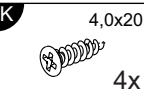
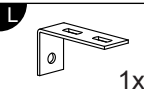
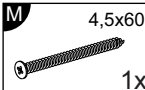
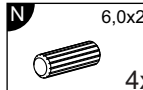
- |   |  |  |   |   |   |  |   |  |
|---|--|--|---|---|---|--|---|--|
| <b>A</b><br><br>20x | <b>B</b><br><br>18x | <b>C</b><br><br>18x | <b>D</b><br><br>1x | <b>E</b><br><br>4x | <b>F</b><br><br>20x | <b>G</b><br><br>20x | <b>H</b><br><br>5x | <b>I</b><br><br>35x |
| <b>J</b><br><br>4x  | <b>K</b><br><br>4x  | <b>L</b><br><br>1x  | <b>M</b><br><br>1x | <b>N</b><br><br>4x |   |  |   |  |

# 1

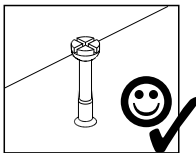
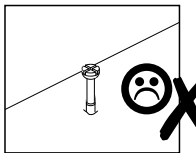
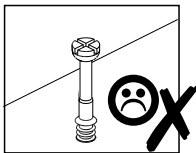
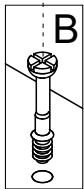
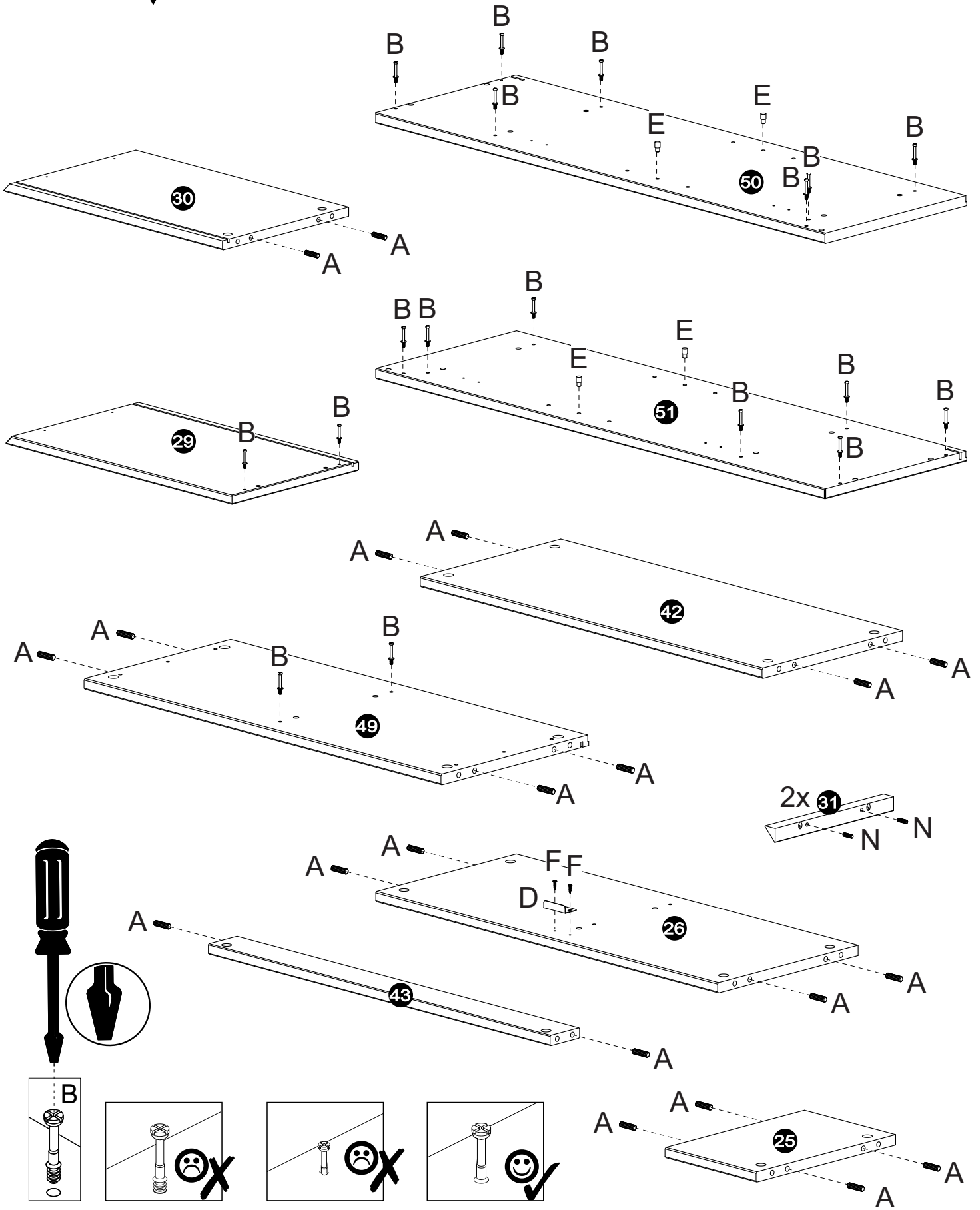
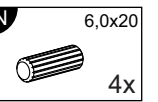
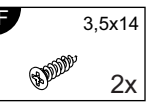
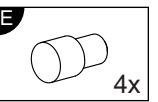
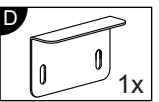
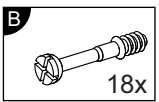
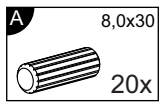

2

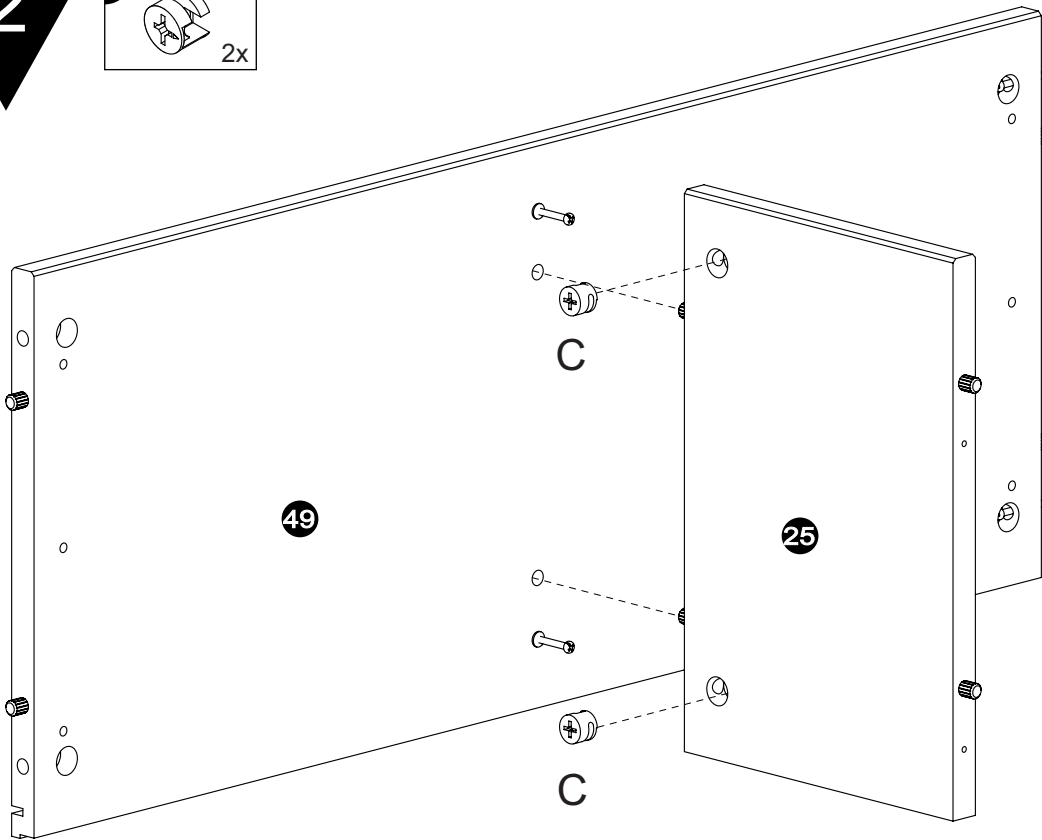
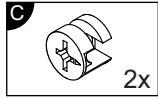

3

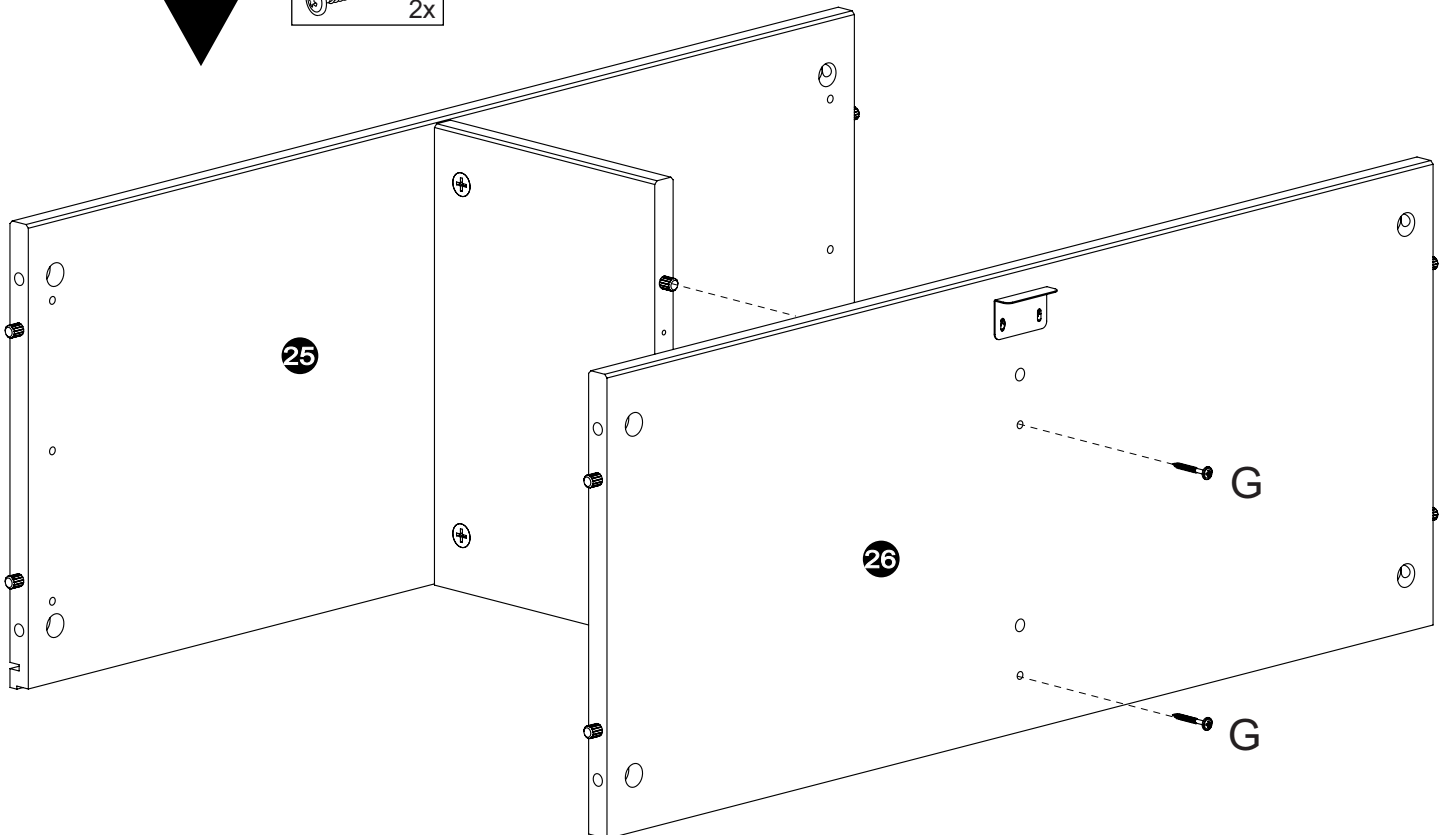
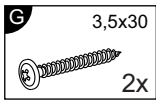

4

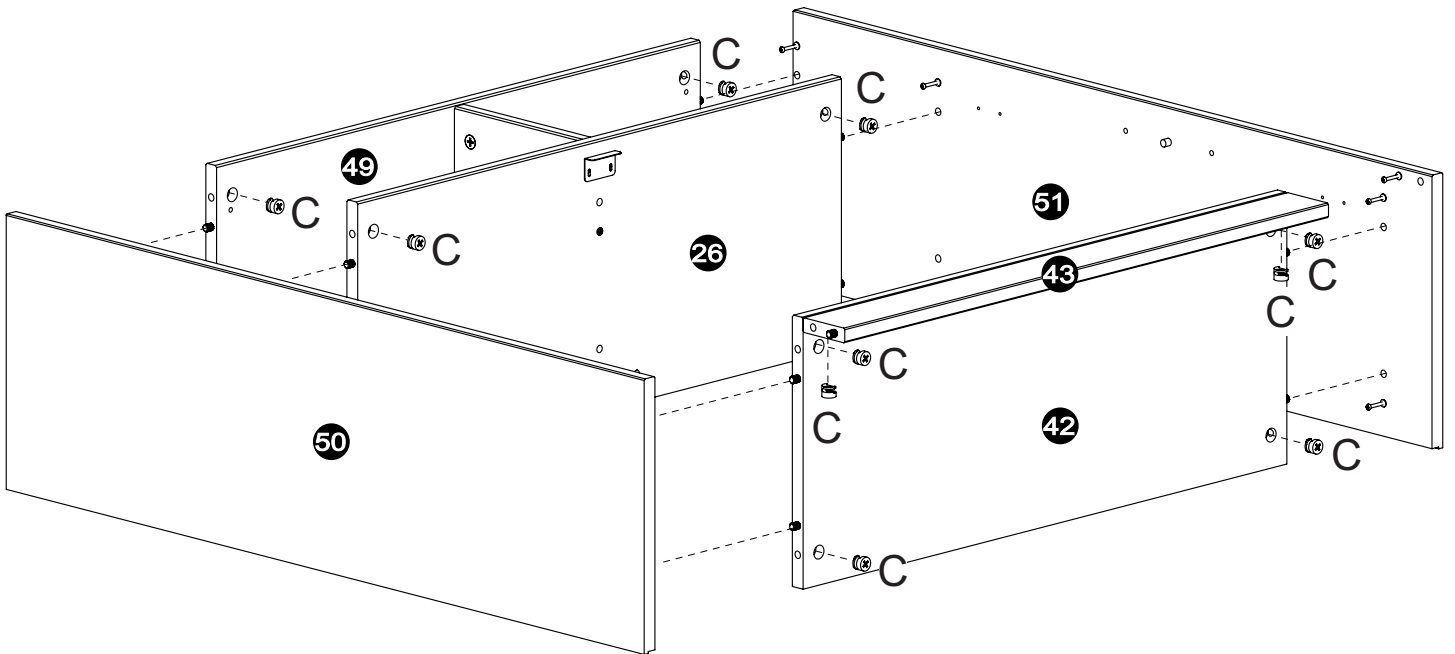
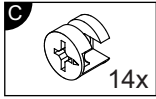

5

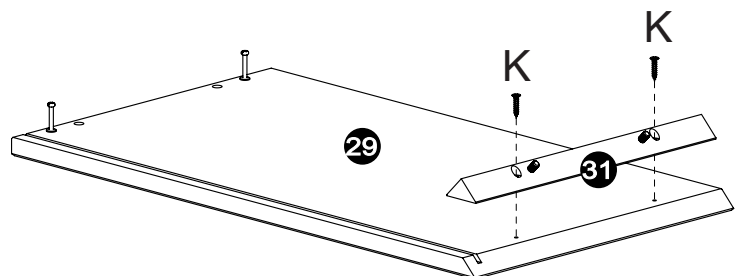
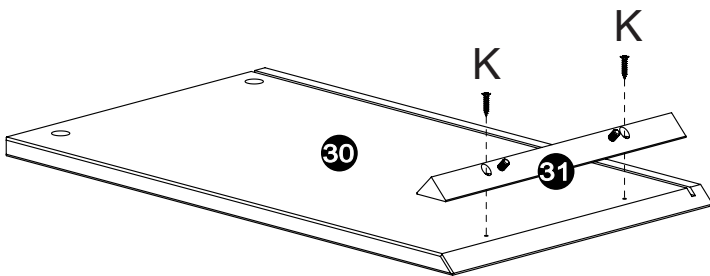
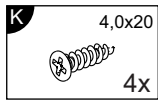

6

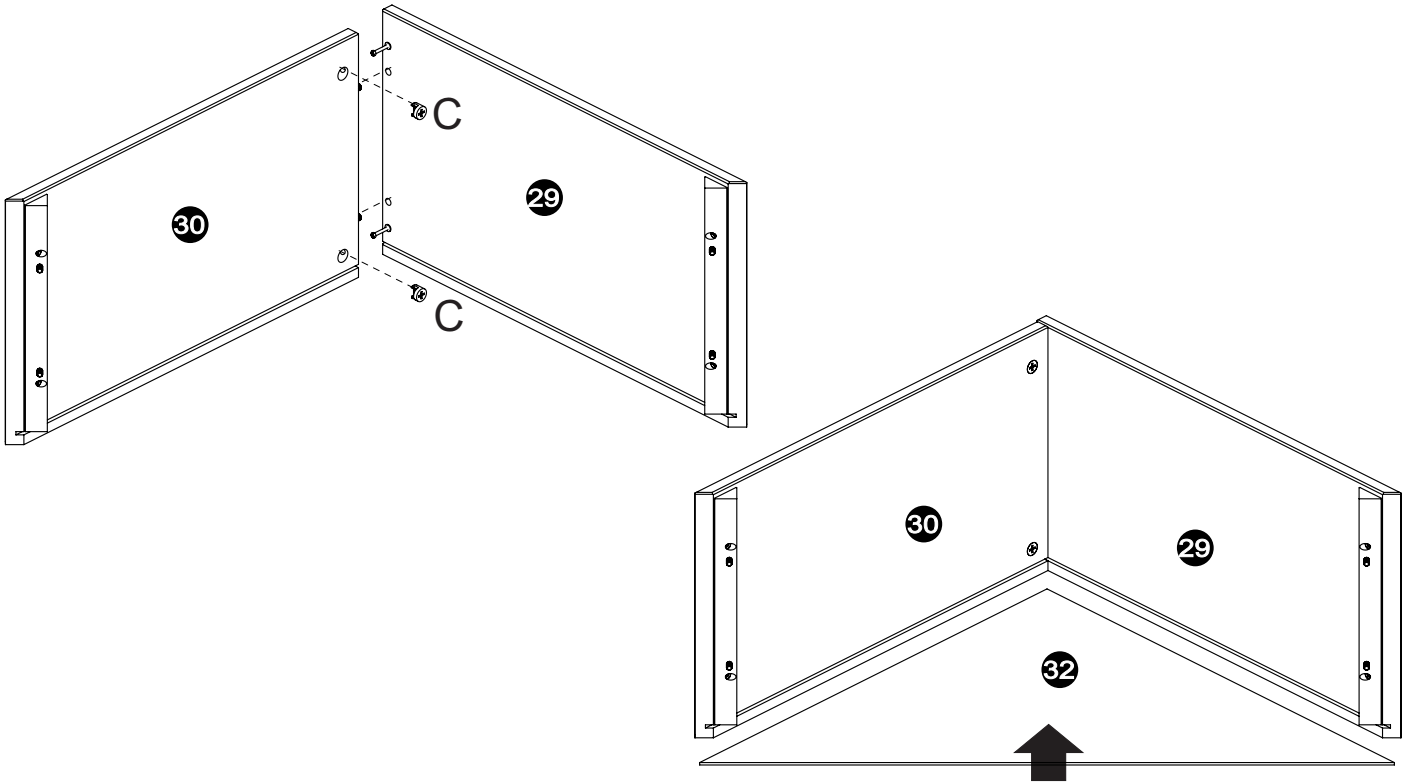
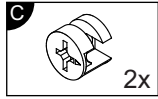

7

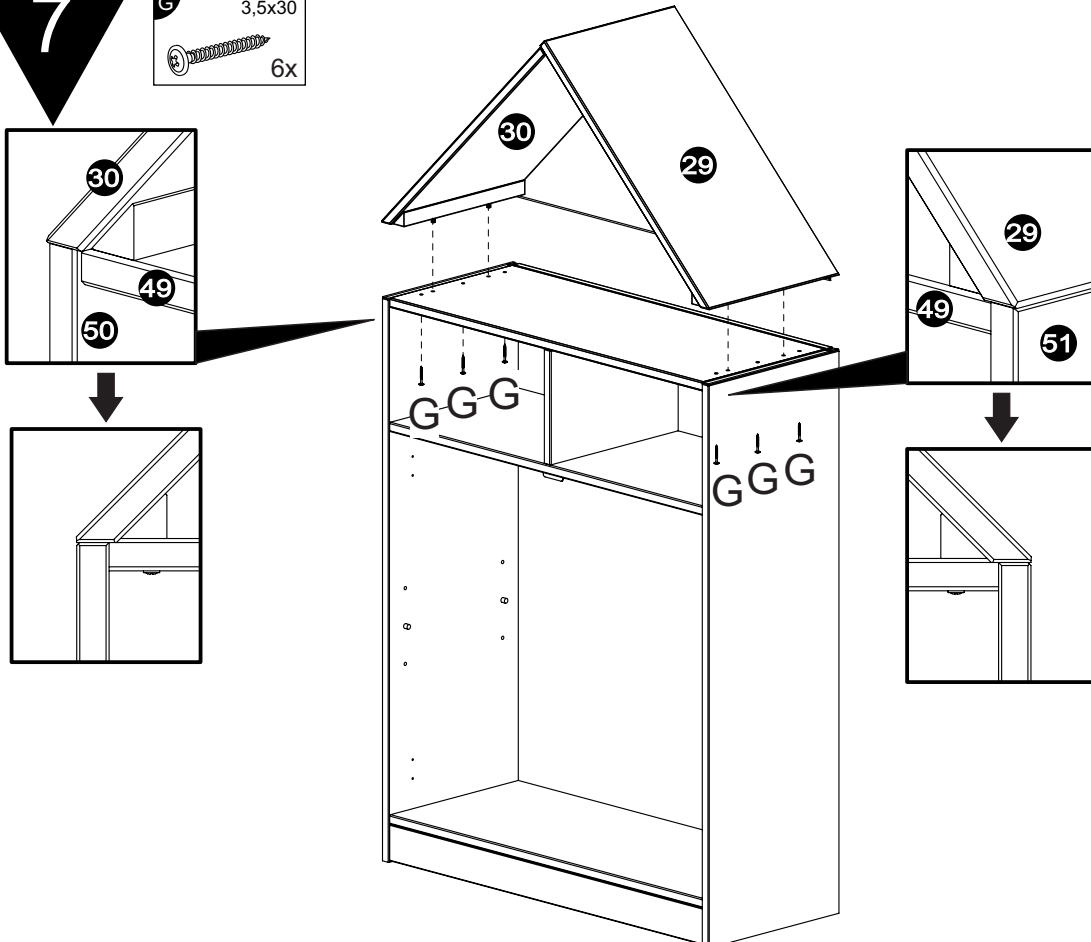
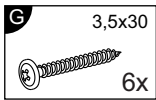

8

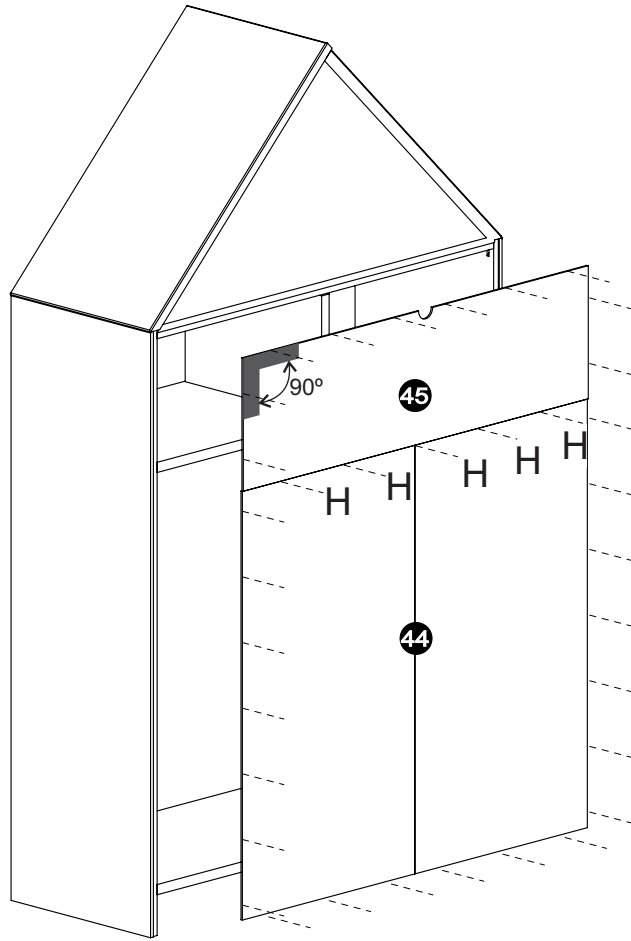
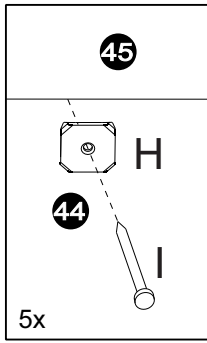
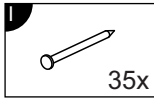
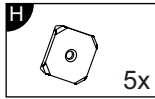

9

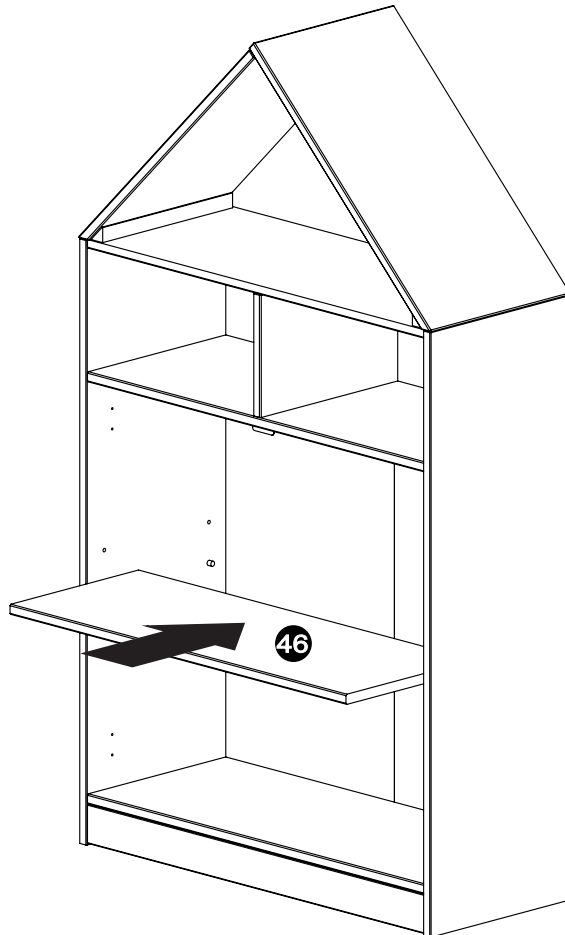

# 10

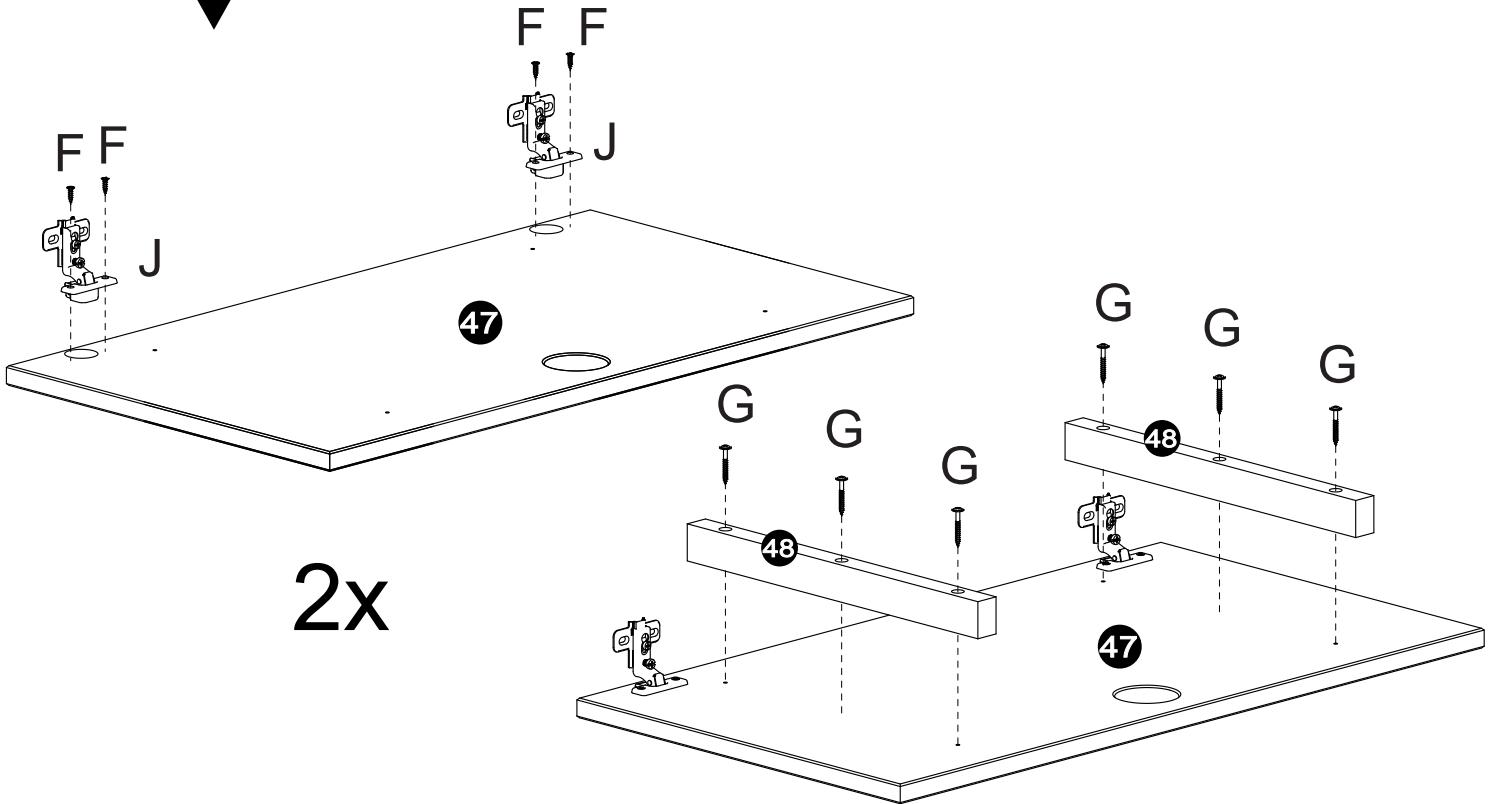
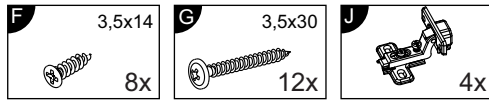

2x

# 11

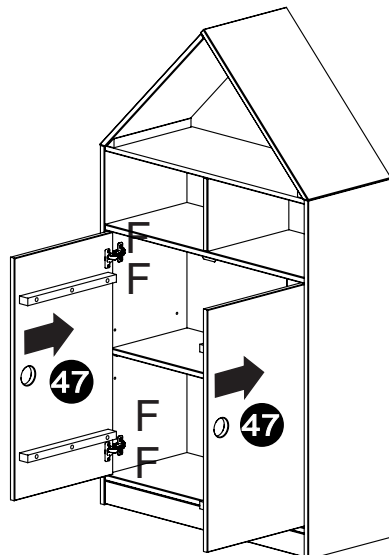
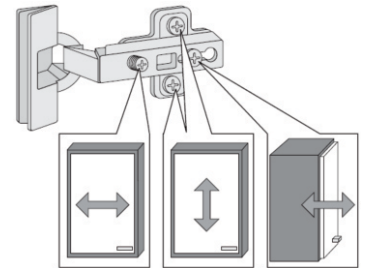
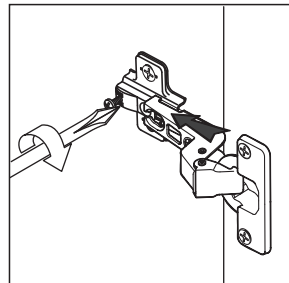
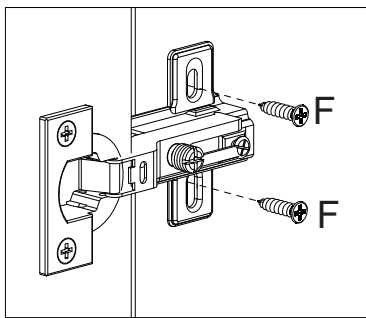
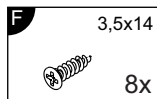

- Türen einstellen (Scharniere justieren)
- Adjusting the doors (adjusting the hinges)
- Régler les portes (ajuster les charnières)
- Sistemare le porte (regolare le cerniere)
- Deuren instellen (scharnieren afstellen)
- Nastawić drzwi (wyregulować zawiasy)
- Vyrovnejte dvířka (seřid'te závěsy)
- Nastavenie dverí (nastavenie závesov)
- Állítsa be az ajtókat (állítsa be a zsanérokot)
- Reglare uși (ajustare balamale)
- Kapıların ayarlanması (menteşelerin seviye ayarı)
- Регулировка Дверей (регулировка шарнира)



# 12

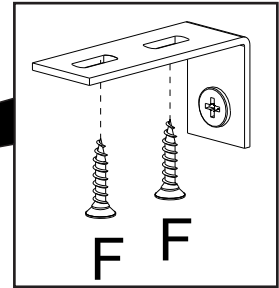
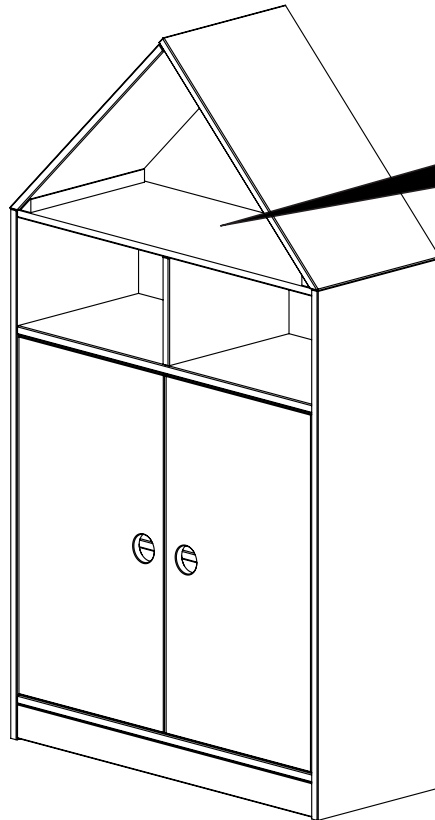
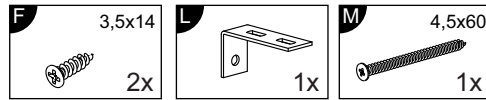

⚠ Achtung • Attention • Attenzione Opgelet • Uwaga • Pozor • Figyelem Atenție • Dikkat • Внимание ⚠	
(D)	Wandbefestigung dient als Kippschutz – unbedingt anbringen! Bei einigen Wandtypen kann ein Spezialdübel erforderlich sein!
(GB)	The wall fastening serves to prevent tipping – be absolutely sure to mount it! For certain wall types, a special wall plug may be necessary!
(FR)	La fixation murale sert de protection contre le basculement – à installer impérativement ! Pour certains types de murs il faut des chevilles spéciales !
(IT)	Il fissaggio alla parete serve da protezione anti-ribaltamento – attaccarla assolutamente! Per alcune strutture di parete può essere necessario un tassello speciale!
(NL)	Bevestiging aan de muur dient als kantelbescherming – zeker en vast bevestigen! Bij enkele muurtypes is een speciale plug misschien vereist!
(PL)	Mocowanie do ściany jest jednocześnie zabezpieczeniem przed przewróceniem – koniecznie zamontować! Do niektórych rodzajów ścian koniecznie zastosować specjalne kołki mocujące.
(CZ)	Montáž na stěnu slouží jako ochrana proti převrnutí – bezpodmienečně umístěte! U některých typů stěn může být zapotřebí speciální hmoždinka!
(SK)	Upevnenie na stenu slúži ako ochrana proti prevráteniu – bezpodmienečne použite! Pre niektoré druhy stien môže byť potrebná špeciálna hmoždinka!
(HU)	A termék a falhoz kel rögzíténi, különben az felborulhat! Egyes fal típusoknál speciális tiplit kell használni!
(RO)	Sistemul de fixare la perete servește ca protecție la răsturnare – de montat obligatoriu! Pentru unele tipuri de pereți este posibil să fie necesar un diblu special!
(TR)	Duvardaki sabitleme, devrilmeye karşı bir emniyet tedbiridir ve mutlaka monte edilmelidir! Bazı duvar tiplerinde bunun için özel bir dübel gerekli olabilir!
(RU)	Обязательно установите крепление на стене во избежание опрокидывания! Для некоторых типов стен может потребоваться специальный дюбель!

