

Modellname	Modellnummer	Typ
FRESH	 (01)04743347629218	4762921 Gästebad-Set Eiche hell bestehend aus Unterschrank, Keramik-Waschbecken und Spiegel mit LED-Leuchte

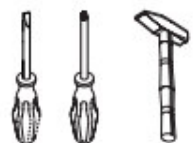
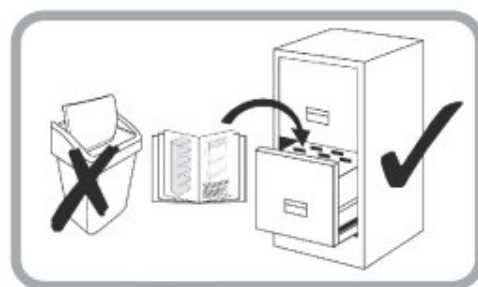
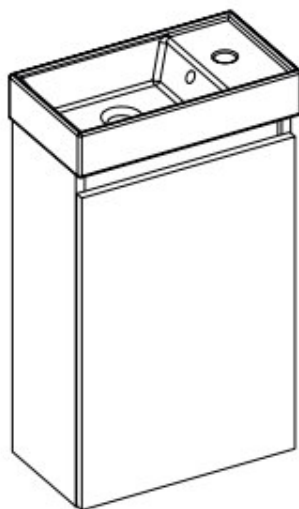
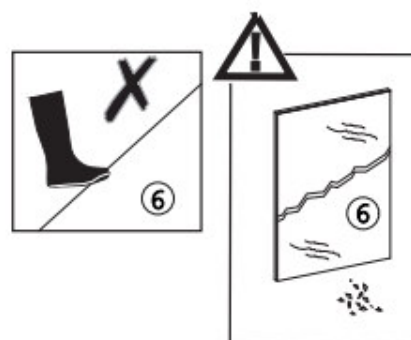
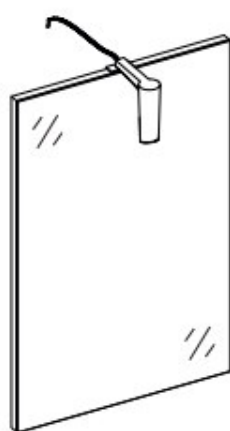
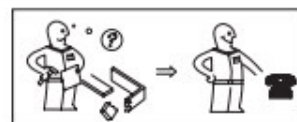
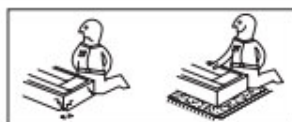

Modellname	Modellnummer	Typ
FRESH	 (01)04743347629218	4762921 Gästebad-Set Eiche hell bestehend aus Unterschrank, Keramik-Waschbecken und Spiegel mit LED-Leuchte

Unser Direktservice für Beschlagteile

Sollte Ihnen ein Beschlagteil fehlen oder Sie eine andere Beanstandung an Ihrem Möbel haben, wenden Sie sich bitte mit diesem ausgefüllten Blatt sowie gerne mit einem Bild per E-Mail an uns.

Grund der Beanstandung:

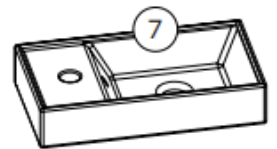
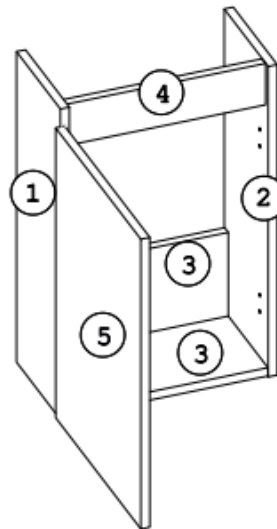











Name / Vorname

Straße





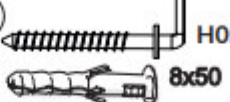



PLZ / Ort

Telefon / Email-Adresse

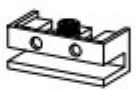
Modellname FRESH	Modellnummer  (01)04743347629218	Typ 4762921 Gästebad-Set Eiche hell bestehend aus Unterschrank, Keramik-Waschbecken und Spiegel mit LED-Leuchte
-----------------------------------	--	---

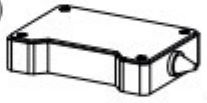
A1  Φ5x35 x6	A2  Φ15x12 x6	C3  x2
C4  Φ26 x2	D1  L x1	D2  R x1
F1  3,5x16 x4	F10+M1  6x60 10x50 x4	L2+M2  H05 8x50 x2
N1  x2		

O4

O4A  x1	O4B  3,5x16 x1	O4C1  x1
O4C2  3,5x10 3,5x18 x1	O4D  3,5x13 x1	O4E1  x1
O4E2  3,5x8 3,5x10 x1	  	

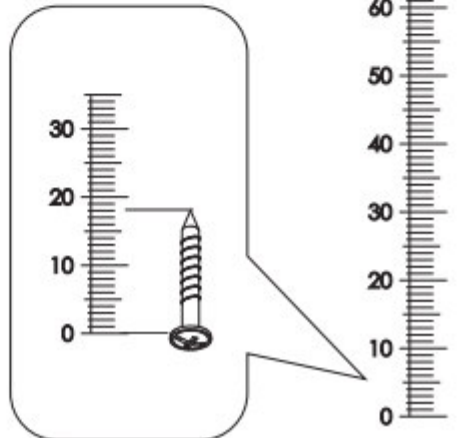

Sehr geehrter Kunde,

wir möchten Sie darüber informieren, dass eine Befestigung nur so gut ist wie die Verbindung zwischen Befestigungsmaterial (Dübel) und Mauerwerk. Prüfen Sie bei Hängeelementen Ihr Mauerwerk und verwenden Sie nur dafür vorgesehene Dübel. Letztendlich ist der Monteur für die Befestigung am Mauerwerk verantwortlich.

Die Montage und das Verlegen der Elektroartikel sind nur vom autorisiertem Fachpersonal durchzuführen. Beachten Sie die Beschreibungen und die Gewichtsangaben in der Montageanleitung.

Halten Sie bitte die angegebenen max. Gewichtsangaben ein. Bei Überlastungen, die durch spielende Kinder, Menschen, Material oder sonstige Einwirkungen entstehen übernehmen wir keine Haftung!

Die einwandfreie Funktion des Möbels ist nur bei lot- und waagerechter Aufstellung gewährleistet. Die Türen sind vorjustiert, müssen aber ggf. aufgrund örtlicher Bedingungen neu ausgerichtet / eingestellt werden.

Alle elektrischen Installationen sind nach den gültigen Normen bzw. Vorschriften von VDE, CE, MM gefertigt. Die zu verwendende Leuchtmittelstärke ist auf der jeweiligen Lampenfassung angegeben. Bei Nichteinhaltung der max. Wattzahl besteht durch Überhitzung Brandgefahr. Das Zudecken der Leuchtmittel ist wegen Brandgefahr zu unterlassen!

Alle Schrauben sowie tragende Verbindungsstellen sollten nach 5 bis 6 Wochen nachgezogen werden, um eine dauerhafte Standsicherheit zu gewährleisten!

Bitte verwenden Sie keine scheuernden Putzmittel!

Werden Betriebs-, Bedienungs- oder Montageanweisungen nicht befolgt, Änderungen an den Produkten vorgenommen, Teile ausgewechselt oder Verbrauchsmaterialien verwendet, die nicht den Originalteilen entsprechen, so entfällt jegliche Gewährleistung oder Haftungsansprüche.

Pflegehinweis für Möbel-Hochglanzfronten

Die Hochglanzoberflächen sind bei der Auslieferung durch eine Schutzfolie geschützt. Belassen Sie diese auf dem Möbel, bis es vollständig montiert und von Staub befreit ist.

Um die wertvolle Hochglanzoptik zu erhalten, sollten Sie der Hochglanzfolie nach der Entfernung der Schutzfolie eine Stunde Zeit zum Nachhärten an der Raumluft geben.

Für die Reinigung der Oberflächen verwenden Sie nur ein feuchtes Baumwolltuch und etwas Glasreiniger. Kein scharfes Reinigungsmittel mit Zusatzstoffen verwenden!

Oberflächen mit einem nassen Lappen abreiben, keinen Dampfreiniger verwenden!

Oberflächen nicht mit scharfen Gegenständen beschädigen und auf gar keinen Fall starker Sonnenbestrahlung aussetzen.

Wir wünschen Ihnen noch viel Freude mit Ihrem neuen Möbel!

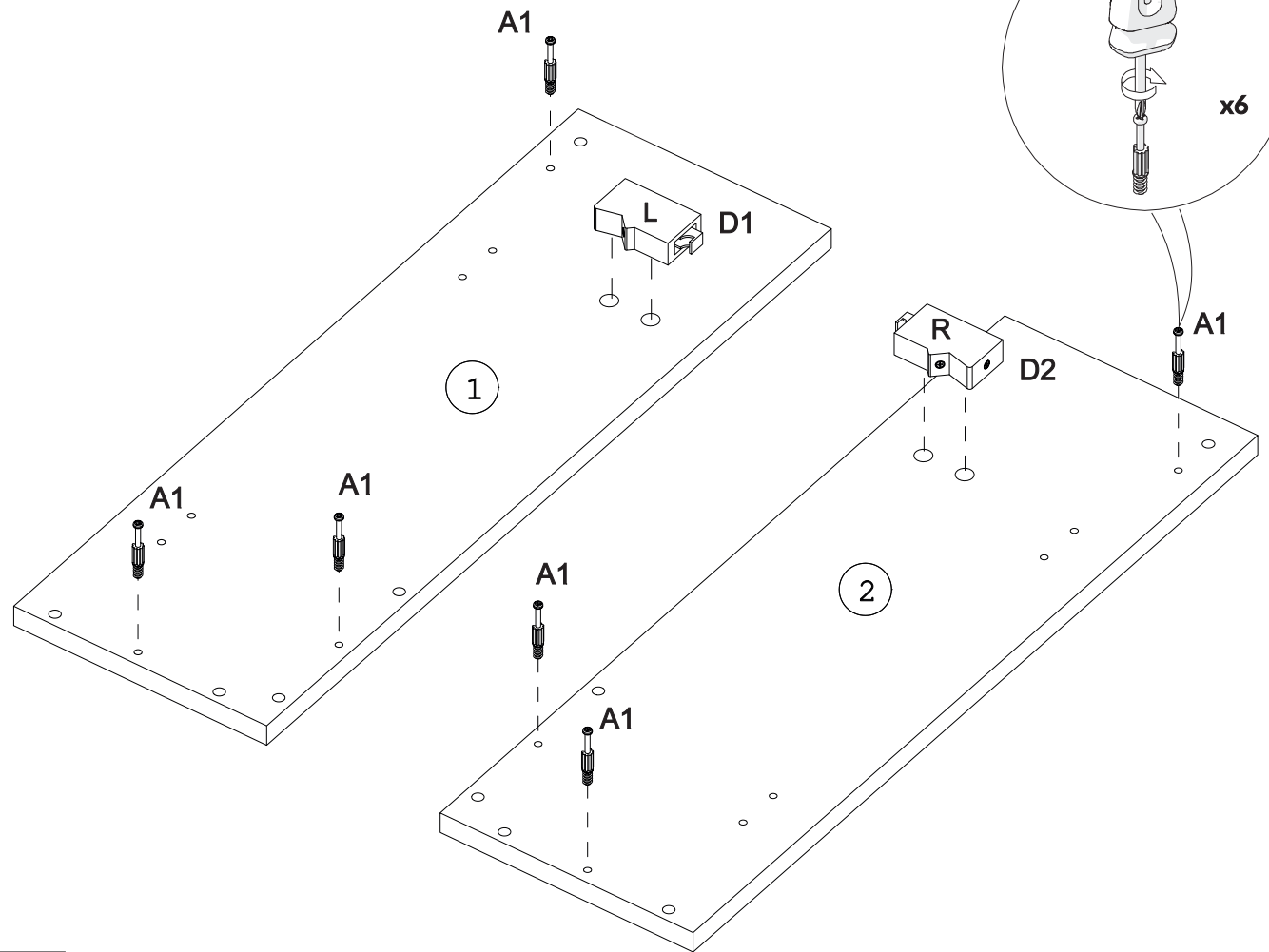
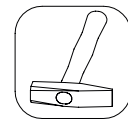
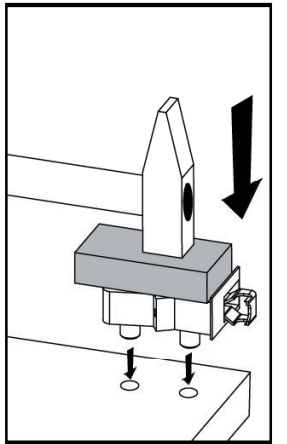
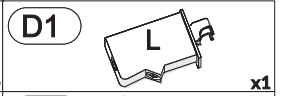
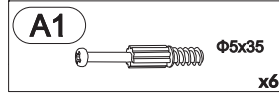
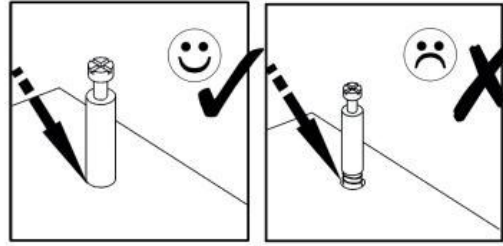
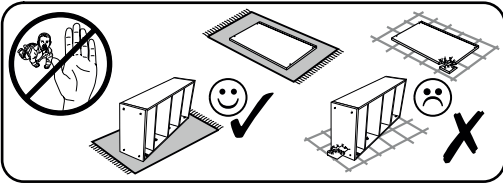

1

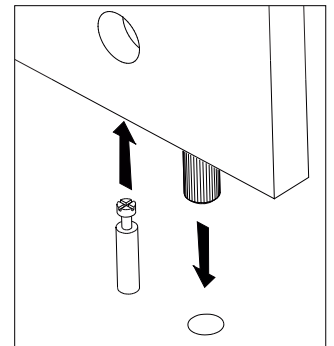
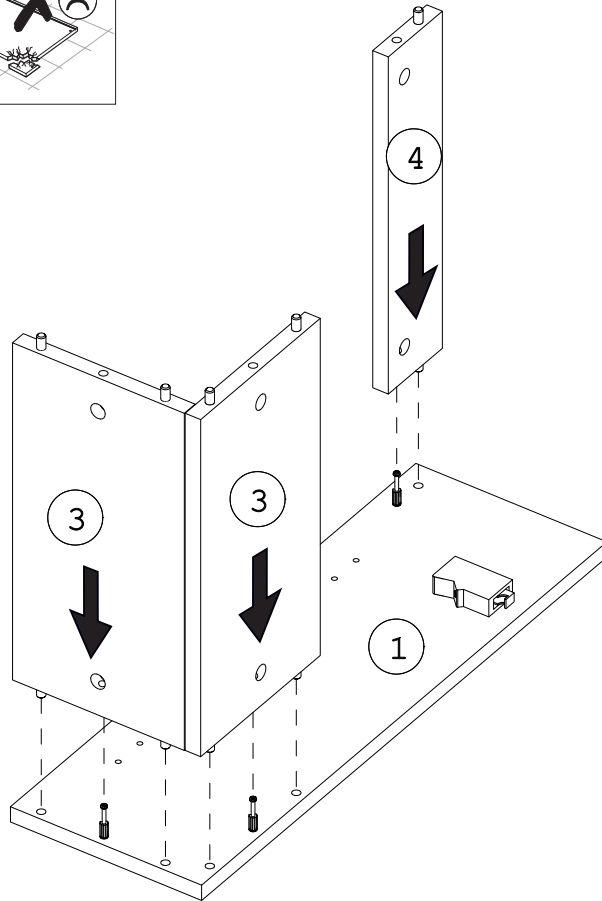
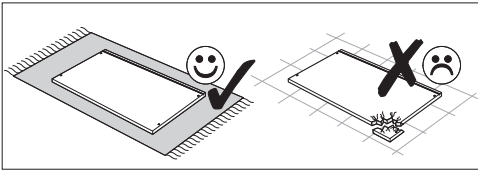

2

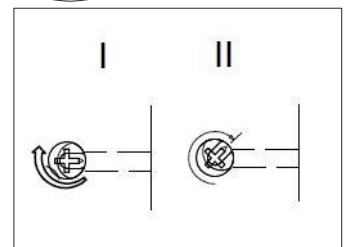
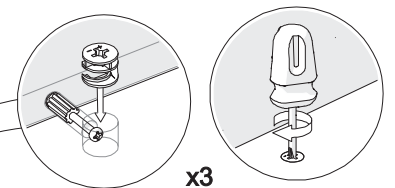
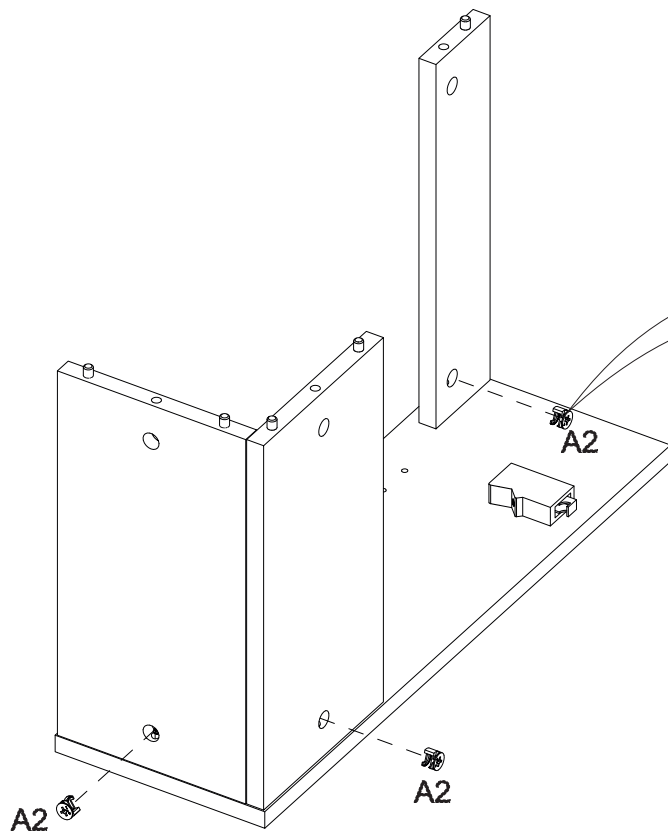
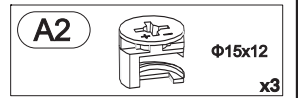

3

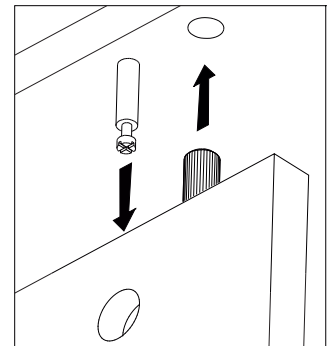
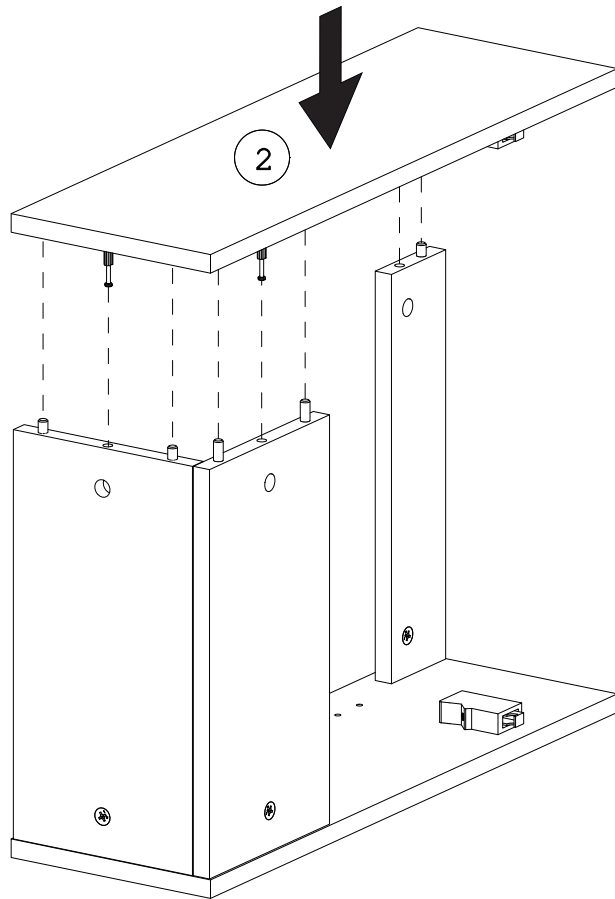

4

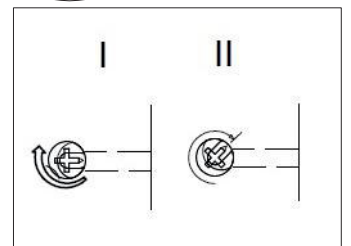
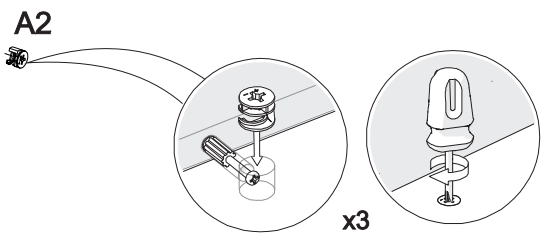
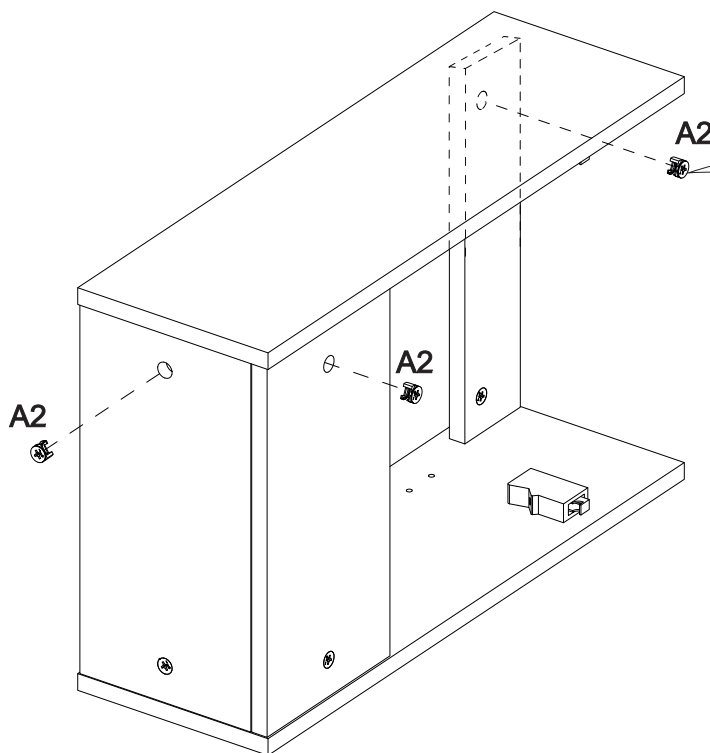
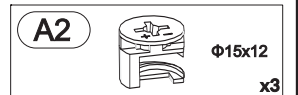

5

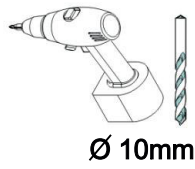
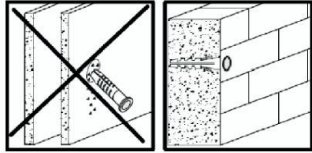

Ø 10mm

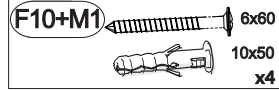

N1



x2

B

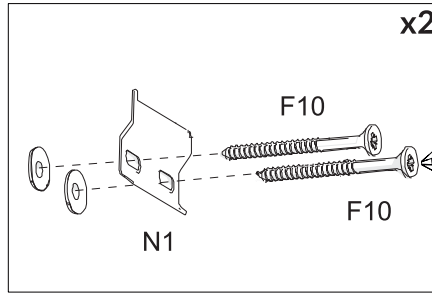
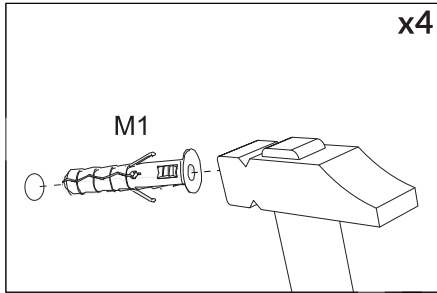

A

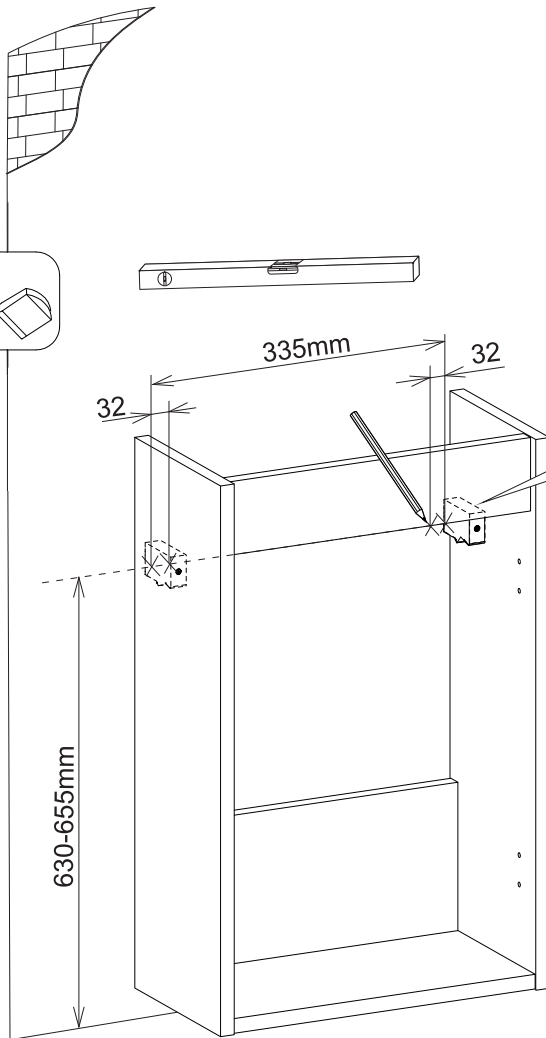

C

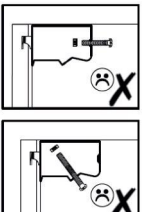
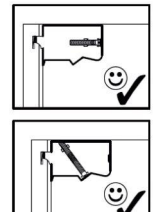
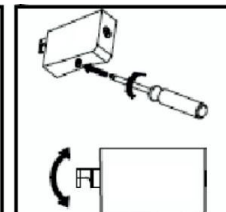
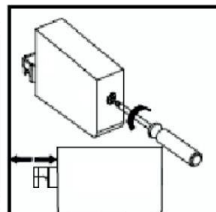
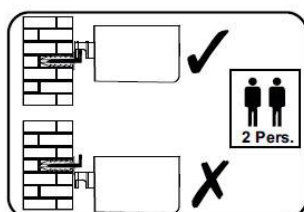
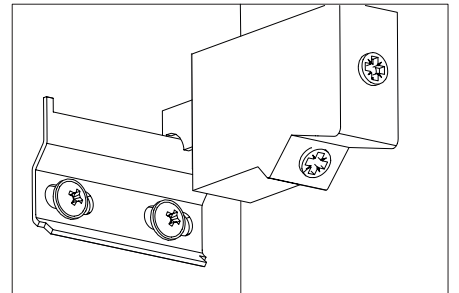
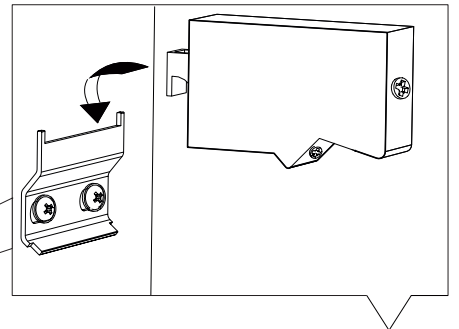

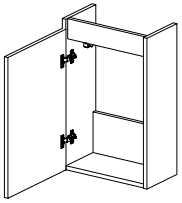

L

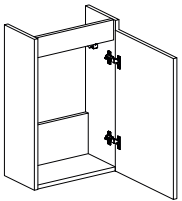
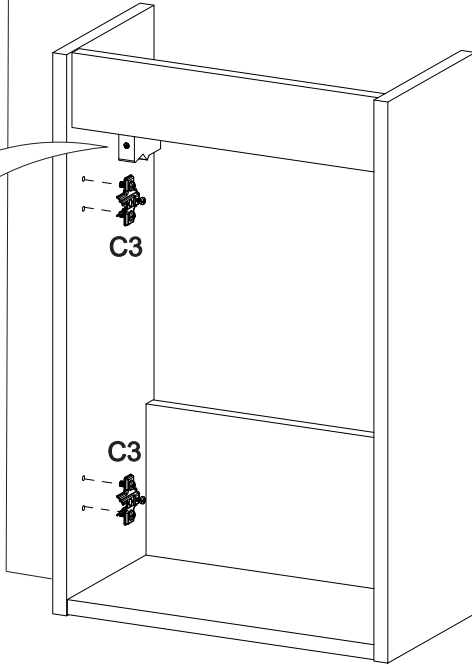
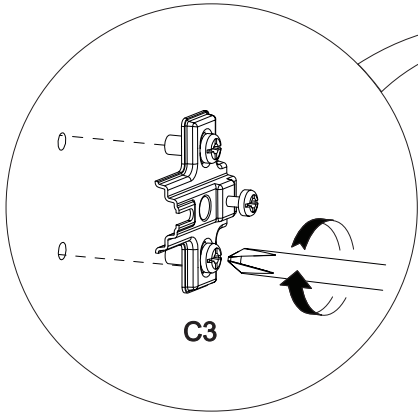
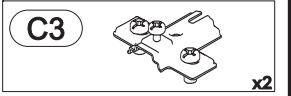
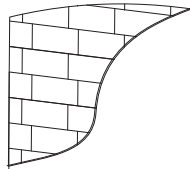

R

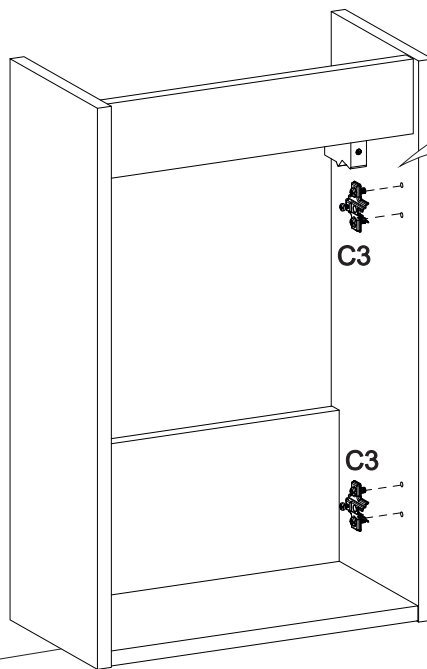
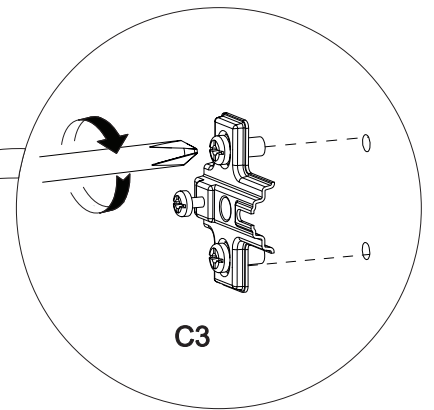
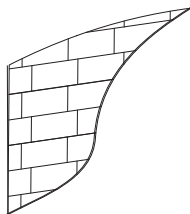

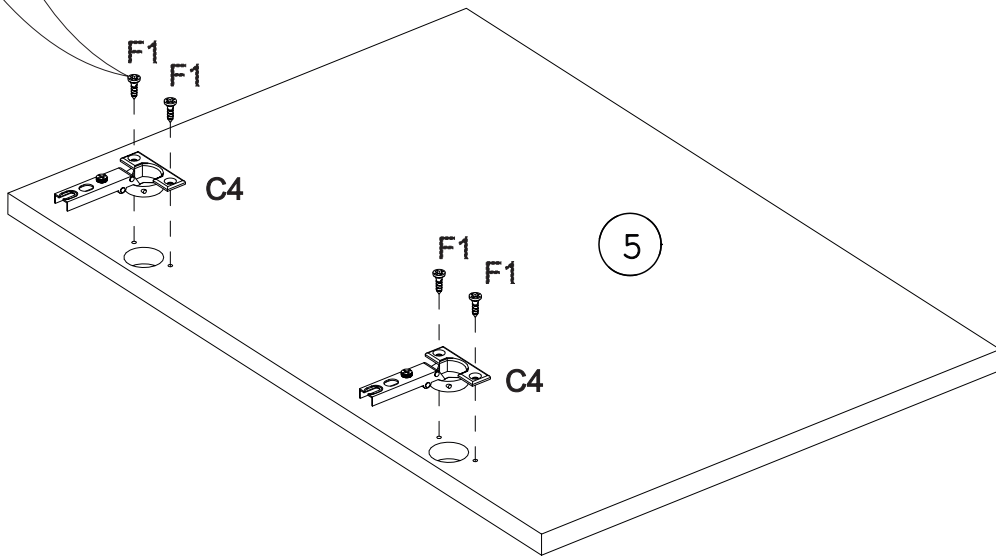
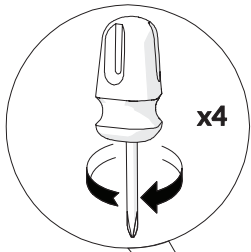
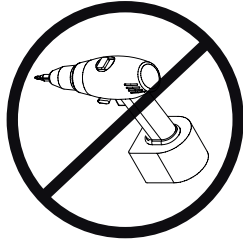
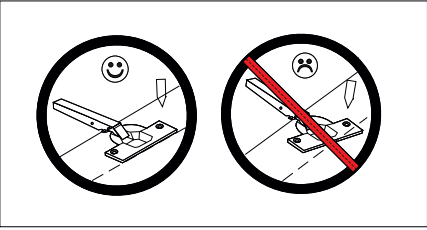
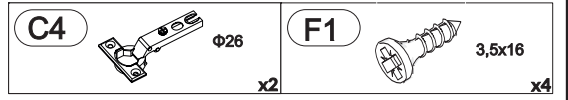
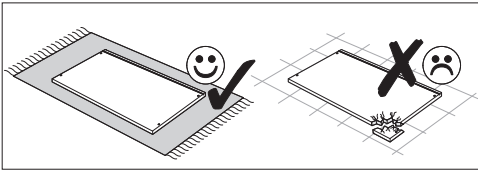

L

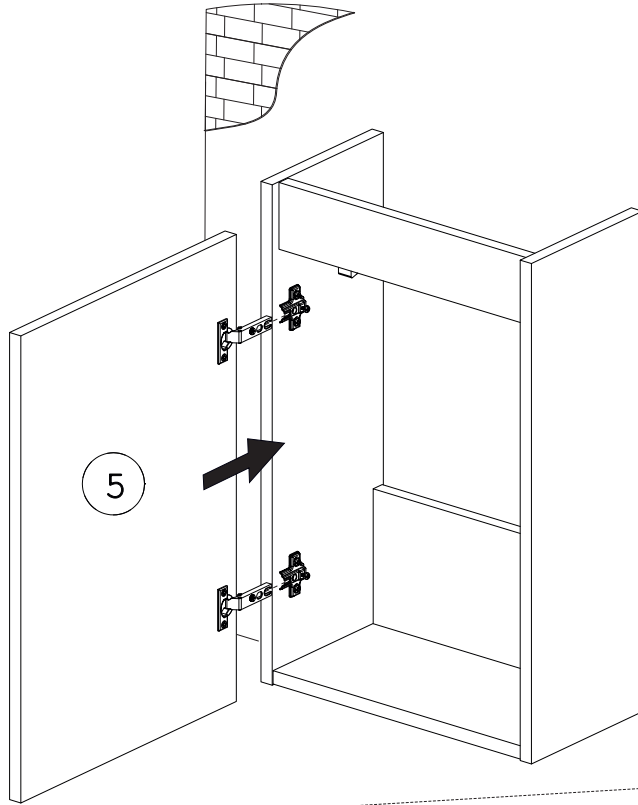

R

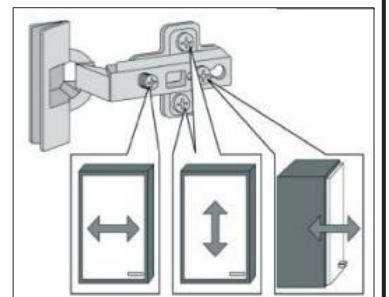
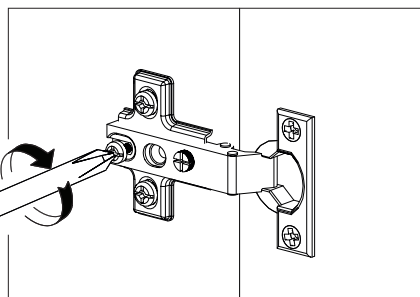
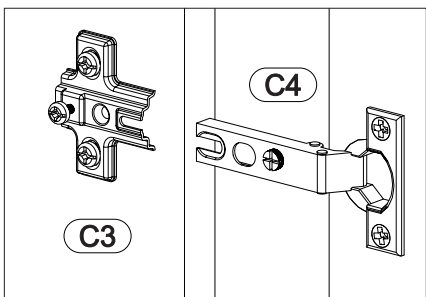
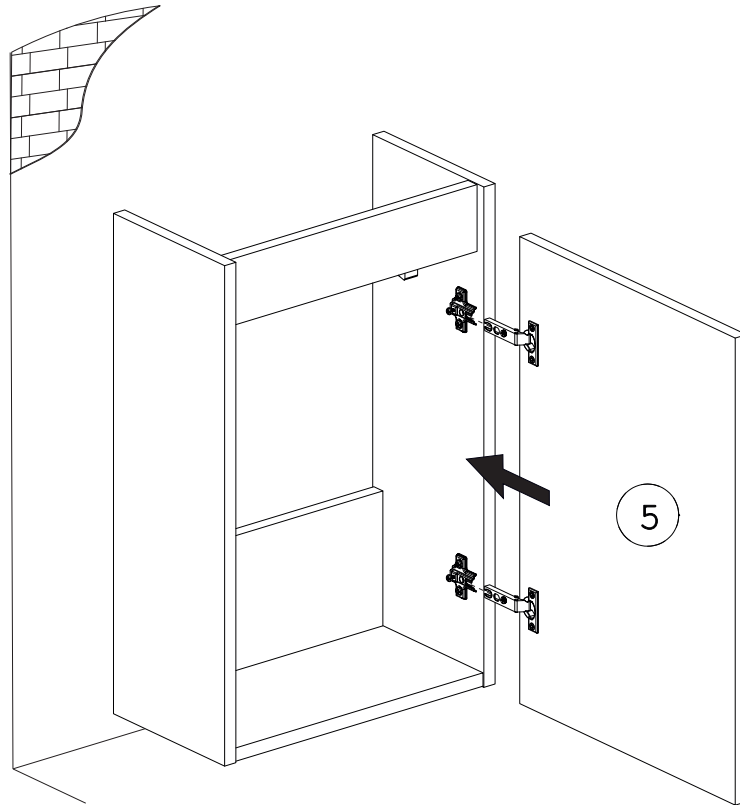

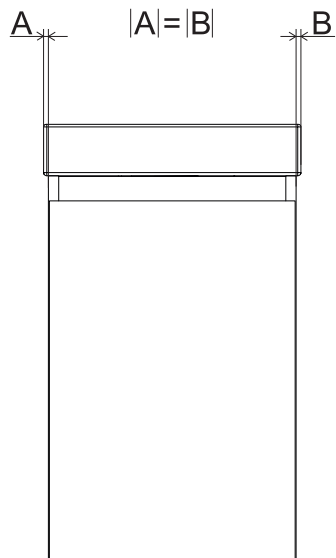
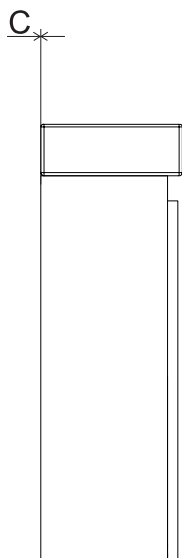
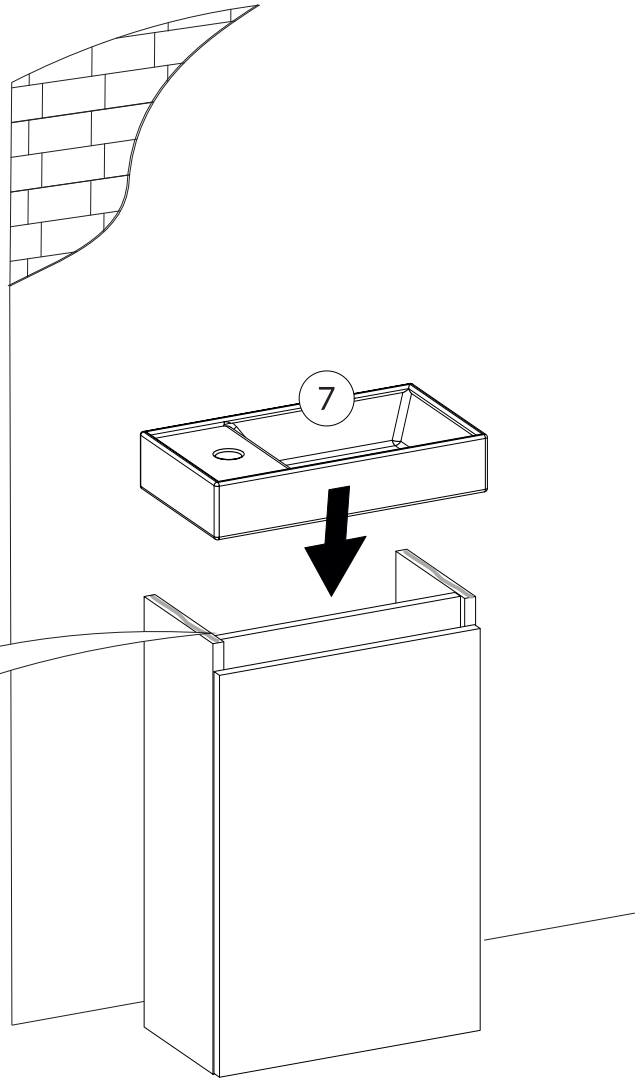
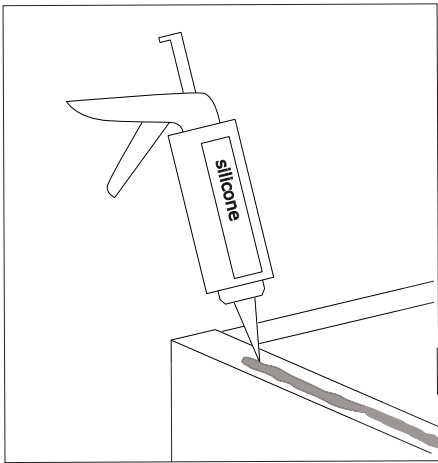

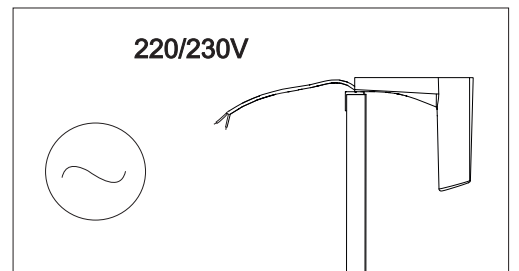
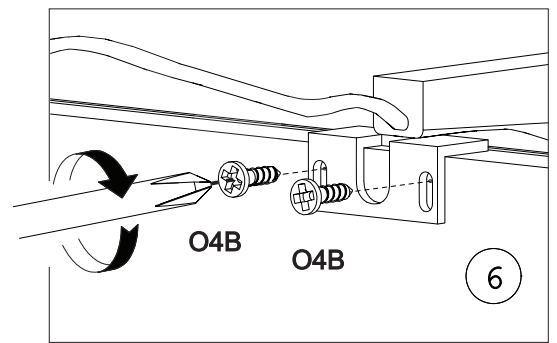
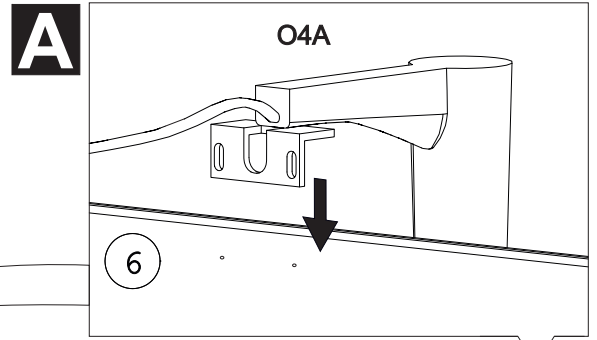
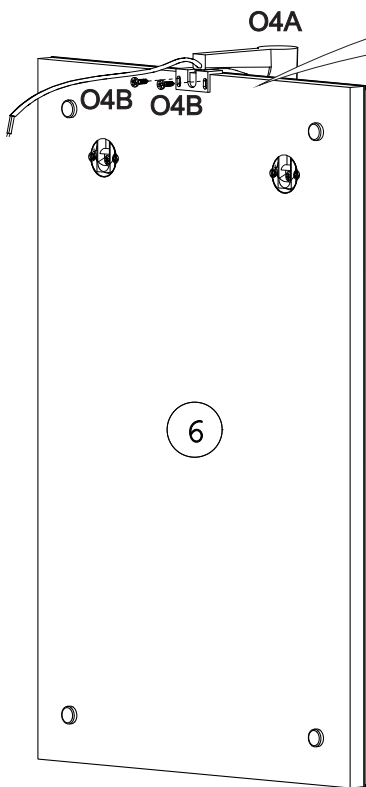
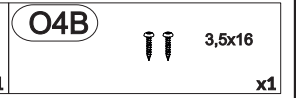
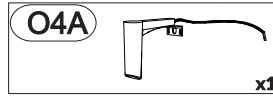
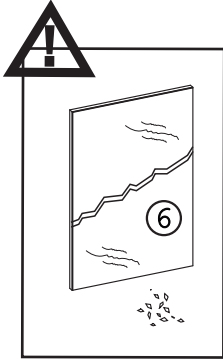
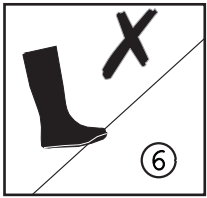

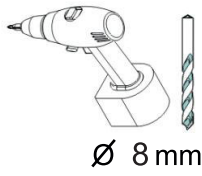
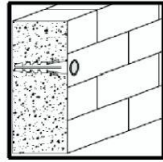
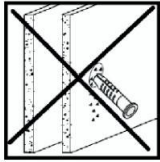

∅ 8 mm

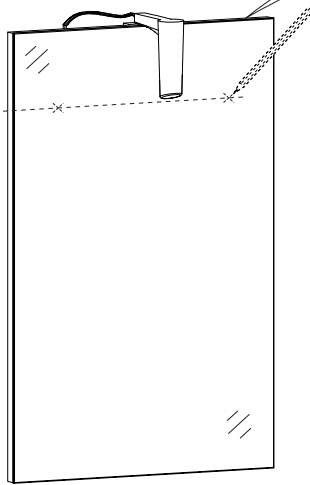
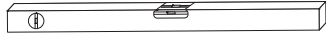
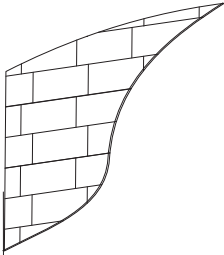
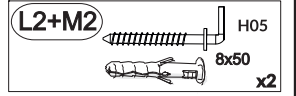

1765-1815mm

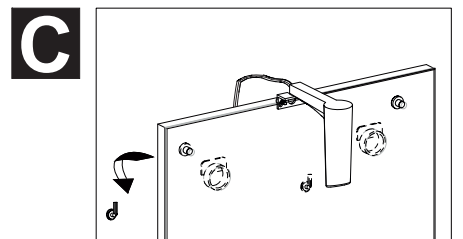
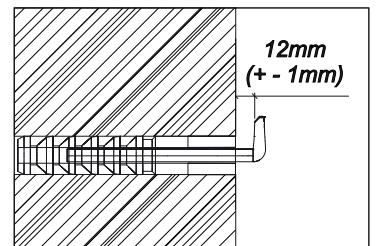
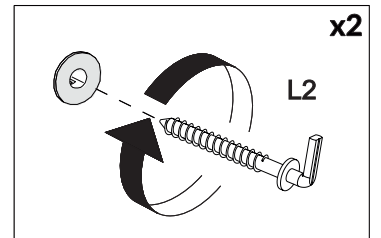
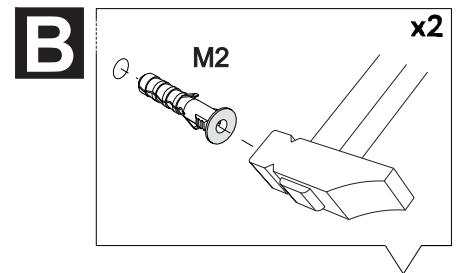
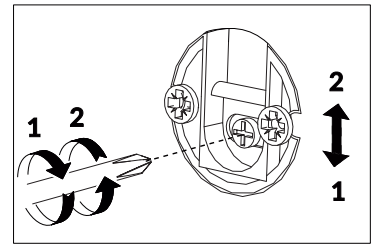
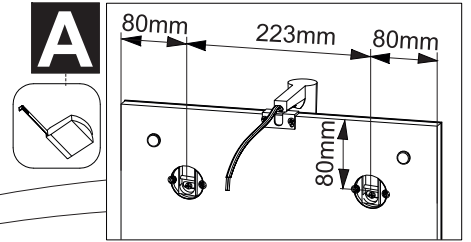
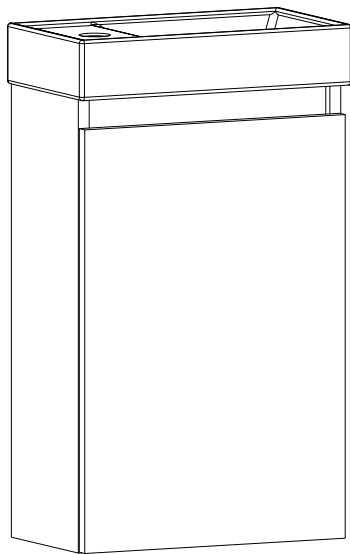

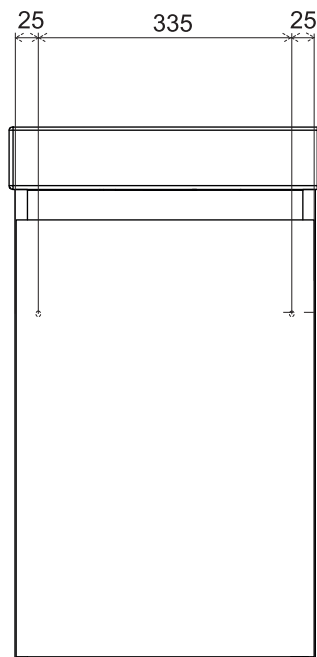
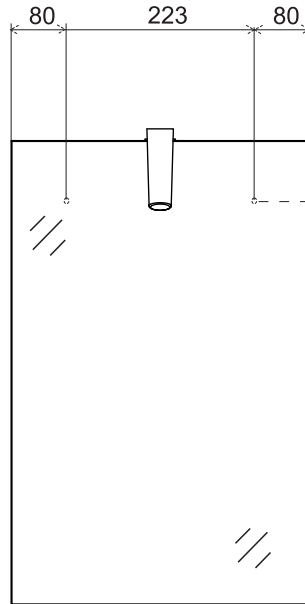

1765-1815mm

630-655mm

