



(D) Montageanleitung

(FR) Notice de montage

(NL) Handleiding voor de montage

(CZ) Montážní návod

(HU) Szerelési útmutató

(TR) Montaj talimatı

(GB) Assembly instructions

(IT) Istruzioni di montaggio

(PL) Instrukcja montażu

(SK) Návod na montáž

(RO) Instrucțiuni de montaj

(RU) Инструкция по монтажу

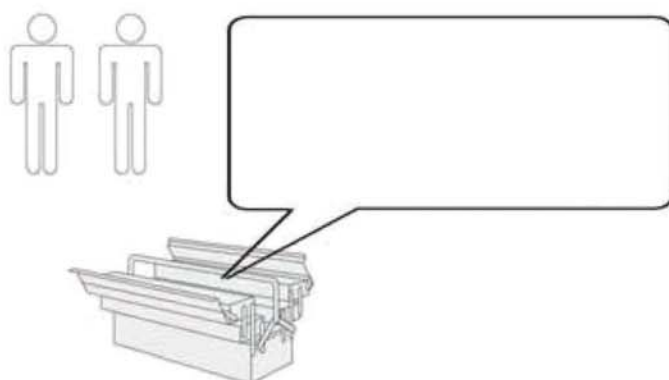

0
10
20
30
40
50
60
70
80
90
100
110
120
130
140
150
160
170
180
190
200

Service • Assistenza • Dienstverlening • Serwis Servis • Szerviz • Сервисная служба		
Name • Nom • Nome • Naam Nazwa • Jméno • Názov • Név Denumire • İsim • Название	THERON	
Nr. • No. • N° • Номер • С • Sz		
Typ • Type • Tip • Tipus • Tipo Тип	ST32113	

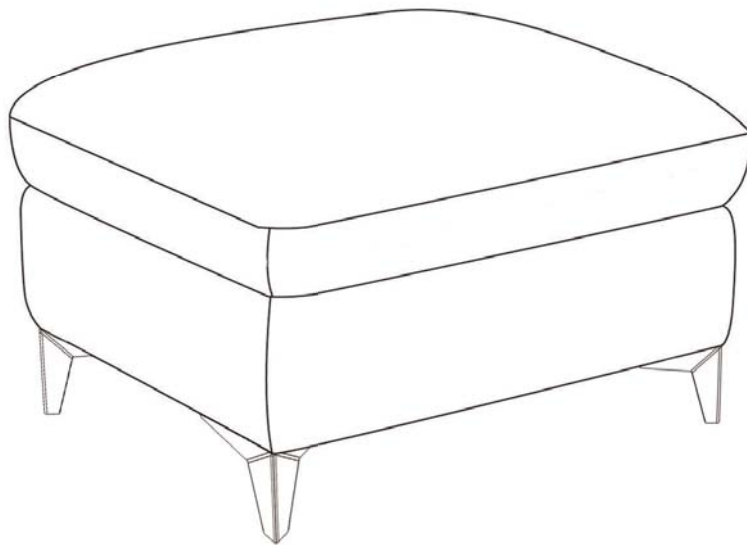

X4PC

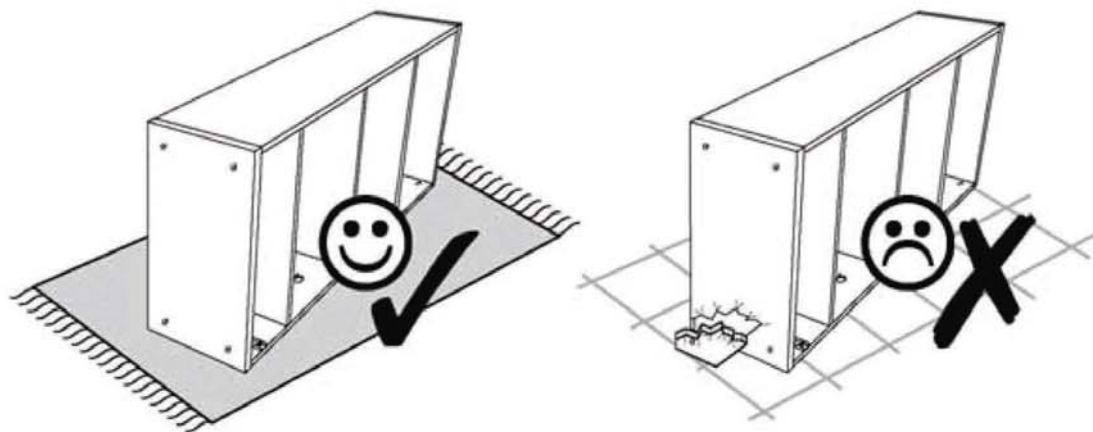

A M8*30B	B -8B	C 5A
X8	X8	X1

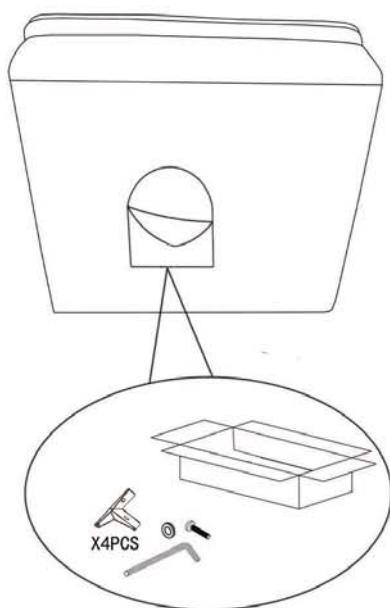

1



2

A M8*30B	B -8B	C 5A
		
X8	X8	X1

